

CB ROUNDUP — DIGITAL CLOCKS — IC APPLICATIONS

\$1.00 ■ SEPT. 1976

Radio-Electronics

THE MAGAZINE FOR NEW IDEAS IN ELECTRONICS

see the new
CB ANTENNAS
for your car

circuits show
IC APPLICATIONS
for 555 timers

from our lab
HI-FI TESTS
of new gear

pick-tock
DIGITAL CLOCKS
them all

561256 QLS 80245497 14 A MAR77
H H DELSCHLAGER 09
BOX 245
BROWNS HILLS NJ 08015

GERNSBACK
PUBLICATION

PLUS — Bucket Brigade Time Delay ★ Selecting & Installing
TV Antennas ★ Mindpower: Alpha ★ State Of Solid State ★
Digital Countdown Timer ★ Step-By-Step Troubleshooting ★
Jack Darr's Service Clinic ★ Komputer Korner

THE BEST OF EVERYTHING HAS ITS PRICE ...EVEN TUNER SERVICE!

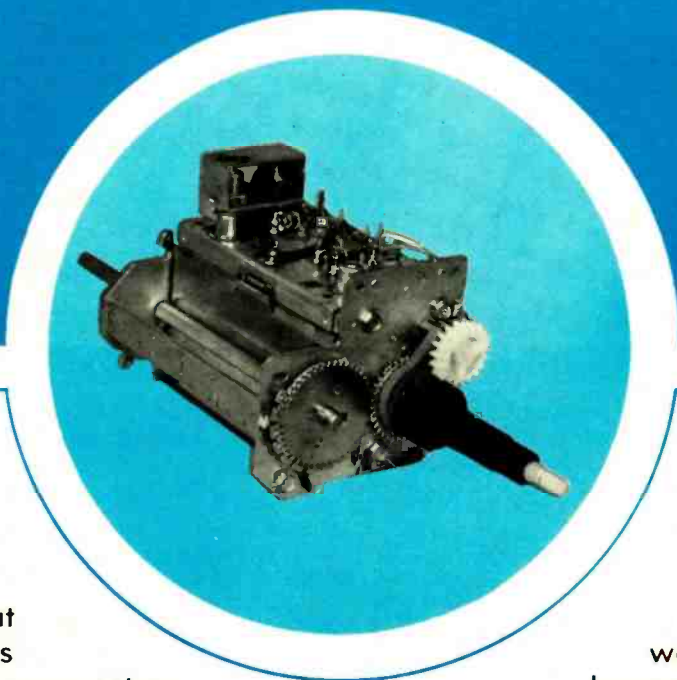

From the beginning, our goal has been to provide the best tuner service—never the cheapest. You get what you pay for in business and tuner service is no exception. The extra dollar you might pay at PTS is peanuts when you consider the added

reliability and the standards of excellence we apply to every job. Thousands of PTS customers must agree or we wouldn't be the world's largest tuner service company. When you are comparing tuner service companies, price alone doesn't tell the story.

SAME DAY SERVICE • ORIGINAL PARTS • ONE YEAR GUARANTEE

WE REPAIR THEM ALL . . . COLOR, BLACK & WHITE, TUBE, TRANSISTOR OR VARACTOR . . . ANY MAKE OR MODEL.

VHF or UHF. . . \$10.95 UV-Comb. . . \$17.95

(MAJOR PARTS AND SHIPPING EXTRA — DEALER NET)



PTS ELECTRONICS, INC.

PRECISION TUNER SERVICE

General Headquarters: P.O. Box 272, Bloomington, IN 47401

Consult the white pages of your telephone directory for the address and number of your nearest PTS Service Center.

MIDWEST
Bloomington, IN
Indianapolis
Cleveland
Cincinnati
Columbus
Kansas City, KS
Minneapolis

St. Louis
Detroit
Grand Rapids
Milwaukee
Davenport
NORTHEAST
Springfield, MA

Philadelphia
Pittsburgh
E. Paterson
Buffalo
Boston
Syracuse
SOUTH
Jacksonville

Washington, DC
Charlotte
Birmingham
Memphis
Norfolk
New Orleans
Tampa
Nashville

SOUTHWEST
Longview
Houston
Oklahoma City
MOUNTAIN
Denver
Salt Lake City
Phoenix

PACIFIC
Sacramento
San Diego
Los Angeles
Portland
Seattle
CANADA
Montreal

The small wonder



of the micro-World

Measuring just 11" wide x 11" deep x 5" high, and weighing a mere 7 pounds, the Altair™ 680b is a complete, general-purpose computer.

The secret to this revolutionary, small computer is its CPU board. This double-sided board fits along the bottom of the Altair case and plugs directly into the front panel board. It contains the new 6800 microprocessor, 1,024 bytes of RAM memory, a 256 byte PROM monitor, provisions for 768 bytes of additional PROM or ROM, and a single Interface port with a Motorola ACIA serial interface adapter which can be configured either RS-232 or TTY. A five level Baudot interface option is also available.

The Altair 680b can be programmed from front panel switches, or it can be interfaced to a video display terminal, or teletypewriter. Three additional circuit boards can be plugged inside the Altair 680b for further memory and interface expansion. The first of these boards is a 16K static RAM memory board.

Software already developed includes Altair 680 BASIC with all the features of the 8K BASIC previously developed for the Altair 8800. These include Boolean operators, the ability to read or write a byte from any I/O port or memory location, multiple statements per line, and the ability to interrupt program execution and then continue after the examination of variable values. This software takes only 6.8K bytes of memory space and a copy is included free with the purchase of the Altair 680 16K memory board.

Other software includes a resident two pass assembler (also free with 16K board). The Altair 680b is also compatible with Motorola 6800 software.

The Altair 680b is ideal for hobbyists who want a powerful computer system at an economic price. Altair 680b owners qualify

for membership in the Altair Users Group, and like other Altair owners, they receive a complimentary subscription to **Computer Notes** and complete factory support.

PRICES:

Altair 680b kit with complete, easy-to-understand assembly manual, operator's manual, and programming manual.....	\$466
Assembled Altair 680b.....	\$625
Altair 680b Turnkey model kit.....	\$395
Expander Card 680MB (required to expand 680).....	\$ 24
Altair 680BSM 16K static RAM board kit with 680 BASIC.....	\$685
Altair 680 BASIC when purchased separately.....	\$200
Baudot option.....	\$ 42

MAIL THIS COUPON TODAY

- Enclosed is a check for \$ _____
- BankAmericard # _____ or Master Charge # _____
- Altair 680b Kit Assembled Other (specify) _____
- enclose \$8 for postage and handling (Continental U.S. Others subject to quote)
- Please send free information package.

NAME _____

ADDRESS _____

CITY _____ STATE & ZIP _____



2450 Alamo SE/Albuquerque, NM 87106, 505-243-7821

NOTE: Altair is a trademark of MITS, Inc.

Price, specifications subject to change. Please allow up to 60 days for delivery

Circle 47 on reader service card

Our testimonials are so great, you might think we twisted people's arms to get them.

"Best line availability... No comparison to other brands." James Cal Pumphrey, Woodward & Lothrop—Springfield, Virginia.

"We use Sylvania for 90% of picture tube replacements and have not had any dissatisfied customers." Harold Hollis, Benzie-Shook TV—Denver, Colorado.

"Quality, they satisfy my customers and reduce callbacks." William Stanek, Stanek Electronics Labs—Manchester, Conn.

"We have always been satisfied with Sylvania tubes." Mareck Bajana, Ken Crane's Magna City—Hawthorne, California.

"Good color contrast and brightness." Russell Treslor, Tele-Radio Service Co.—Birmingham, Alabama.

"Good quality makes the product easy to sell."

Harry Murray, Murray's Television Service—King of Prussia Pa.

"I have had good results and very few failures."

Bobby Jones, Camilla TV Service—Camilla, Georgia.

"Have very few replacements when I use Sylvania—good quality."

Robert Wayne, Accurate Television—Parma, Ohio.

"We use Sylvania picture tubes over all others regardless of price."

Jesse Spain, Spain TV—Pasadena, Texas.

Not one of these picture tube testimonials was acquired under pressure.

We didn't even ask people to say something nice.

The results were pretty impressive.

Dealers and Service Technicians talked freely about the quality of our picture tubes, low number of callbacks, and the breadth and availability of our line.

If a Sylvania salesman comes around to your store, be sure to tell him, honestly and straightforwardly, what you think of our picture tubes.

We promise not to use any rough stuff.

GTE SYLVANIA

Radio-Electronics®

THE MAGAZINE FOR NEW IDEAS IN ELECTRONICS

Electronics publishers since 1908

SEPTEMBER 1976 Vol. 47 No. 9

CB RADIO	26	Equipment Report Sencore CB-41, CB Performance Tester		
	40	CB Antenna Roundup An up-to-the-minute report on what's happening in mobile CB antennas. by Herb Friedman		
BUILD ONE OF THESE	49	Mindpower: Alpha Part III —Construction details of this special mind-training machine.		
	63	555 Circuit Applications A fascinating group of circuits using this popular IC. by Robert F. Scott		
	80	Darkroom Countdown Timer Part II —Circuit board layouts and operating instructions. by George R. Baumgras		
COMPUTERS	22	Komputer Korner Substituting software for hardware		
	28	Equipment Report Vector P180 Slit-N-Wrap wiring tool		
	29	Equipment Report Texas Instruments LCM-1001 Learning Module		
	36	State of Solid State Building and using microcomputers by Karl Savon		
HIGH-FIDELITY AUDIO STEREO	57	Digital Time Delay A bucket-brigade system in use in a modern piece of hi-fi gear. by Len Feldman		
	66	R-E Lab Test Report JVC S-300 AM/FM stereo receiver		
	68	R-E Lab Test Report Empire 2000Z stereo phono cartridge		
GENERAL ELECTRONICS	4	Looking Ahead Tomorrow in electronics—today. by David Lachenbruch		
	45	Digital Clock Roundup Part II : Final section in this comprehensive report on kits. by Fred Blechman		
	74	NBS Frequency Calibration A new system from the National Bureau of Standards. by Michael S. Robbins		
	84	Test Gear For Industrial Service FETVOM's, amplified VOM's and FETMM's and their applications in industrial electronics servicing. by Jack Darr		
TELEVISION	30	Equipment Report Hickok 217 Semiconductor Analyzer		
	60	Installing TV Antennas Tips on how to select and install antennas. by James E. Kluge		
	77	Step-By-Step Troubleshooting Vertical-sweep circuits. by Jack Darr		
	88	Service Clinic The challenge: no service data. by Jack Darr		
	92	Reader Questions R-E's Service Editor solves reader problems		
DEPARTMENTS	134	Advertising Index	96	New Products
	12	Advertising Sales Offices	118	Next Month
	14	Letters	139	Reader Service Card
	6	New & Timely		

ON THE COVER
CB really explodes in Radio-Electronics this month. We've got a fast-breaking story on CB antennas for your car. It starts on page 40 and gives you a quick overlook of what's available now. And it's just the beginning of increased CB coverage that will bring you CB stories in every issue.

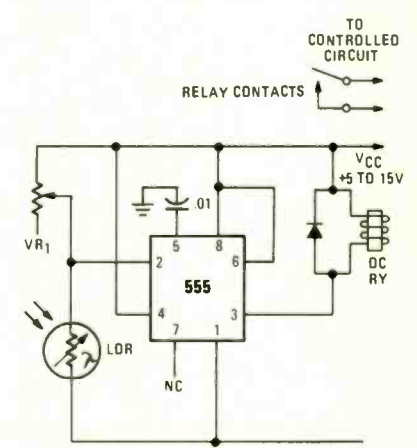

555 Circuit Applications that you'll want to try. A variety of interesting circuits that are fun to build and practical to use. The study starts on page 63.

Radio-Electronics, Published monthly by Gernsback Publications, Inc., 200 Park Avenue South, New York, NY 10003. Phone: 212-777-6400. Second-class postage paid at New York, NY and additional mailing offices. One-year subscription rate: U.S.A., U.S. possessions and Canada, \$8.75. Pan-American countries, \$10.25. Other countries, \$10.75. Single copies 75¢. © 1976 by Gernsback Publications, Inc. All rights reserved. Printed in U.S.A.

Subscription Service: Mail all subscription orders, changes, correspondence and Postmaster Notices of undelivered copies (Form 3579) to Radio-Electronics Subscription Service, Boulder, Co 80302.

A stamped self-addressed envelope must accompany all submitted manuscripts and/or artwork or photographs if their return is desired should they be rejected. We disclaim any responsibility for the loss or damage of manuscripts and/or artwork or photographs while in our possession or otherwise.

As a service to readers, Radio-Electronics publishes available plans or information relating to newsworthy products, techniques and scientific and technological developments. Because of possible variances in the quality and condition of materials and workmanship used by readers, Radio-Electronics disclaims any responsibility for the safe and proper functioning of reader-built projects based upon or from plans or information published in this magazine.

looking ahead

VTR of the month

Another home videocassette recorder is scheduled for introduction in the U.S. by the year's end. This one is from Quasar, a subsidiary of Matsushita Electric. The deck is scheduled to be priced at around \$1,000, some \$300 below competitive units offered by Sony and Sanyo. All three decks have different recording standards and so are mutually incompatible.

The Quasar VTR is a variation of *National Home Video*, now on the Japanese market at about \$700. It accommodates a cartridge that contains 1/2-inch tape which can record or play for 100 minutes, as opposed to the Sony 60-minute capacity and Sanyo's two hours. The National cassette sells for \$25 in Japan and is expected to be somewhat higher here.

Although neither of Matsushita's other two U.S. affiliates has commented on the subject, it wouldn't be surprising to see both Panasonic and JVC America marketing their own compatible versions of *National Home Video* here next year.

TV gamesmanship

The video game fad now has more than 50 entries by at least 30 companies. Many of the games are simple tennis types and most of them are awaiting the required FCC approval before going to the market. Nevertheless, game manufacturers are estimating that at least 2 million units will be sold this year, perhaps 5 million in 1977. More sophisticated microprocessor-based games are now beginning to show up. The most complex is from Fairchild—a programmable game. Special cartridges will be available containing read-only memories (ROM), each programming the unit for two to four games. In addition to the normal tennis-hockey-handball games, more sophisticated chase and target

games will be offered, as well as multiple-choice quizzes, even on-screen color "doodling".

But all may not be clear sailing for TV games. FCC Chief Engineer Ray Spence says the Commission is already beginning to receive complaints about interference caused by the games, and if the market continues to grow as fast as it has so far, it may tighten the rules on certification of games or ban all RF devices that feed into a TV set's antenna terminals. If the Commission takes the latter move, games would have to be hard-wired to the video section of the receiver—and set manufacturers would be under pressure to offer receivers with video input jacks. Such a ruling would put a crimp in plans for home VTR's and videodisc players, which also feed RF. Ray Spence also said that the FCC would wait until the end of the Christmas selling season before deciding what to do.

One new game that doesn't have the RF problem is built into a new 19-inch Magnavox color set. The new set, to retail at about \$500, contains a built-in Odyssey game that can play tennis, hockey and smash. A simple TV/game switch on the front changes the set from a TV receiver to a video game-board.

Videodisc recorder

Both Philips and RCA plan to introduce their videodisc players some time in 1977 as play-only devices. Now a professor at the University of Toronto says he's come up with a plastic disc material and low-powered laser which could make possible home recording on an optical videodisc. The laser requires only two milliwatts, just twice the power of the readout laser on the Philips player. Says inventor John Locke: "The startling reduction in laser power required for recording brings the thought of home videodisc recording, as well as playing,

into the realm of economic possibility." He estimates a videodisc recorder/player could sell for \$750 to \$800, or about 50% more than Philips' target price of \$500 for a play-back-only unit.

New Sylvania tube

Zenith and Corning Glass have been urging other picture tube manufacturers to adopt a new and unusual type of tube designed for automatic production and precision construction (R-E, June 1976). Zenith's competitors in the picture tube business admire some features of the new tube, but unanimously reject the completely new design of the glass that they say would require heavy retooling and changes in production techniques.

Now Sylvania has taken what it feels are the best features of the Zenith tube and constructed a sample using conventional glass to offer to its set-making customers. Like the Zenith tube, the Sylvania version is a narrow-neck, self-converging, in-line slot-mask type, employing a tri-potential gun for smaller spot size and with a 100-degree deflection angle. This would bring the economic advantages of self-converging slot-mask design to large-screen tubes without impairing resolution. The Sylvania tube probably won't be ready for use until late 1977. Zenith is already producing the 19-inch version of its new 100-degree tube and will crank up the 25-inch edition in the first half of 1977.

Zenith hopes to sell its new tube to other set makers as well as use it in its own TV production. But some manufacturers have complained that the new tube's slightly larger dimensions make it too big for current cabinets. To meet these objections, Zenith is considering a version with the magnetic shielding built into the inside—eliminating the necessity of having an external metal shield and just about making up for the difference in

bulk between the Zenith tube and conventional types. Zenith is digging in for a long and tough campaign to prove the superiority of its approach. Competitors, led by RCA and Sylvania, are just as determined to hang in there with the conventional tube.

More new TV's

Admiral, now a part of Rockwell International, has introduced three new TV chassis for 1977. The most interesting contains a chassis pan with no components at all—just connectors. Seven panels fit on the frame in a vertical position, five of them snapping into spring-loaded clips. The entire chassis may be assembled or disassembled in one minute. Admiral became the third American manufacturer to introduce keyboard-type digital tuning. And in its top-of-line 19- and 25-inch sets, it features consumer-installed optional remote control that can be added at the time of purchase or at any later time. To convert the set to remote control, the purchaser merely removes a one-inch square plug from the front of the set, slides in a two-inch deep receiver module and he's ready to punch in his channel number on the remote calculator keyboard.

Quasar also has new high-end chassis for 19- and 25-inch sets. This pioneer in modular television has developed an automatically produced chassis that concentrates 75% of the circuitry on a single Super-Module. IC's and the reduction in interconnections cuts the number of discrete components to 550 from 640 in last year's models and the amount of wiring to 125 from 250 feet. The Super-Module is designed for replacement by the service technician. Out of warranty, the module will cost \$100, but a factory-rebuilt unit is only \$30 on an exchange basis.

DAVID LACHENBRUCH
CONTRIBUTING EDITOR

TUNER SERVICE CORPORATION

SUBSTITUNER



JUST
\$44.95
U.S.A. ONLY
WITH CABLES

ONE YEAR
GUARANTEE

STILL ONLY



\$9.95
U.S.A. ONLY

FEATURES

- A UHF Tuner with 70 channels which are detented and indicated just like VHF channels.
- A VHF Hi Gain Solid State Tuner.
- AC Powered.
- 90 Day Warranty.

Demonstrate the **SUBSTITUNER** to your customers and show improved reception with their TV sets.

You may place your order through any of the Centers listed below.

REPAIR

PROVIDES YOU WITH A COMPLETE SERVICE FOR ALL YOUR TELEVISION TUNER REQUIREMENTS.

VHF OR UHF ANY TYPE (U.S.A. ONLY) \$ 9.95
UHF/VHF COMBINATION (U.S.A. ONLY) \$15.00

MAJOR PARTS AND SHIPPING CHARGED AT COST

- Fast, efficient service at our conveniently located Service Centers.
- All tuners are ultrasonically cleaned, repaired, realigned, and air tested.

REPLACE

UNIVERSAL REPLACEMENT TUNER \$12.95 (U.S.A. ONLY)

- This price buys you a complete new tuner built specifically by Sarkes Tarzian Inc. for this purpose.
- All shafts have a maximum length of 10½" which can be cut to 1½".
- Specify heater type parallel and series 450 mA or 600 mA.

CUSTOMIZE

- Customized tuners are available at a cost of only \$15.95. With trade-in \$13.95. (U.S.A. ONLY)
- Send in your original tuner for comparison purposes to any of the centers listed below.



WATCH US
GROW

HEADQUARTERS	BLOOMINGTON, INDIANA 47401	537 South Walnut Street	Tel. 812-334-0411
ARIZONA	TUCSON, ARIZONA 85713	1528 S. 6th Ave.	Tel. 602-791-9243
CALIFORNIA	NORTH HOLLYWOOD, CALIF. 91601	10654 Magnolia Boulevard	Tel. 213-769-2720
	BURLINGAME, CALIF. 94010	1324 Marsteg Road	Tel. 415-347-5728
	MODESTO, CALIF. 95351	123 Phoenix Avenue	Tel. 209-521-8051
FLORIDA	TAMPA, FLORIDA 33606	1505 Cypress Street	Tel. 813-253-0324
	MIAMI, FLORIDA 33150	7641 N.W. 7th Avenue	Tel. 305-754-1352
	FT. LAUDERDALE, FLORIDA 33315	1045 W. 23rd Street, Bay 16	Tel. 561-324-0914
GEORGIA	ATLANTA, GEORGIA 30310	646 Evans Street, S.W.	Tel. 404-758-2232
ILLINOIS	CHAMPAIGN, ILLINOIS 61820	405 East University Street	Tel. 217-356-6400
	DOLTON, ILLINOIS 60419	1507-09 E-142 Street	Tel. 312-841-4444
	SKOKIE, ILLINOIS 60076	3110 West Brown Street	Tel. 312-675-0230
INDIANA	INDIANAPOLIS, INDIANA 46024	112 West St. Clair Street	Tel. 317-632-3493
KENTUCKY	LOUISVILLE, KENTUCKY 40205	2244 Taylorsville Road	Tel. 502-452-1191
LOUISIANA	SHREVEPORT, LOUISIANA 71104	3025 Highland Avenue	Tel. 318-221-3027
MARYLAND	BALTIMORE, MARYLAND 21215	5505 Reisterstown Rd., Box 2624	Tel. 301-358-1186
MASSACHUSETTS	SPRINGFIELD, MASSACHUSETTS 01108	405 Dickinson Street	Tel. 413-788-8206
MISSOURI	ST. LOUIS, MISSOURI 63132	9577 Page Avenue	Tel. 314-429-0633
NEVADA	LAS VEGAS, NEVADA 89102	1312 Western Avenue, No. 1	Tel. 702-384-4235
NEW JERSEY	TRENTON, NEW JERSEY 08638	1189 Pennsylvania Avenue	Tel. 609-393-0999
	JERSEY CITY, NEW JERSEY 07307	547-49 Tonnele Ave., Hwy. 1 & 5	Tel. 201-792-3730
	ROCHESTER, NEW YORK 14615	37 Pullman Avenue	Tel. 716-647-9180
NEW YORK	GREENSBORO, NORTH CAROLINA 27401	2914 East Market Street	Tel. 919-273-6276
NORTH CAROLINA	CINCINNATI, OHIO 45216	7450 Vine Street	Tel. 513-821-5080
OHIO	CLEVELAND, OHIO 44109	4525 Pearl Road	Tel. 216-741-2314
	PORTLAND, OREGON 97210	1732 N.W. 25th Avenue, P.O. Box 7141	Tel. 503-222-9059
OREGON	PITTSBURGH, PENNSYLVANIA 15209	515 Grant Avenue	Tel. 412-821-4004
PENNSYLVANIA	MEMPHIS, TENNESSEE 38111	3158 Barron Avenue	Tel. 901-458-2355
TENNESSEE	DALLAS, TEXAS 75218	11540 Garland Road	Tel. 214-327-8413
TEXAS	NORFOLK, VIRGINIA 23513	3295 Santos Street	Tel. 804-855-2518
VIRGINIA	ST. LAURENT, QUEBEC, CALGARY, ALBERTA		
CANADA			

IF YOU WANT TO BRANCH OUT INTO THE TV TUNER REPAIR BUSINESS, WRITE TO THE BLOOMINGTON HEADQUARTERS ABOUT A FRANCHISE.

Circle 22 on reader service card

new & timely

Optical video recording system for commercial TV

The system, demonstrated by RCA for the first time at the National Association of Broadcasters convention in Chicago last March, can store up to 10,000 high-quality still pictures in full color on a 12-inch disc. It records and transmits pictures directly from and through electronic equipment already available in the studio.



DEVELOPMENTAL VIDEO RECORDING SYSTEM is capable of storing 10,000 TV pictures on a 1-inch band of the disc. The disc is about to be loaded into the system by Lee Hedlund, RCA project engineer.

Lasers focused to a very fine spot are used for recording and playback. To record, a set spots 1-micron wide and 0.5-micron long are made in a single circular track. Separation between tracks is 2.5 microns. Each track contains one picture (two fields). The disc revolves at 1800 revolutions per minute.

At present, recording is limited to 10,000 tracks, covering one inch of the disc. RCA expects to increase that number to at least 20,000.

To play back, a laser beam is focused on the desired track. The reflected light strikes a photodiode detector, converting it to an electronic video signal that is processed in the usual way.

Selection of pictures is automatic. Each picture has an identifying number that appears on the record and in a computer memory. The operator types the title of the picture into the computer, which searches the memory and finds the identifying number. It then directs the playback laser beam to the approximate position of the track. A fine-search control unit, using a small mirror in the optical path, reads the numbers of the tracks and locates the correct one.

The operator can ask the computer to display up to 400 pictures in any desired

sequence. Or, the pictures can be preprogrammed in groups and the operator need type in only the title of the group to have the slides presented in proper sequence.

The equipment demonstrated covered only still pictures, but the technology can also record motion. RCA believes that "It is conceivable that some years in the future a TV station might broadcast an entire day's program from disc recordings."

Newest digital wristwatch will also carry a message

A new five-function digital electronic watch module introduced by Hughes will carry a pre-programmed message of up to four five-letter words, in addition to the usual readout of month, date, hour, minute and second. The fixed message is programmed onto the MOS chip that controls the watch readout in a separate masking stage during manufacture. Five 9-segment LED's provide an alphanumeric readout of up to five letters per word. The words are read out sequentially.

Fixed phrases to be offered include common messages of greeting, affection, etc., expected to be in demand (see photo). In addition, custom modules with special commercial, advertising, or political slogans will be offered to businesses. For orders of 1,000 or more, no extra charge will be levied for the special phrase. For smaller orders, a masking charge will be added to the price of the module.

Although Hughes Aircraft Company's solid-state division does not market a watch to consumers under its own name, it is the leading supplier of the solid-state

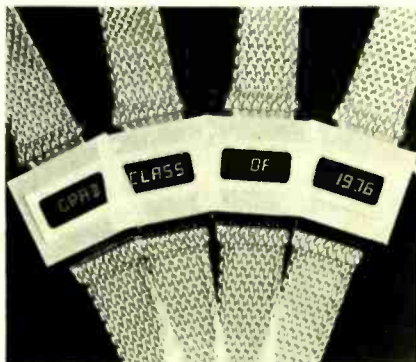

NEWEST ELECTRONIC DIGITAL WATCH carries a greeting or message in addition to reading out time and date. Four words of five or fewer letters are spelled out sequentially.

modules to name-brand and private-label watch companies.

Add another 44,600 miles to your next long-distance call!

Latest of the communications satellites to go into orbit, Comstar, was launched May 6. In synchronous orbit 22,300 miles above the earth, it is the first of four satellites in a domestic communications system built for Comsat General Corporation by Hughes Aircraft Co. at a total cost of \$65.9 million. The system will consist of two primary satellites and a third to serve as backup. The fourth will be held on the ground as a spare. The satellites are expected to have a life of seven years.

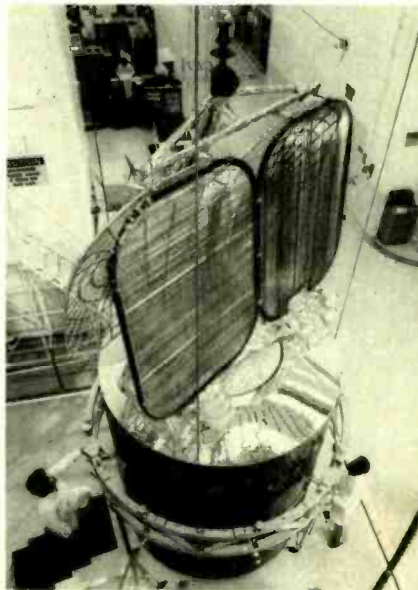

COMSTAR SATELLITE, shown in final checking stage at Hughes Aircraft, will be used by AT&T and GTE Satellite Corp. to supply telephone service to all 50 states and Puerto Rico. The rectangular reflectors provide a technique for using the same frequency twice.

The system is designed to enable transmissions to and from all 50 states and Puerto Rico. It will be used jointly by AT&T (American Telephone & Telegraph Corp.) and GTE General Corp. The satellites will work from and to seven earth stations, four owned by AT&T and three by GTE Satellite Corp. Cost of the ground stations is about \$77 million.

Dominant feature of the Comstar satellite is a pair of rectangular reflectors with filter screens for horizontal and vertical polarization of the microwave signals. Such polarization permits using the same frequency twice, thus doubling the effective capacity of the transmitting system while conserving the frequency spectrum.

continued on page 12

VACO.



Super Kits

Vaco means value and variety.

Like our Super Kits. Available in three models. The 99500 Kit offers 20 top quality tools: pliers, cutters, wrenches, screwdrivers, nutdrivers and more. The 99000 has 13 screwdrivers and nutdrivers—all interchangeable! And the 99900 is a complete hex key service kit for assembly, production or service work. All come in handy roll-up pouches and all are professional quality—unconditionally guaranteed.

You'll find these and all the other fine Vaco tools in our exciting new 64-page Bicentennial Catalog! FREE for the asking. Just write:

Vaco Products Co., 510 N. Dearborn St., Chicago, Illinois 60610.

Send for your **FREE**



64 colorful pages with the complete Vaco selection.

1976 VACO catalog!

Circle 32 on reader service card

Learn to service Communications / CB equipment at home...with **NRI'S COMPLETE COMMUNICATIONS COURSE**

Learn design, installation and maintenance of commercial, amateur, or CB communications equipment.

The field of communications is bursting out all over. In Citizens Band alone, class D licenses grew from 1 to over 2.6 million in 1975, and the FCC projects about 15 million CB'ers in the U.S. by 1979. That means a lot of service and maintenance jobs . . . and NRI can train you at home to fill one of those openings. NRI's Complete Communications Course covers all types of two-way radio equipment (including CB), AM and FM



Transmission and Reception, Television Broadcasting, Microwave Systems, Radar Principles, Marine Electronics, Mobile Communications, and Aircraft Electronics.

The course will also qualify you for a First Class Radio Telephone Commercial FCC License or you get your tuition back.

Learn on your own 400-channel digitally-synthesized VHF transceiver.

You will learn to service all types of communication equipment, with the one unit that is designed mechanically and electronically to train you for CB, Commercial and Amateur communications: a digitally-synthesized 400-channel VHF transceiver and AC power supply. This 2-meter unit gives you "Power-On" training. Then we help you get your FCC Amateur License with



special instruction so you can go on the air.

The complete course includes 48 lessons, 9 special reference texts, and 10 training kits. Included are: your own electronics Discovery Lab, Antenna Applications Lab, CMOS Frequency Counter, and an Optical Transmission System. You'll learn at home, progressing at your own speed, to your FCC license and into the communications field of your choice.

NEW CB SPECIALIST COURSE NOW OFFERED



NRI now offers a special course in CB Servicing. You get 37 lessons, 8 reference texts, your own CB Transceiver, AC power supply and multi-meter . . . for hands-on training. Also included are 14 coaching units to make it easy to get your commercial radio telephone FCC license—enabling you to test, install, and service communications equipment.

NRI offers you five TV/Audio Servicing Courses

NRI can train you at home to service TV equipment and audio systems. You can



choose from 5 courses, starting with a 48-lesson basic course, up to a Master Color TV/Audio Course, complete with designed-for-learning 25" diagonal

solid state color TV and a 4-speaker SQ™ Quadraphonic Audio System. NRI gives you both TV and Audio servicing for hundreds of dollars less than the two courses as offered by another home study school.

All courses are available with low down payment and convenient monthly payments. All courses provide professional tools and "Power-On" equipment along with NRI kits engineered for training. With the Master Course, for instance, you build your own 5" wide-band triggered sweep solid state oscilloscope, digital color TV pattern generator, CMOS digital frequency counter, and NRI electronics Discovery Lab.



™Trademark of CBS Inc.

NRI's complete computer electronics course gives you real digital training.

Digital electronics is the career area of the future . . . and the best way to learn is with NRI's Complete Computer Electronics Course. NRI's programmable digital computer goes far beyond any "logic trainer" in preparing you to become a computer or digital technician. With the IC's in its new Memory Kit, you get the only home training in machine language programming . . . experience essential to trouble shooting digital computers. And the NRI programmable computer is just one of ten kits you receive, including a TVOM and NRI's exclusive electronics lab. It's the quickest and best way to learn digital logic and computer operation.

You pay less for NRI training and you get more for your money.

NRI employs no salesmen, pays no commissions. We pass the savings on to you in reduced tuitions and extras in the way of professional equipment, testing instruments, etc. You can pay more, but you can't get better training.

More than one million students have enrolled with NRI in 62 years.

Mail the insert card and discover for yourself why NRI is the recognized leader in home training. No



salesman will call. Do it today and get started on that new career.

APPROVED UNDER GI BILL

if taken for career purposes Check box on card for details.



NRI SCHOOLS
McGraw-Hill Continuing Education Center
3939 Wisconsin Avenue,
Washington, D.C. 20016

Hugo Gernsback (1884-1967) founder
M. Harvey Gernsback
editor-in-chief and publisher
Larry Steckler, CET, editor
Robert F. Scott, W2PWG, CET,
technical editor
Arthur Kleiman, associate editor
Jack Darr, CET service editor
Leonard Feldman
contributing high-fidelity editor
David Lachenbruch, contributing editor
Karl Savon, semiconductor editor
Vincent P. Cienia, production manager
Harriet I. Matysko, circulation director
Sheila Wertling, circulation assistant
Arline R. Bailey, advertising coordinator

Cover design by Louis G. Rubsamen
Cover photo by Walter Herstatt

Radio Electronics is a member of the Institute of High Fidelity and is indexed in Applied Science & Technology Index and Readers Guide to Periodical Literature.



Radio-Electronics magazine is published by Gernsback Publications, Inc.
200 Park Ave. S., New York, NY 10003
(212) 777-6400

President: M. Harvey Gernsback
Vice President: Larry Steckler
Treasurer: Carol A. Gernsback
Secretary: Bertina Baer

ADVERTISING SALES

EAST

Stanley Levitan, Sales Manager
Radio-Electronics
200 Park Ave. South
New York, NY 10003
(212) 777-6400

MIDWEST/Texas/Arkansas/Okla.

Ralph Bergen
Jim Reilly
The Ralph Bergen Co.
6319 N. Central Ave.
Chicago, IL 60646
(312) 792-3646

PACIFIC COAST Mountain States

Jay Eisenberg
J.E. Publishers Representative Co.,
8732 Sunset Blvd.,
4th Floor,
Los Angeles, CA 90069
(213) 659-3810
Sales Mart Building
1485 Bayshore Blvd., Box 140
San Francisco, CA 94124
(415) 467-0125

SOUTHEAST

J.E. Publishers Representative Co.,
214-387-2424

Audio via infrared helps hard-of-hearing children

Infrared transmission has been used by the entertainment industry to power remote loudspeakers in multiple-speaker systems. It is now being used by Siemens in a new type of speech-hearing training equipment for hard-of-hearing children.

In a new two-channel system now being tested, the audio signals are modulated on two separate carrier frequencies of 200 and 280 kHz. The transmitter is contained in the instructor's desk, from where the energy is transmitted by cable to four radiators in the corners of the room. These contain 12 infrared transmission diodes each. The energy is great enough to "illuminate" classrooms 30 feet square or larger. Transmitting power is 10 watts. Only about 5 percent of this, or 500 milliwatts, is delivered as optical output.

The children wear headphones and carry a receiving set that picks up the optical signals at any point in the room. Depending on the child's hearing deficiency, the right and left channels can be set individually. By throwing a switch, the receiver becomes a high-quality stereo hearing aid with which the children can communicate with each other in the classroom or schoolyard. The large frequency spacing of 80 kHz between channels allows high reproduction quality from 50 to 15,000 Hz.

The great advantage of this technique over magnetic induction wireless or other systems is that the infrared radiation is absorbed by walls and doors, and thus



NEW INFRARED TRANSMISSION SYSTEM for teaching hard-of-hearing children uses receivers almost identical in appearance to the ones used in older induction systems. The difference is that none of the infrared energy gets out of the room, making it possible to use similar systems in all the rooms of a large school.

does not extend beyond the room in which the transmitter is situated. This makes it possible to use it in all the rooms of a large school, absolutely without inter-

ference. Each room has its own transmitter; the students carry their receivers from room to room throughout the building and can use them practically from primary school to matriculation.

Lasers could revolutionize internal combustion engines

A laser engine similar to an ordinary internal combustion engine (which could in fact be made from a piston-type gas engine by a few modifications) can operate at twice the efficiency of today's engines. This new engine was described in the May, 1976, issue of *Applied Optics* by Drs. Max Garbuny and Martin Pecher-sky of Westinghouse Research Laboratories. While the article describes techniques that are largely far in the future, practical work is being done on the project under a NASA-Ames contract, and at least one low-power laser engine has been tested.

The "fuel" in this system would be a simple laser beam, while the cylinders would contain a recyclable gas that is heated by the laser beam to expand and drive the pistons. The exhausted gas is discharged into a heat exchanger (what steam-engine people would call a "condenser") to cool, then returned via the intake valve to be used over again.

Most important modification of present engines is a window that is transparent to infrared light, to permit the laser beam to be focused in the cylinder. The gas would be a type similar to helium, to which a small quantity of gas that absorbs the laser discharge is added. An example would be carbon monoxide (CO) gas, working with a carbon monoxide laser. (Most of the experimental work to date has been with a CO₂ (carbon dioxide) laser and CO₂ gas.)

A laser beam focused through the window to a point near the center of the gas in the cylinder will excite the absorbing gas, raising temperature of the gas mixture at the focal point to nearly 10,000° C. This will cause the gas to expand more rapidly than is possible in a conventional internal combustion engine. Since the highest temperature would be at the center of the gas column in the cylinder and would drop off rapidly from that point, temperatures at the cylinder walls and piston face are in a range the metal could tolerate.

An interesting possibility arises from the fact that the beam-producing apparatus need not be connected to the rest of the equipment—the engine could be remotely powered. The only limiting factors are the necessity of directing the beam accurately through the cylinder window, and the absorption of the air through which the beam passes.

An Extraordinary Offer to introduce you to the benefits of Membership in

ELECTRONICS BOOK CLUB

take any 3 of these unique electronics books—value to \$58.70 ...for only 99¢ each

with a Trial Membership in the Book Club that guarantees to save you 25% to 75% on a wide selection of electronics books



101-ELECTRONIC CIRCUIT DESIGN HANDBOOK. GIANT 416-p. circuit-designer's cookbook with 639 designs. 8 1/2 x 11". 416p. 966i. List \$17.95
 487-544-p. TRIPLE SELECTION: 64 Hobby Projects for Home & Car. A host of unique, fun-to-build gadgets bound to please everybody! 192p. 159i. List \$7.95
 582-NEW IC FET Principles & Projects. Learn about today's FETs by building useful projects from simple devices to sophisticated logic circuits. 160p. 70i. List \$6.95
 676-PRACTICAL TRAC/SCR PROJECTS. Balanced blend of thyristor theory and practical circuits. 192p. 146i. List \$7.95
 510-512-p. DOUBLE SELECTION: How to Read Electronic Circuit Diagrams. Anyone can quickly learn his way around circuits and trace signals. 256p. 140i. List \$8.95
 672-BASIC Electricity & Beginning Electronics. Enjoyable text that combines electron theory with high reader interest. 256p. 191i. List \$8.95
 563-328-p. DOUBLE SELECTION: Beginner's Guide To TV Repair. Ideal handbook for anyone who wants to learn the basics of TV repair. 160p. 80i. List \$7.95
 563-INSTALLING TV & FM ANTENNAS. How to get clean, interference-free signals to your receiver...in all locations. 168p. 156i. List \$7.95
 582-COMMERCIAL FCC LICENSE HANDBOOK. Everything you need to know to pass the 1st, 2nd, 3rd class exams is included. 444p. 150i. List \$9.95
 586-368-p. DOUBLE SELECTION: Fascinating World of Radio Communications. Covers the romance of listening to all the bands. 176p. 56i. List \$6.95
 586-UNDERSTANDING & USING Radio Communications Receivers. Semitechnical approach to help upgrade performance. 192p. 75i. List \$7.95
 640-476-p. DOUBLE SELECTION: Selecting & Improving Your Hi-Fi System. Tells you what to look for, to expect, and to avoid. 224p. 122i. List \$7.95
 640-CHANNEL Stereo. From Source to Sound. ALL the simplified theory and how it's done...into. Shows how you can get started with a couple of speakers and a matrix that costs less than a dollar! 252p. 102i. List \$7.95
 672-MINIATURE PROJECTS for ELECTRONIC HOBBYISTS. 20 practical, useful projects using miniature solid-state components. 168p. 77i. List \$6.95
 701-ELECTRICAL WIRING & LIGHTING FOR HOME & OFFICE. Do complete home or office wiring jobs, incl. illumination systems. 204p. 155i. List \$7.95
 672-UNDERSTANDING & USING the VOM & EVM. Modern guide to every possible application of the VOM. 192p. 187i. List \$7.95
 676-SIMPLIFIED COMPUTER PROGRAMMING. Really makes programming simple. Stresses RPG system. 240p. 177i. List \$8.95
 681-QUESTIONS & ANSWERS ABOUT TAPE RECORDING. Has ALL the answers, plus ALL the circuits, sketches, and wiring diagrams you'll ever need! Covers just about any problem you might encounter. 264p. 102i. List \$8.95
 683-PICTORIAL GUIDE TO CB RADIO INSTALLATION & REPAIR. Step-by-step approach to installing CB and ham gear in home or car. How to reduce interference, tune the antenna, maintain equipment, etc. 256p. 300i. List \$8.95
 701-CET LICENSE HANDBOOK. Covers all you need to pass the exam, including new audio & industrial exams. Includes replica test. 272p. 289i. List \$8.95
 722-AMATEUR FM CONVERSION & CONSTRUCTION PROJECTS. Covers it all, from the simple to the complex. 276p. 187i. List \$8.95
 715-408-p. DOUBLE SELECTION: Small Appliance Repair Guide. Shows how easy appliances are to repair if you know how they work, come apart, and go back. 210p. 119i. List \$7.95
 732-Home Appliance Clinic. Meatsytreasure of hard-to-come-by info on wiring & appliance repair. 196p. 61i. List \$7.95
 732-JAP CONSUMER ELECTRONICS SCHEMATIC/SERVICING MANUAL. Gold mine of 89 hard-to-find schematics, plus all the service data needed for radios, tape players, phonos, etc. 8 1/2 x 11". 196p. 240i. List \$8.95
 812-RADIO CONTROL FOR MODELS. Most complete RC handbook ever. Covers literally everything—planes, boats, cars, helicopters, tanks, etc. 350p. 417i. List \$9.95
 821-TV TROUBLESHOOTER'S HANDBOOK. GIANT quick-reference fingertip sourcebook for 100's of tried-and-tested solutions to "tough-dog" TV troubles. Thumb-indexed. Covers Admiral to Zenith. 448p. 300i. List \$9.95
 300-BONUS BOOK IF YOU RENT NOW! Dictionary of Electronics. Handy reference for all in electronics. Defines 1000's of terms. 420p. 487i. List \$4.95
 TYPICAL CLUB SELECTIONS and List/Club prices: Master Handbook of 1001 Practical Electronic Circuits \$12.95/\$7.95—Microprocessor/Microprogramming Handbook \$9.95/\$5.95—OP AMP Circuit Design & Applications \$9.95/\$5.95—Electronic Music Circuit Guidebook \$9.95/\$5.95—Build Your Own Working Robot \$8.95/\$5.95—Introduction to Medical Electronics \$9.95/\$6.95—CB Radio Operators' Guide \$8.95/\$5.95—Microelectronics \$8.95/\$5.95—21 Simple Transistor Radios You Can Build \$6.95/\$3.95—Ham Radio Advanced Class License Study Guide \$8.95/\$4.95—Small-Screen TV Servicing Manual \$9.95/\$5.95—Aviation Electronics Handbook \$11.95/\$7.95—Practical CB Radio Troubleshooting Repair \$8.95/\$5.95—Advanced Applications For Pocket Calculators \$8.95/\$5.95—Handbook of Multichannel Recording \$10.95/\$7.95—Radio Astronomy for the Amateur \$8.95/\$5.95

May we send you your choice of three of the practical, time-and-money-saving books on these pages as part of an unusual offer of a Trial Membership in Electronics Book Club?

Here are quality hardbound volumes, each especially designed to help you increase your know-how, earning power, and enjoyment of electronics.

These handsome, hardbound books are indicative of the many other fine offerings made to Members...important books to read and keep...volumes with your specialized interest in mind.

Whatever your interest in electronics—radio and TV servicing, audio and hi-fi, industrial electronics, communications, broadcasting, electronics as a hobby—you will find Electronics Book Club will help you get the job you want, keep it, improve it or make your leisure hours more enjoyable. With the Club providing you with top quality books, you may broaden your knowledge and skills to build your income and increase your enjoyment of electronics too.

This Special Offer is just a sample of the help and generous savings the Club offers you. For here is a

Club devoted exclusively to seeking out only those titles of direct interest to you. Members are annually offered over 50 authoritative books on all phases of electronics.

This extraordinary offer is intended to prove to you, through your own experience, that these very real advantages can be yours...that it is possible to keep up with the literature published in your areas of interest...and to save substantially while so doing. As part of your Trial Membership, you need purchase as few as four books during the coming 12 months. You would probably buy at least this many anyway...without the savings offered through Club Membership.

To start your Membership on these attractive terms, simply fill out and mail the coupon today. You will receive the books of your choice for 10-day inspection. YOU NEED SEND NO MONEY! If you are not delighted, return them within 10 days and your Trial Membership will be cancelled without cost or obligation.

ELECTRONICS BOOK CLUB P.O. Box 10, Blue Ridge Summit, Pa. 17214

Facts About Club Membership

- The 3 introductory books of your choice carry publishers' retail prices of up to \$58.70. They are yours for only 99¢ each (plus postage and handling) with your Trial Membership.
- EXTRA BONUS! If you act now and send remittance with Membership Application, we will pay all shipping and handling on your introductory books, and you will also receive the \$4.95 paperback book, "Dictionary of Electronics," giving you a total value of up to \$63.65.
- You will receive the Club News describing the current Selection, Alternates and other offerings, every 4 weeks (13 times a year).
- If you want the Selection, do nothing; it will be sent to you automatically. If you do not wish to receive the Selection, or if you want to order one of the many Alternates offered, you simply give instructions on the reply form (and in the envelope) provided, and return it to us by the date specified. This date allows you at least 10 days in which to return the form. If, because of late mail delivery, you do not have 10 days to make a decision and so receive an unwanted Selection, you may return it at Club expense.
- Personal service for your account—no computers used!
- To complete your Trial Membership, you need buy only four additional monthly selections or alternates during the next 12 months. You may cancel your Membership any time after you purchase these four books.
- All books—including the Introductory Offer—are fully returnable after 10 days if you're not completely satisfied.
- All books are offered at low Member prices plus a small postage and handling charge. Prepaid orders shipped postpaid.
- Continuing Bonus: If you continue after the Trial Membership, you will earn a Dividend Certificate for every book you purchase. Three Certificates, plus payment of the nominal sum of \$1.99, will entitle you to a valuable Book Dividend of your choice which you may choose from a list provided Members.

ELECTRONICS BOOK CLUB

P.O. Box 10
Blue Ridge Summit, Pa., 17214

Please send the 3 books circled below and invoice me.
 My remittance is enclosed. Send me the 3 books circled plus "Dictionary of Electronics."

Please open my Trial Membership in ELECTRONICS BOOK CLUB as I have indicated above. I understand the cost of the books I have selected is only 99¢ each, plus a small shipping charge. If not delighted, I may return the books within 10 days and owe nothing, and have my Trial Membership cancelled. I agree to purchase at least four additional books during the next 12 months, after which I may cancel my membership at any time.

101	487	510	563	582	586
640	667	671	672	676	681
701	715	722	732	812	821

Name _____ Phone _____

Address _____

City _____

State _____ Zip _____

(Foreign and Canada add 10%) RE-96

Circle 24 on reader service card

Letters

COMPUTER CLUB

A number of my associates in the computer industry and I are forming a Rhode Island computer hobbyist club. Several members are already building their own systems, including two Altairs and two micros based on the MCS-6502, and an assembler is being written in Fortran to assemble MCS-6502 machine language programs.

If any of your readers are interested in either joining our club or in exchanging programs and experience with the MCS-6502 they may contact me at the following address:

Rhode Island Computer Hobbyist Club
16 Grinnell Street
Jamestown, RI 02835

ROGER C. GARRETT
Jamestown, RI

TI MEMORY

I own a Texas Instruments SR-51 calculator, and I must rebut the claims made by Thomas S. Cox in the July "Letters" column regarding hidden memory

capabilities in TI calculators.

It is true that if you press STO X, you can press RCL X and recall that data, but reader Cox failed to realize that the same data is also entered in two or three other registers. For example, if you store data in "memory 6" by pressing STO 6, you'll find that you can recall that data by pressing RCL 3, RCL 4, RCL 5, or RCL 6. Obviously, this is no good!

The table below shows the memory arrangement of the SR-51:

	RCL									
	1	2	3	4	5	6	7	8	9	0
STO 1	x						x		x	
2		x						x		x
3			x	x	x	x				
4			x	x	x	x				
5			x	x	x	x				
6			x	x	x	x				
7	x						x		x	
8		x						x		x
9	x						x		x	
0		x						x		x

Alas, TI did not let their "super"

calculators get out of the shop with any greater memory capacity than advertised.

ERIC G. LEMMON
Vandenberg AFB, CA

VASCAR WARNING

In the June issue, the "New Products" section features a device called a Senturion, and says: "It detects and gives early warning of all modern traffic control radar systems, including the "Speed Gun" and VASCAR moving radar systems." This is flatly untrue, and your readers should be so advised.

The VASCAR system is not a radar device. It is a passive system and does not emit any signal to be detected. In operation, the operator enters the distance between any two points, either manually or by driving between them in his patrol car. He then activates the device when a suspect car passes (that is, is seen to pass) one of the points, and again when the suspect car is seen to pass the other point. The VASCAR device reads out the

continued on page 16

Semiconductors made very, very easy.

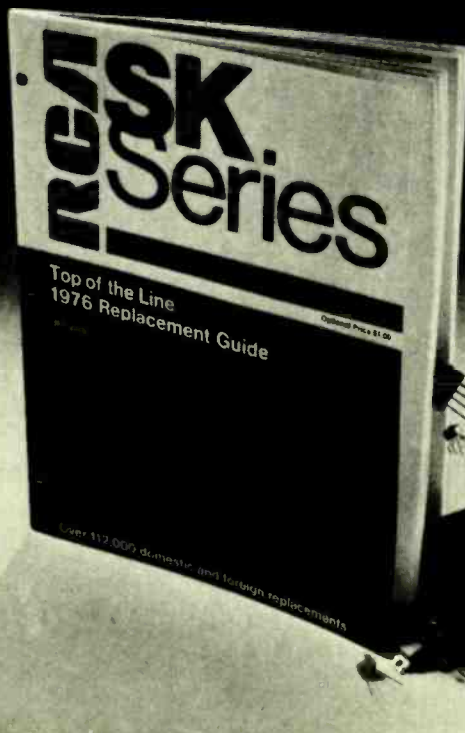

How to stock 300 instead of 112,000. All it takes is RCA's "Top of the Line" SK Series 1976 Replacement Guide. Our most comprehensive list to date of transistors, rectifiers, thyristors and integrated circuits — 300 RCA types to replace 112,000 in entertainment or industrial equipment.

Excellent Product. Excellent Catalog. As a product, RCA SK replacement semiconductors measure up to strict AQL standards. As a catalog, our 1976 Replacement Guide is a thorough, accurate informational source, representing thousands of engineering man-hours.

Get the "top of the line" now. With RCA's SK Series and RCA's SK Replacement Guide. Contact your RCA Distributor. Or send \$1.00 (check or money order) to RCA Distributor and Special Products Division, P.O. Box 85, Runnemede, N.J. 08078.

RCA SK Replacement Semiconductors

Circle 59 on reader service card

Get total performance from your transceiver with a Royce antenna!

Total performance is what Royce offers you. And, who would know better than we how vital it is to match transceiver quality and antenna quality?

We have a lot at stake. As our reputation as innovators in personal communications grows, we simply cannot afford to put the Royce name on any antenna that does not meet the highest standards.

That is why Royce settles for nothing less than highest quality cables...precision coil winding...the use of brass on nearly every fitting and piece of hardware...chrome plating over brass...stainless steel whips.

We make sure your Royce antenna gets to you factory-fresh, too. It's blister packed, and shipped in an individual corrugated carton.

In that carton you will find complete installation instructions in a



comprehensive booklet that tells you why proper antenna installation is so important.

Go all the way, and get *total* performance by matching the quality of your CB with the quality of a Royce antenna!

We offer the complete line—bumper mount, body mount, rooftop or deck models, trunk lip, magnet mount, gutter mount, or California mirror mount. Stainless steel or fiberglass.

Write for complete details.

Follow the new leader!

Royce



Royce Electronics Corporation
1746 Levee Road
North Kansas City, Mo. 64116
Call: (816) 842-7505 • Telex: 426-145

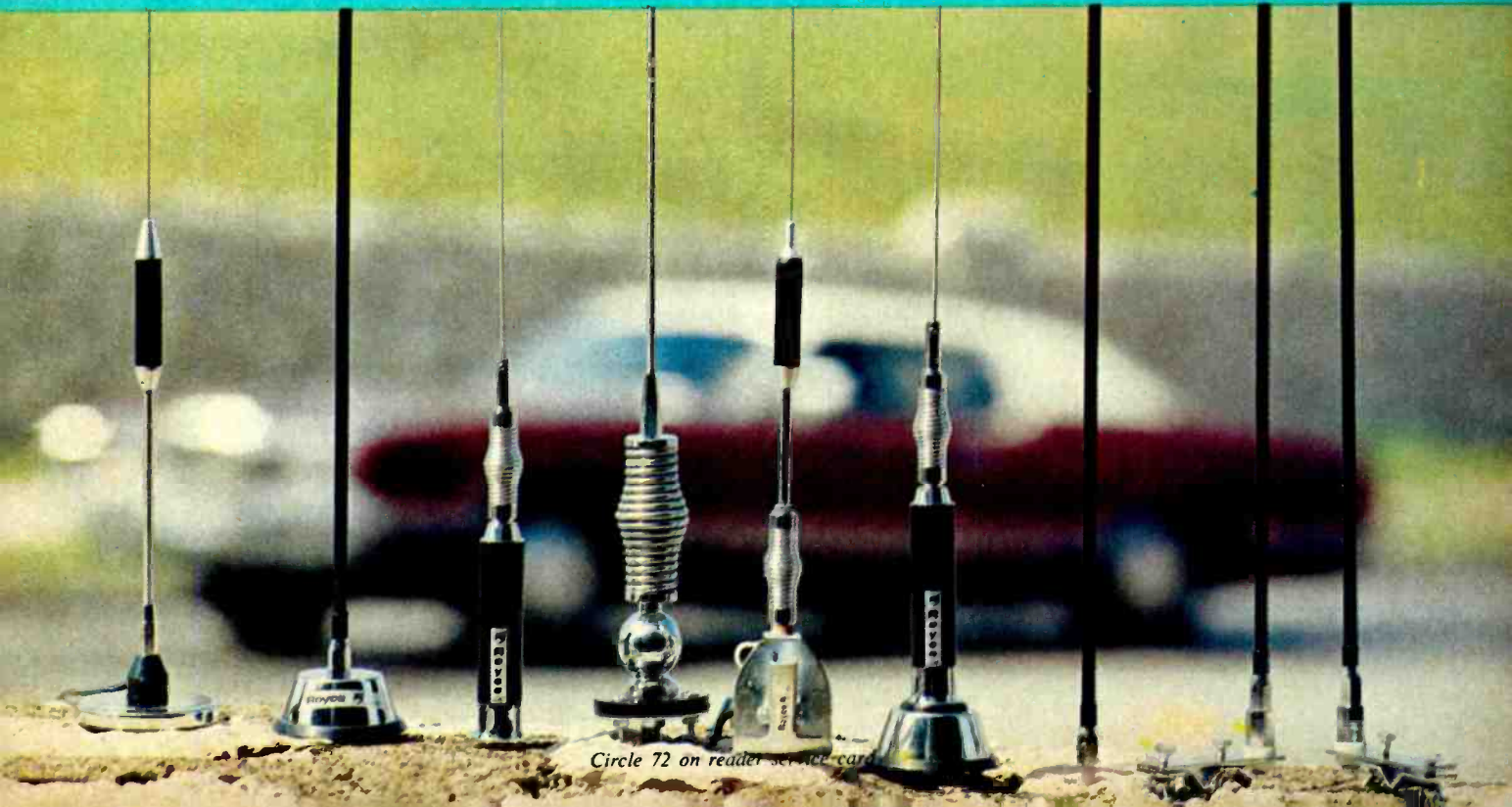

Circle 72 on reader service card

LETTERS

continued from page 14

average speed of the suspect car by a simple distance/time comparison.

If the false claim was made by the manufacturer, they would appear to be guilty of false advertising. In any event, one false claim tends to diminish the credibility of the others. Please advise your readers that neither Senturion, nor any other radar detector, will provide warning of a VASCAR device.

ROY B. SCHERER
Richmond, VA

1984?

I wrote you a letter a couple of years ago congratulating you upon your no-

pussyfooting-around publication of construction projects for direct connection to telephone lines. We are all glad to see that your position is gradually being vindicated by the highest courts in the land. I congratulate you also on your boldness in going ahead with publication of direct-connection video construction projects, and I am confident that you will be vindicated in this also by relaxing or removal of present excessively restrictive regulations.

However, I was only recently made aware of an interesting by-product of such activities. The occasion resulted from my having subscribed to the magazine *Teletronics* (which had been advertised in the classified section of *Radio-Electronics*), the purpose of which was to reveal all the mysteries of how Ma Bell operated. I really

did not have a very clear idea of what I was subscribing to, but as the issues finally did start arriving I was mildly interested and often amused at the material they carried, particularly by what I thought was their paranoid conviction that the Phone Co. was after them.

Two weeks ago I received this nasty threatening letter from the "Security Office" of the Pacific Telephone and Telegraph Company, and it appears that not only did PT&T succeed in putting *Teletronics* out of business, but that they were actually able to confiscate their mailing lists. Now it is I who am feeling paranoid—I'll bet PT&T sends copies of that subscriber list to every regional telephone company in America!

I am enclosing a copy of the PT&T missive. It would appear to me to be saying that dissemination or mere possession of information which **COULD BE USED** for disapproved purposes is a criminal offense—hence their urging that copies of *Teletronics* magazine be destroyed. I am committed to the position that **CURIOSITY ALONE** is sufficient "need to know," and that it is a fundamental freedom that criminality must be judged by what an individual **DOES**, not upon the knowledge which he has acquired or what he **COULD** do with it.

CHARLES D. GEILKER
Assoc. Prof. of Physics
William Jewell College
Liberty, MO

Dear Telephone User:

On March 25, 1976, the Superior Court of California, County of Los Angeles, entered an injunction in favor of The Pacific Telephone and Telegraph Company and against *Teletronics* Company of America, and others. Your name appeared on a list (provided under Court order) of subscribers, or potential subscribers, to material previously published and distributed by *Teletronics* Company of America. Accordingly, for your protection and benefit, you are hereby given the following notice:

IT IS A VIOLATION OF STATE AND FEDERAL LAW TO USE ANY INSTRUMENT, DEVICE OR SCHEME TO OBTAIN ANY TELEPHONE SERVICE WITHOUT PAYMENT OF THE LAWFUL CHARGES THEREFOR. IT IS ALSO A CRIME TO PROVIDE INFORMATION TO ANY PERSON WHICH IS USEFUL FOR SUCH PURPOSE. IN MANY STATES, THE POSSESSION OF OR DISSEMINATION OF PLANS OR INSTRUCTIONS FOR SUCH DEVICES IS A CRIMINAL OFFENSE.

VIOLATIONS OF THESE LAWS ARE VIGOROUSLY INVESTIGATED AND PROSECUTED. ACCORDINGLY, YOU ARE URGED TO DESTROY ANY AND ALL WRITTEN MATERIAL OR DEVICE YOU MAY HAVE WHICH MAY VIOLATE ANY OF THESE LAWS.

THIS STATEMENT IS BEING SENT TO YOU BY ORDER OF THE SUPERIOR COURT OF CALIFORNIA, COUNTY OF LOS ANGELES.

The Pacific Telephone and Telegraph Company

I'm in a state of shock. For the first time in my life I don't know what to say, except to ask: Is 1984 8-years away?—Editor

Could the ultimate system be all Crown?



It depends on how you define "ultimate." But Crown may be the only top-quality, state-of-the-art manufacturer whose components could build a complete, ultimate hi-fi system.

For instance: A CX-824 tape deck, world-renowned for reliable performance. Connected to an IC-150A pre-amp. With the signal amplified by a DC-300A power amp, proved in many thousands of hours of professional use. Output controlled, monitored and switched by an OC-150A. Possibly a VFX-2 for personal control of crossover points. And sound faithfully reproduced by ES-212 electrostatic speakers.

All Crown. We think that system would be somebody's ultimate. Certainly ours. Maybe yours.

Your own system, ultimate or not, might include one of the Crown product alternatives. The D-150A and D-60 amps offer the same low distortion as the DC-300A, with less power. All Crown recorders have the same quality sound, but you select the transport, electronics, accessories, heads or tracks you need.

For fast information, fill out the coupon below and send it directly to Crown. Or circle the number below. Or visit your Crown dealer, ultimately.

Fast playback coupon

Send me information on amplifiers
 recorders control centers everything

When listening becomes an art,

Name _____

Address _____

City _____

State _____ Zip _____



CROWN

Box 1000, Elkhart IN 46514

RE6

Circle 43 on reader service card

A Replacement is an Improvement with Amperex RF Communications Components

RF Power Tubes,
RF Power Transistors,
Small Transmitting Tubes,
Microwave Triodes,
Silicon Rectifier Stacks,
Vacuum Capacitors,
Industrial Receiving Tubes.

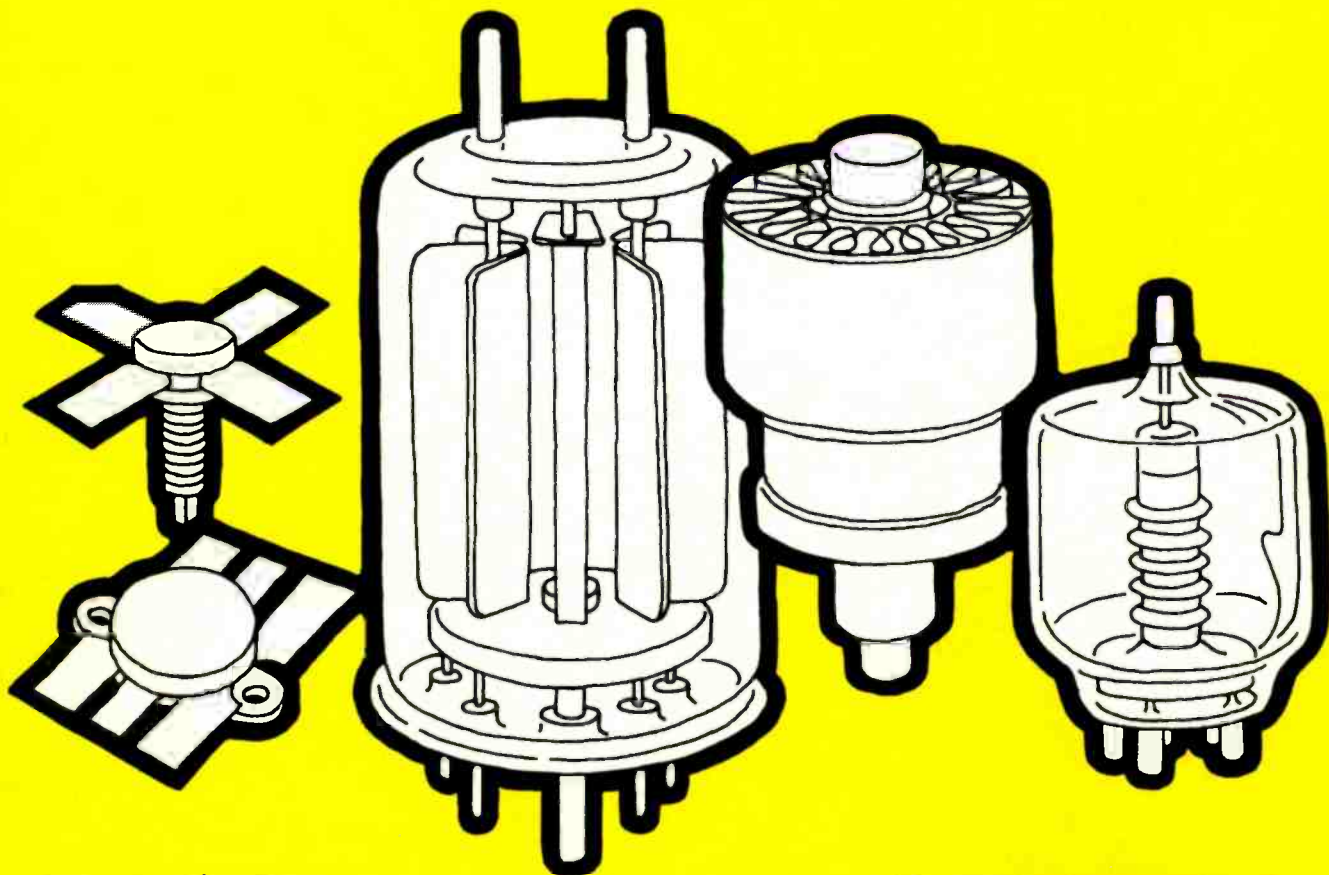

For complete information on
Amperex Replacement Tubes
and Components for:

- **RF Communications Transmitters**
- **Radio & TV Broadcast Equipment**
- **Industrial Power Supplies & Oscillators**
- **Microwave Ovens & Commercial Radar Equipment**
- **Scientific Instruments...**

contact Bob Norris, Distributor Sales Operation.
Amperex Electronic Corporation, Hicksville, New York 11802.
Telephone: 516-931-6210.

Amperex®

TOMORROW'S THINKING IN TODAY'S PRODUCTS

A NORTH AMERICAN PHILIPS COMPANY

THE NEW HEATHKIT CATALOG

FREE

Send for yours TODAY!



NEW! SSB/CW Receiver covers 80-10 meter Amateur radio bands. Excellent sensitivity and selectivity, all solid-state, built in AC power supply with input for external battery operation. LSB, USB and CW operation. The HR-1680 is an outstanding addition to ANY station, for only **\$199⁹⁵**



NEW! A CRT Tester/Rejuvenator that really works! Whether you're a TV service professional, or a hobbyist working on your own sets, the IT-5230 can really do the job! Tests, cleans and rejuvenates virtually all CRT's, color or black and white, including the new IN-LINE GUN types. Performs as well as units costing much more, for only **\$89⁹⁵**



NEW! Tri-Output Power Supply. Perfect for experiments, design and service! The IP-2718 has fixed 5-volt and two variable 0-20 volt VDC outputs that can be connected in any combination; and the two 20-volt outputs can be tracked. Full-featured, with front panel meter, rugged bench-type case, universal binding posts. Real power supply versatility for only **\$79⁹⁵**

Over 400 fun-to-build, money-saving electronic kits!

Every Heathkit
combines kit econo
easy "buildabi...

top performance. So you get real va
and fine equipment, plus do-it-yourself
pride and satisfaction. See what you can
build better — order your FREE catalog today!

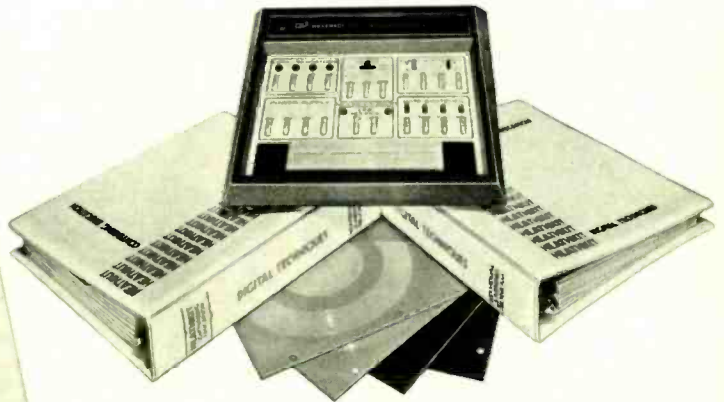

Digital Electronics Individual Learning Program.
A self-learning program for anyone who is into digital techniques. Digital fundamentals, circuit design, microprocessor theory, lots more, brought to you in easy, efficient programmed learning form — using a 2-volume text, records, a low-cost electronic trainer and experimenter parts. Learn the latest for just

\$109⁹⁵

PLUS:

- Digital Clocks and Weather Instruments including NEW Floor and Shelf Clocks with synthesized Electronic Chimes.
- Marine Equipment including a NEW Chart Recording Depth Sounder.
- NEW Housewide Electronic Furnace/Air-Conditioner Air Cleaner.
- Stereo and 4-Channel Equipment including three NEW high-performance Speaker Systems.

Also Co or TV, R/C Gear, Amateur Radio Equipment, Smoke/Fire Detector, Test Instruments, MOFE.

MAIL COUPON TODAY!

Prices and Specifications
subject to change
without notice.

Heath Company,
Dept. 20-21
Benton Harbor,
Michigan 49022

HEATH

Schlumberger

Heath Company, Dept. 20-21
Benton Harbor, Michigan 49022

Please send me my FREE Heathkit Catalog. I am not on your mailing list.

Name _____

Address _____

City _____ State _____

Zip _____

GX-325

Circle 100 on reader service card

The IMSAI 8080.

A commercial yet personally affordable computer.



If you thought you could never afford a computer at home, think again. The IMSAI 8080 is built for rugged industrial performance. Yet its prices are competitive with Altair's hobbyist kit. Fully assembled, the 8080 is \$931. Unassembled, it's \$599. The IMSAI 8080 is made for commercial users, and it looks it. Inside and out. The cabinet is attractive, heavy gauge aluminum. The heavy duty lucite front panel has an extra 8 program controlled LED's. It plugs directly into the Mother Board without a wire harness. And rugged commercial grade paddle switches are backed up by reliable debouncing circuits.

The system is optionally expandable to a substantial system with 22 slots in a single printed circuit board. And the durable card cage is made of commercial-grade anodized aluminum.

The IMSAI 8080 power supply produces a true 28 amp current, enough to power a full system. You can expand to a powerful system with 64K of software protectable memory plus an intelligent floppy disk controller. You can add an audio tape cassette input device, a printer plus a video terminal and a teletype. And these peripherals will function with an 8-level priority interrupt system. BASIC software is available in 4K, 8K and 12K.

Get a complete illustrated brochure describing the IMSAI 8080, options, peripherals, software, prices and specifications. Send one dollar to cover handling to IMS. The IMSAI 8080. From the same technology that developed the HYPERCUBE Computer architecture and Intelligent Disk systems.

Dealer inquiries invited.

IMS

IMS Associates, Inc.
14860 Wicks Boulevard
San Leandro, CA 94577
(415) 483-2093

Dept. RE-9

KOMPUTER KORNER

Substituting microcomputer software for hardware

JOHN TITUS, PETER RONY, and DAVID LARSEN *

A READER WHO FOLLOWS THE CURRENT LITERATURE on microcomputers will frequently encounter phrases such as "hardware/software tradeoffs" or "substitution of software for hardware." These phrases are strongly indicative of anticipated applications for microcomputers in the near future and do much to explain why industry is so excited about them. In this month's column, we would like to discuss how it is possible to "substitute" microcomputer software for hardware.

Let us first recall the definitions for *software* and *hardware*:

hardware—The mechanical, magnetic, electronic, electromechanical, and electrical devices from which a system is fabricated.

software—The programs and routines used to extend the capabilities of computers, such as com-

hardware represents the specific devices that store, manipulate, receive or transmit digital information. The microcomputer itself is included in our definition of hardware. The purpose of this month's column can be simply stated as follows:

Through skillful programming it is

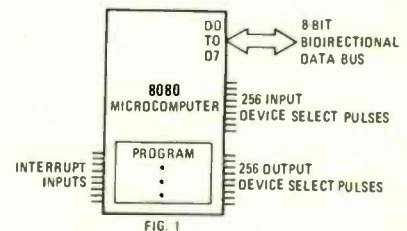

FIG. 1

possible to substitute machine-level routines and subroutines for specific hardware devices that store,

TABLE 1—SUBSTITUTION OF HARDWARE BY SOFTWARE.

SUBSTITUTED HARDWARE FUNCTION	NEW HARDWARE CIRCUIT	SOFTWARE EMPLOYED
1. PULSER, 500 ns MONOSTABLE	DS 0 → [Pulsed output]	OUT 0
2. LOW DUTY-CYCLE CLOCK (500 ns PULSES)	DS 1 → [Low duty cycle clock output]	OUT 1 : TIMING LOOP JMP
3. DEBOUNDED PULSER, MONOSTABLE, LOGIC SWITCH	DS 2 → [7474 SET/CLEAR] → [Pulsed output]	OUT 2 : TIMING LOOP OUT 3
4. VARIABLE DUTY-CYCLE CLOCK	DS 3 → [7474 SET/CLEAR] → [Variable duty cycle clock output]	OUT 4 : TIMING LOOP OUT 5 : TIMING LOOP JMP
5. ONE BIT OF CONTROL INFORMATION FROM A MECHANICAL SWITCH	DS 6 → [7475] → [Control signal output]	MVI A CTRL OUT 6
6. EIGHT BITS OF CONTROL INFORMATION FROM A SET OF EIGHT MECHANICAL SWITCHES	DS 7 → [8212] → [Control word output]	MVI A CTRL OUT 7

pilers, assemblers, narrators, routines and subroutines.¹

In our specific case, software represents the machine-language program that is stored within the memory of a microcomputer, and

manipulate, transmit, or receive digital information. This activity is called "the substitution of software for hardware."

Typical Substitutions

Typical hardware that is replaced includes knobs, buttons, pulsers, switches, logic switches, clocks, and small memories as well as TTL integrated circuits that perform

(continued on page 24)

* This article is reprinted courtesy of American Laboratories. Dr. Rony, Department of Chemical Engineering, and Mr. Larsen, Department of Chemistry, are with the Virginia Polytechnic Institute & State University. Mr. Titus is president of Tychon, Inc., a microcomputer consulting firm in Blacksburg, Virginia.

Easy as Spaghetti

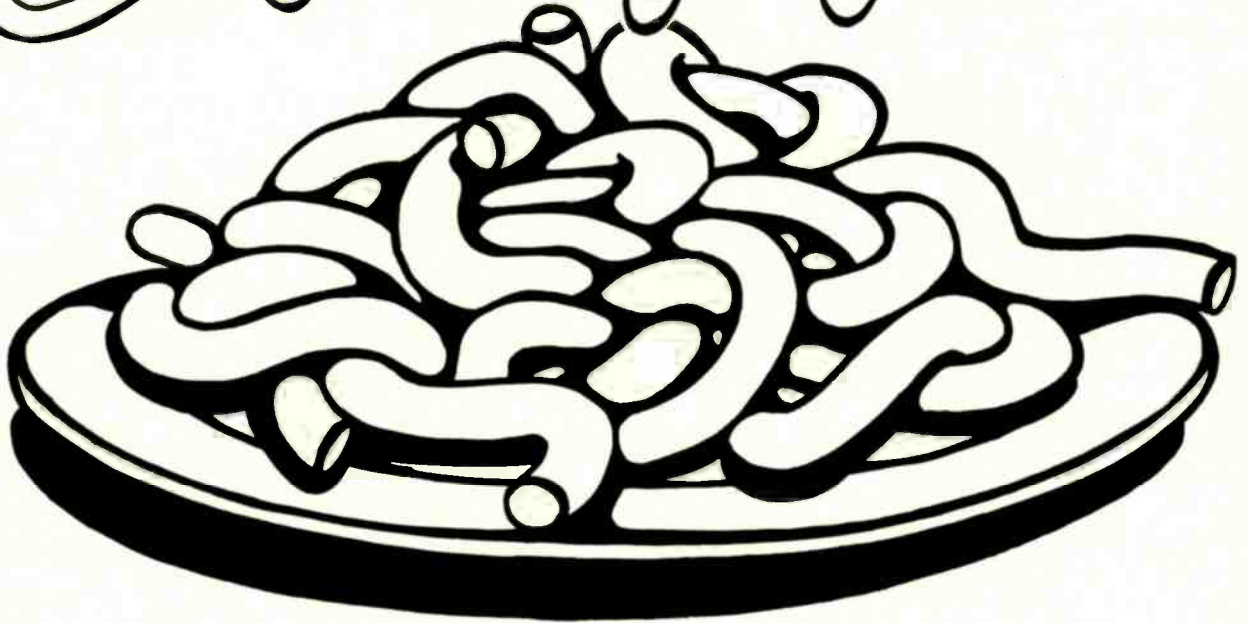

"Learning to use a computer should be roughly equivalent to learning how to make spaghetti!"

Personal Computing is the new people/computer magazine that understands this concept. We believe that if you are bright enough to:

1. Brown $\frac{1}{2}$ pound of hamburger in a large saucepan.

Add celery, 1 clove crushed garlic . . .

and etcetera, then you are probably bright enough to learn how to make practical use of your own, personal computer. You are probably bright enough to play games with it or make use of it for your own business or educational purposes.

Personal Computing looks at the computer as a handy, powerful mind tool. One that expands your ability to keep track of the many complicated aspects of a modern society.

The first issue of **Personal Computing** includes the following articles:

1. Part one of **Spaghetti BASIC**. Easy to learn course on programming a microcomputer in the simplest of computer languages, BASIC.

2. **Ten Steps to Becoming a Computer Hobbyist**. Tells you about the phenomena of this newest breed of electronic tinkerer. And if you'd like to join the fun, we'll try to guide you in the right direction.

3. **The Equalizer**. Zany feature by Nels Winkless III that views the personal computer as "the most powerful equalizer since the Colt 45 in the old frontier."

Personal Computing will provide educational articles on basic computer jargon, computer architecture, and computer programming. These articles will be written in easy to understand language for the beginner and they will serve as a reference for people already knowledgeable in the field.

Another regular feature on **Personal Computing** will be a section on "Future Computing." Also, each issue will include a poster sized, four color computer graphic.

Personal Computing is a new kind of magazine, completely different from existing hobbyist publications.

Benwill Publishing, the publishers of **Digital Design** and **Minicomputer News**, invites you to take advantage of a special, charter subscription offer. For a limited time only, you can subscribe to the first year of **Personal Computing** for only \$6. This includes a free copy of the initial, October-November kickoff issue, plus the six bi-monthly issues scheduled for 1977.

To subscribe to **Personal Computing**, fill out this coupon and return it with your check to:

Personal Computing

Benwill Publishing Corp., 167 Corey Road, Brookline, MA 02146, USA.

NAME _____

ADDRESS _____

CITY _____

STATE & ZIP _____

Note: \$6 special charter subscription rates apply to U.S. only. Mexico and Canada, \$12 surface mail and \$16 airmail. Foreign airmail: \$24. Charter rates increased \$2 after September, 1976.

KOMPUTER KORNER
(continued from page 22)

digital functions such as debouncing, sequencing, shifting, adding, subtracting, comparing, and logic operations on multi-bit digital words. Hardware that is *not* usually replaced includes simple TTL IC's such as inverters, flip-flops, gates, latches, three-state buffers, and counters.

Tradeoffs

Figure 1 illustrates the basic "tools" that you would employ in the substitution of software for hardware, namely:

1. Programming.
2. The use of synchronized data appearing on the bidirectional 8-

bit data bus, D0 through D7.

3. Input and output synchronizing pulses called *device select pulses*.
4. *Interrupts* to the microcomputer.

In an 8080-based microcomputer, you are able to generate 256 different input and 256 different output synchronizing-pulses. If you need more pulses, you can always employ memory I/O techniques. You therefore have an unlimited number of synchronizing pulses with which to coordinate the behavior of almost any type of digital electronic circuit. As you substitute software for hardware, your main tradeoff will be speed of operation. It is useful to remember the following rules when doing this:

In the substitution of software for hardware, the key tradeoff is speed of operation. The execution of any computer instruction takes time; the more instructions that are used, the longer it will take to execute them.

This tradeoff is not as serious as it may seem. Present 8-bit microcomputers are very fast, and future microcomputers will be at least ten times faster. The majority of existing electromechanical machines are slow by digital electronic standards. The human senses cannot participate in activities that require millisecond resolutions; i.e., in an input/output sense, we are very slow machines.

Practical examples

Table 1 summarizes some of the more commonly encountered situations where hardware such as debounced pulsers, switches, logic switches and clocks is replaced by simple wire connections, latches, flip-flops and inverters. We have provided abbreviated versions of the software required. The reader is referred to reference 2 for details on the generation of the OUT n pulses, where n is an octal number ranging between 000₈ and 377₈.

A "timing loop" is a short microcomputer subroutine that generates a precise time delay, typically greater than one hundred microseconds. As can be seen from the table, the replacement can be accomplished in most cases by the use of one or two different device-select pulses. A pair of OUT n instructions that bracket a timing loop are sufficient, when applied to an SN7474 flip-flop, to produce a monostable pulse of precise time duration. The addition of a second timing loop and a jump instruction changes the output of the flip-flop to that of a variable duty-cycle clock, the duty cycle being controlled by the relative time delays of the two timing loops.

Of particular interest is entry 6 in the table, in which an eight-position mechanical switch or eight individual mechanical switches are replaced by an 8-bit control word that is strobed into an 8212 IC from the accumulator with the aid of a device-select pulse. This control word is latched by such an action and can subsequently influence the behavior of a rather sophisticated digital circuit. The 8212 IC therefore functions as a *control register* for the circuit. We have directed your attention to this principle because it is now being widely used in an exciting new generation of *interface* chips that reduce the number of wire connections that need to be made between a microcomputer and an external device.

Table 1 provides only a few examples of how hardware can be replaced by simple software with the aid of device-select pulses. Omitted from the table are the more obvious hardware substitutions: arithmetic logic units (SN74181), digital comparators (SN7485), and shift registers (SN74194, SN74198, SN74199). Such IC's are replaced by microcomputer instructions that add, subtract, compare, and shift the 8-bit contents of the accumulator register. **R-E**

References

1. *Microprogramming Handbook* (Santa Ana, CA: Microdata Corp., 1971).
2. *Bugbook III Derby*, CT. E&L Instruments, Inc., 1975).

handic

Swedish-designed quality in cb accessories, too!

- 1) **FS-117 Universal Tester** — It's a power meter, SWR, a modulation meter, a crystal condition tester, and a tone frequency plus 27MHz signal generator! Checks entire CB band.
- 2) **SWR Bridge** — Measures field strength & SWR. Equipped with special Whip Antenna for checking SW conditions up to 1:3 on 50 Ohm cable.
- 3) **SP-1 Inline Watt Meter** — Monitors output power & SWR for top CB performance! 0-200W power range, 3-150MHz freq. range. Dual scale.
- 4) **LO-707 DC Converter** — Converts 6V to 12V (DC to DC) ... for use with all transceivers. Compact! Rugged.
- 5) **N-12-SA AC Adapter** — Converts 100VAC to 12VDC (2 Amp). Has variable control, electronic fuse & volt meter.
- 6) **HN/HMT Handset Telephone** — Handset telephone & holder with switch-over relay & cables. For all handic mobile & base units.
- 7) **"Powerpack" Sleeve** — Exclusive, portable power supply with stabilizer. Converts handic portables to mobile or base, connects directly to 12VDC — it's A Battery Recharger, too!
- 8) **BK-305 "Powerpack"** — Portable power supply. Converts handic's 3-Ch. mobile & 006 Mini-Scanner into portables! Uses normal dry cells or rechargeable batt'ys.
- 9) **Connectors** — Modern design, space saving, quality products for lasting connections. Use with cables, chassis & panel mounts, antennas, etc.
- 10) **Battery "10-Pack"** — Load into all handic portables and converted mobiles. Features 10 Nickel Cadmium batteries, rechargeable more than 1000 times.
- 11) **Speaker/Microphone** — Use with handic 4-Ch. & 6-Ch. portables that convert for mobile & base use.
- 12) **External Speaker** — A wide-range speaker design useful for cars, boats & indoors.
- 13) **Crystals** — 0.003% frequency tolerance 2 1/2 times better than FCC regulations! Assure high quality trouble-free performance.
- 14) **Antennas** — State-of-the-art design — 8 for portables; 6 for mobiles including motor-driven retractables; 2 marine types; and 2 base models. Noise suppressor kits also available.

Handic CB radios include: mobile/base transceivers; hand-held personal portable CB systems; scanners with FM radio option; antennas; microphones; selective call; and a full line of accessories.

Send For FREE Catalog!

Handic U.S.A. inc. 14560 N.W. 60th Ave., Kennedy Bldg., Miami Lakes, Fla. 33014 (305) 558-1522
In Canada: Scotcomm Radio Inc., Chomedey, Laval, Quebec

THE DEPENDABLE CB FROM SWEDEN

If you want an exciting future like this, it starts with an FCC license!

Get that license at home, the practical, step-by-step ETI way!

Just imagine yourself with the responsibility of running a radio or TV station. Or in command of an airport control tower. Imagine yourself as a technician on the job installing, troubleshooting or getting it all together for a two-way communications system at the local police or fire department. It's all great work and you can get it!

You may find hundreds of doors opening for you with that FCC license. An FCC license is required for thousands of exciting jobs. You'll be in demand! You'll be headed for a future doing a job you like. And you'll be getting a paycheck you'll like every bit as much. You'll have all the security and confidence that comes with being a licensed professional in an important career specialization.

Is FCC-license preparation hard to learn at home?

No. Sure, there is a lot to learn. And you'll need a thorough knowledge of the field. But through ETI's advanced instruction methods you can learn at home, expertly, and step-by-step, getting ahead as fast as your time and ambitions permit, because you set your own pace. Through ETI you get all the materials you need. You move ahead without missing a single day from your present job. Sooner than you expect, you'll be taking that FCC examination.

Exclusive five-year coaching agreement.

ETI offers you an exclusive five-year coaching agreement! When you complete the ETI FCC License Preparation Course, you should be qualified to pass the appropriate FCC examination. If



simply as possible, to pass the appropriate FCC examination. You are trained, detail by detail, to satisfy specific examination requirements for 3rd, 2nd, or 1st Class FCC Radiotelephone License examinations. And, by learning the ETI way, you approach that examination with confidence. You know what you need to know! And, if you want to combine FCC license preparation with more comprehensive electronics training, you may want to choose ETI's more detailed and thorough Communications Career Program.

you fail to pass, ETI will provide further coaching, until you do pass, for a period of up to five years.

Expert, personal help!

You get expert, personal help each step of the way. Electronics Technical Institute instructors are chosen for both their technical competence and their skill as teachers. They are licensed by the State of New Jersey. They care about you, because your success is their success. Each assignment you complete is a challenge to them. They comment... help... suggest... encourage... as well as correct and point you to the next step. They bring you along quickly!

Just what you need to know.

ETI's expertly perfected, practical FCC License Preparation Course is designed to do one thing: prepare you adequately, as quickly and

Get the facts FREE!

Don't cheat yourself out of finding out more. It's your future that's at stake. The facts are yours free and with no obligation. No salesman will call. The time to do it? Now! There'll never be a better time! Just fill out and return the coupon and we'll tell you everything about a future that can mean everything to you! It's all there in a colorful, fully illustrated new 44-page catalog!

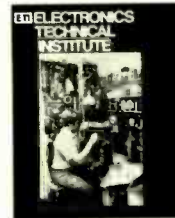

Electronics Technical Institute

Division of Technical Home Study Schools

Electronics Technical Institute, Dept. 2-479-096
Little Falls, New Jersey 07424

YES! I'm interested in a future with an FCC license. Rush me your free career information!

Send me information on these other fields of special interest:

- | | | |
|--|--|--|
| <input type="checkbox"/> TV/Audio Servicing
Black and White
Color
Solid-State
CATV
Closed Circuit
Video Recorders
Radio
Hi-Fi Stereo | <input type="checkbox"/> Computers
Digital Electronics
Computer Technology
Computer Programming | <input type="checkbox"/> Business and Engineering
Electronics Fundamentals
Electronics Drafting
Industrial Electronics
Advanced Electronics
Industrial Instrumentation
Electronics Technology
Medical Electronics |
|--|--|--|

Check here for Veterans Information.

Name _____ (please print)
Address _____
City _____ State _____ Zip _____

Circle 48 on reader service card

The Simple Solution to the I/O enigma.

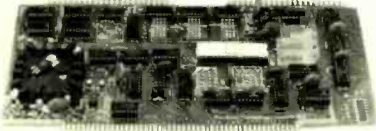

The **3P+S** module from **Processor Technology** is the most versatile input-output card for your Sol, IMSAI, or Altair system. It has **two 8-bit parallel I/O ports**, with full handshaking logic, and a **serial I/O port**. All on a single card.

Check this spiffy set up. Run a keyboard and a paper tape reader into your 8080 system; then, output a TV terminal and a tape punch, all via the 3P+S. And, you can still **simultaneously** run a modem (Telephone Coupler) in and out. We could write pages about the 3P+S' talents. We did, in fact. You can get our **59-page 3P+S Owner's Manual** (with schematics and applications) for **\$4.95**. If, then, you do buy our 3P+S, we'll refund the \$4.95.

3P+S I/O Module, Kit Price

with premium grade, low-profile sockets for every IC, **\$149**

Write Us about all our Sol/IMSAI/Altair compatible plug-in modules.

Processor Technology
6200-U Hollis Street
Emeryville, CA 94608

Circle 76 on reader service card

equipment reports

Sencore CB41 Automatic CB Performance Tester



Circle 102 on reader service card

MANY OF THE EARLIER CB ENTHUSIASTS WERE electronic hobbyists capable of installation and checkout of a CB installation. A substantial number of today's CB equipment buyers have no technical knowledge or ability and depend almost entirely on the dealer to provide installation, adjustment, and service where necessary. Fact is, on most Saturdays the average "auto radio/CB dealer" and service stations doing CB installations have waiting times running from three to five hours before their one or two "electronic technicians"—usually the kid who does the weekday lube jobs—can get to the basic mobile installation. Then, adjusting a short-whip antenna for minimum SWR can consume fifteen minutes to a half hour. And if the customer asks for proof the installation is *okay*, there goes another half hour as the technician connects test gear and then tries to explain what the readings indicate.

One of the ways to move CB installations along at a fast profit-making clip is to provide as much automation of the adjustments and checkouts as is possible. As far as the customer—the final user—is concerned, he can tell whether the receiver is working by how many stations he can hear. Few CB'ers ever question the receiver's performance; most CB'ers are primarily interested in RF power output, percent modulation and antenna system SWR—and it is these three performance characteristics that are most easily automated in an easy-to-understand manner for the non-technical CB'er.

Sencore Electronics, 3200 Sencore Drive, Sioux Falls, SD 57107, has come up with an answer. Full automation of the transmit and antenna characteristics is built into the new Sencore CB41 Automatic CB Performance Tester. This instrument measures RF watts in terms of average power for AM transmitters

or peak envelope power for SSB transmitters, SWR (standing wave ratio) in both absolute values (such as 1.5:1) and in terms of *green* (good), *yellow* (acceptable) and *red* (poor) scale calibrations, and percent modulation of an AM transmitter to 100%.

The CB41 actually consists of two units: the meter itself which is powered by two 9-volt transistor radio type batteries or an external 9-VDC power source, and a power sensing head that connects via a connector/socket to the meter. (You can add extensions between the head and meter if desired). The sensing head is basically a reflectometer that provides forward and reverse power sensing for SWR measurements and an RF sample for the power and modulation readings. It also contains a 50 ohm non-inductive resistor (25 watts max.). The sensing head is normally connected between the transceiver or transmitter and the transmission line. A switch on the head determines whether the antenna or the internal dummy load is connected to the transmitter.

Now all this reads as routine as most other CB test sets, so what justifies a suggested retail price tag of \$148? The difference is that readings are all automatic; there's no need to recalibrate the SWR meter for each antenna adjustment or calibrate the modulation meter to the transmitter's specific power output value.

The meter itself has three operating push-button switches in addition to the power and battery check switches. The SWR pushbutton provides a direct SWR reading without the need to calibrate for forward power—whatever the meter indicates as the SWR is the SWR regardless of the power output of the transmitter. If you are adjusting a mobile antenna, simply trim the antenna adjustment for the minimum SWR reading. You don't have to recalibrate the meter after each adjustment because that's done automatically by a built-in nulling circuit. Since you can track SWR continuously, a typical loaded antenna tuning for minimum SWR takes about 30 seconds; and the customer can see it all taking place without asking why you keep fiddling with the calibration knob.

Same procedure with the AM modulation measurements. Just press the % MOD switch and the meter automatically nulls the forward power calibration and the user can see the modulation reading directly, without questioning why you keep adjusting a calibration control. The percent modulation readings are calibrated for continuous tone, as can be provided by whistling into the microphone or by holding the mike in front of a small speaker connected to an audio generator. (The Sencore CB42 Automatic CB Analyzer contains the required generator and a special microphone coupling device. We'll do a report on the CB42 in a future issue.)

continued on page 28

ONE RIG DOES IT ALL!

Tube and Solid State

THE UNIVERSAL PJS-298

33KV LEADED GLASS 19" CRT

EIA recommended to protect against
dangerous X-radiation

A MUST FOR TODAY'S SERVICING

ACCESSORIES INCLUDE:

- CRT 90° Extension
- Yoke Extension
- Transverter
- Convergence Load
- Universal Yoke
- Convergence Assembly
- Blue Lateral Assembly
- Anode Extension

SOLD THROUGH DISTRIBUTORS ONLY

PLEASE SEND ME MORE INFORMATION S6

NAME _____

ADDRESS _____

CITY _____ STATE _____ ZIP _____



BUILT-IN SPEAKERS

Easy audio checking

40 KV METER

50aU sensitivity monitoring

FRONT CONNECTORS

Convenient cable plug-in

OBSOLETE PROOF

Plug in modules for up-dating

~~\$298.98 VALUE~~

SPECIAL INTRODUCTORY OFFER

\$229.95

COMPLETE WITH CRT

TeleMatic

2468 FULTON ST., BROOKLYN, NY 11207

Circle 61 on reader service card

Similarly, the peak envelope power output readings are calibrated for a two-tone generator.

You can, however, get meaningful measurements for a customer by just speaking into the microphone. For AM, the readings will be essentially the same as for tone. For SSB, the peak envelope power for voice will always indicate higher than 12 watts PEP (the legal limit) if all is okay. Note that regardless of claims by anyone, there is no general purpose meter-type test equipment that can indicate SSB PEP output using speech. For accurate measurements, a two-tone signal of 500 and 2400 Hz must be fed into the microphone (or microphone input).

The third CB41 function is power output. Pressing the RF WATTS pushbutton gives you the continuous AM (carrier) RF-output or the SSB PEP. By flipping the switch on the sensing head, the readings indicate the transmitter's output into the 50 ohm dummy load or into the antenna system.

While this might all sound easy, making the readings automatic is what makes it expensive, but also time saving—and time means more business to today's CB service center. Because of the CB41's forward power automatic nulling feature for the SWR and AM modulation readings, it is possible to test or checkout a new CB installation as fast as you can press three buttons; and you can adjust an antenna for minimum SWR in less time that it takes to calibrate the typical SWR

meter for the first reading. Best of all, you can obtain your readings right at the antenna even though the sensing head is at the transmitter because you can easily connect a home-brew extension cable.

Obviously, the Sencore CB41 is a little too sophisticated and high priced for the typical CB hobbyist, but it's the answer to the Saturday jam-up in most CB service centers. **R-E**

Vector P180 Slit-N-Wrap Wiring Tool

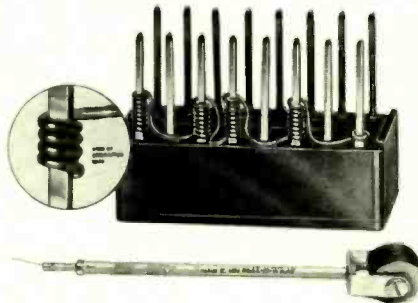

Circle 103 on reader service card

AT FIRST GLANCE THE P180 DOESN'T LOOK like much. But after a thorough examination and some on the job experience, your opinion moves to the high end of the scale. The tool is a 6-inch cylindrical tube with a wire spool at one end and a wire-wrapping bit at the other. A knurled finger-grip is provided for easy handling. It is made speci-

fically for use with No. 28 AWG nylon polyurethane insulated wire on 0.025-inch square posts. However, it does work with other posts, wire and methods by giving up some of the conveniences. The tool is funneled making it easy to thread. A hold-down spring puts drag on the wire to maintain correct wrapping tension.

To use the P180, take a breadboard that has been prepared with a matrix of wire-wrap terminals, pull a small length of wire out of the end of the tool that can be held secure, and then put the bit over the terminal and turn the tool smoothly in a clockwise direction. There is no prestripping of insulation as with conventional wire-wrap methods. The wire used is the same used in Vector's Model P173 solder-through wiring pencil. In this case, the insulation is scraped away when wrapping the terminal by a sharp edge where the wire leaves the wrap bit. If you look carefully at the dispensing end of the tool, there are actually two openings. The center round one is where the terminal fits. The second hole is a rectangular slot that is sharpened in one corner. Only when the wire is withdrawn at the proper angle by rotating the tool over the terminal in a clockwise direction does it contact the sharp edge scraping off the insulation. As long as the angle between the wire and tool is kept below 45 degrees there is no danger of damaging the insulation when dispensing wire between posts.

After the terminal has been wrapped with seven or so turns, the tool is simply lifted and an extra turn is looped around it to guard against shorts. The wire can then be routed to

When you think of receiving tubes, think of RCA and the man who's got them all.



the next point. Seven turns gives 28 points of contact for high reliability. A second instrument, the *P183* chisel knife and forming tool is a nice complement for trimming and holding the wire ends during the wiring operation. One end of the companion tool looks like a screwdriver but is actually a sharp knife-like blade. By pressing the *P183* against the wire and the board, the wire is neatly severed precisely where you like. The other end is insulated and will hold the wire when starting the wrap action and when routing the wire between posts.

If you don't believe it works, take apart a wrapped connection or two and look at the wire with a magnifying glass. You'll see where the insulation has been scraped away and where it has contacted and indented by the terminal post edges. That is essentially what I did in addition to making some resistance measurements of the completed wraps.

All this may sound very exacting, but is a very simple operation. No appreciable force or particular skill is needed. Excessive force should be avoided as it may create problems by breaking the wire. The head of the tool can be replaced when the cutting edge becomes dull, but Vector estimates its life to be over 10,000 connections. The whole operation is very clean and not a chore as some supposedly labor-saving gadgets actually turn out to be.

Round or rectangular terminals under 0.35 inch diameter will fit the center hole. If you really want to wrap other size or shape terminals such as round ones you can do it but you will have to solder the terminals to

make reliable connections. Remember that you can still use the solder-through wire and won't have to strip it first. Generally, it takes more care to solder this wire and longer applications of heat than with normal soldering techniques. Large terminals can also be wrapped in pencil-like fashion but this is pretty far afield from the purpose behind the tool.

Give some thought to where all the wires are going when you lay out the circuit since there is limited room on each post and it is wise to daisy chain from one to the next. In other words, wire from one post to another and then continue on without cutting the wire.

The Vector *P180* sells for \$24.50 with two 100-foot rolls of the No. 28 gauge wire. There is also a \$69 *P160 Electro Wrapper* which is a cordless power tool that spins the *P180*. The *P183 Chisel Knife Tool* is a \$1.95 option and \$8 replacement *P180* bits are available. Bits for other wire sizes will be available in the future. Wire is purchased at \$2.75 for a package of three 100-foot spools, and comes in green, clear, red, and blue. For further information, contact: Vector Electronic Company, Inc., 12460 Gladstone Avenue, Sylmar, CA 91342. **R-E**

Texas Instruments LCM-1001 Microprocessor Learning Module

THE LCM-1001 LEARNING MODULE USES THE TI SBP-0400 integrated circuit. Before looking

at the microprogrammer, some introduction is necessary since this device is different than the majority of the microprocessors you have seen written up. Actually the SBP-0400 is not a μ P but more correctly it is a 4-bit expandable parallel binary processor element. The I²L (Integrated Injection Logic) circuit is one step down in hierarchy from the μ P. To expand it into a μ P takes additional control logic and memory circuitry. Further expansion will convert the μ P into a full micro-computer.



Circle 104 on reader service card

The instruction set can have as many operations as the combinations of the 9-bit input microinstruction code allows—a total of 2⁹ or 512 instructions. The very flexible design of the processor element allows arithmetic and Boolean, logical shift, circulate, and register transfer operations, and combinations of these operations in a single clock cycle. To perform a single macroinstruction of a microprocessor, a series of microinstructions are carried out by the additional control



You name it and your RCA Distributor's got it. Glass tubes. Miniatures. Metal tubes. Novars. Compactrons. Nuvistors. Nearly 1100 types — all of the highest quality standards — the same standards that have made RCA tubes the most widely used.

And he's got what you need when you need it. You can count on your RCA Distributor to be well stocked — ready to supply you with RCA receiving tubes at all times.

Plus you can get RCA service and business aids, too. Get all the help you need with our popular caddies, service tools, technical literature and a wide assortment of in-store signs and displays. Your RCA Distributor will tell you how to get them.

Get your share of gifts — Tear 'n' Share '76. This RCA dealer awards program runs through November 30, 1976. Don't miss your share of the rewards for using RCA receiving tubes and color picture tubes. Ask for a Tear 'n' Share '76 Prize Book.

See your local RCA Distributor for all your tube needs. RCA Distributor and Special Products Division, Building 206-2, Cherry Hill, N.J. 08101.

RCA Receiving Tubes

Circle 57 on reader service card

circuitry and memory. A read-only-memory holds a microprogram or series of microinstructions that are executed for the specific higher level mP instructions.

The processor has a programmable logic array (PLA), an operation register (OR), an arithmetic logic unit (ALU), a relative position control, eight 4-bit register files (the 8th is the program counter), a working and extended register, and a number of multiplexers and busses.

The mask programmable PLA lets the user ultimately select the instruction code format he wants for specific operations. The standard factory PLA program has a very versatile set of 459 unique operations.

Two or more of the IC's may be chained to expand the computer word length in 4-bit

increments starting from a single SBP-0400 4-bit machine. Two input-terminals control the way data shifts are handled through the interconnected devices. They are set hard-wired to a logic 0 or a logic 1 according to whether the particular package is the most, least, or an intermediate significant package in the element chain. These terminals also determine the input/output assignments.

The LCM-1001 is essentially a rechargeable battery powered SBP-0400 with a control panel. The panel has microinstruction and data inputs, six control switches, and a total of 29 LED indicators. There is also a 40-pin socket for carrying out the more complex exercises and for expansion into a mC if desired. Each pin on the socket corresponds one-to-one to the SBP-0400, except for pin-40

which connects to the power supply.

The LCM-1001 is designed to teach about the SBP-0400 by the time proven hands-on method. A pushbutton clock-pulse generator lets you step through instructions one at a time. In this form it is *strictly* a learning module and should not be confused with an automatically clocked microcomputer system.

The unit comes with a 150-page instruction manual. Most other systems sorely lack this type of documentation. One word of caution—the manual is not written for the beginner and reference is made to a text for the necessary background information.

You are warned by the manual that you cannot skip the important early part of the text and expect to get anything out of the LCM-1001 by "playing" with the switches. And of course if this is what you attempt you've simply wasted the purchase price. After you read through the detailed descriptive material and have at least digested a portion of it, you can then move on to the module itself and begin to run some simple programs. You will find yourself going back to the previous material. It is during this phase that you will actually begin to understand what is going on. As you work the examples, you are encouraged to try some of the ideas that come into your head. For example, you might try to get the same results as a text program in some other way. You can also attempt to see how a microprocessor, such as the TMS8080, works by writing a series of microinstructions that carry out some of the operations in the 8080 instruction set.

There is a real need for this type of module that for \$149.95 allows understanding of the computer at its most elemental microinstruction level. The learning module is a very neat plastic enclosed $6\frac{3}{4} \times 5\frac{1}{2} \times 2$ -inch package. After the hobbyist, technician or engineer has mastered the basic concepts he can then go on to make his own controller and I/O interfaces. Three follow-on modules are planned for future release. They are a PROM controller, memory, and input/output modules.

Inquiries should be sent to Texas Instruments Incorporated, Inquiry Answering Service, P.O. Box 5012, Mail Station 84, Dallas, TX 75222. **R-E**

**If You're The Kind
Who Demands
The Best...
We've Got
To Hand It To You**

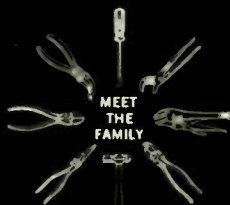

Send For Our Free Catalog

This is the one with the smooth working, machined, undercut mating parts (1) that can't slip out.

This is the one with the reinforcing flange (2) that practically eliminates stress breakage.

This is the original. The first of its kind and still the best of its kind. CHANNEL-LOCK. Be sure you get the real thing. Look for the trademark on the handle.

CHANNEL-LOCK, INC., • Meadville, Pa. 16335

CHAN NEL LOCK

The ORIGINAL Tongue-'N'-Groove

Hickok Model 217 Semiconductor Analyzer

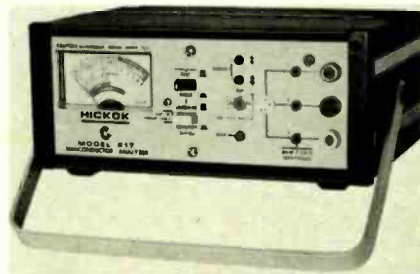

Circle 105 on reader service card

INTEGRATED CIRCUITRY IS BECOMING MORE and more useful in service-type test equipment. The Hickok Electrical Instrument Co. has a line of automatic transistor analyzers that is a good example of this. Starting with the *Baby Bear*, the shirt-pocket size model *continued on page 32*

Circle 3 on reader service card

Realistic is out front in cassette decks!



a giant step
forward for your
system:

the new front-loading SCT-11 with Dolby on tape and FM.

Most decks give you Dolby* noise reduction only on tape. But the Realistic® SCT-11 also brings improved fidelity to FM — by plugging into your receiver's tape monitor and decoding Dolbyized stereocasts. You can stack this deck or install it between shelves, because everything's out front. Lighted cassette compartment. Oversize VU meters. Bias selector for finest sound from

standard or CrO₂ tape. LED function indicators. Dual concentric recording level knob. And you get full Auto-Stop, plus automatic recording in mono, on both channels, when only the left channel is plugged in. Ask for 14-849, pay only 229.95 at participating stores, get the out-front deck that leaves others behind. Walnut grain vinyl-over-metal case included.

**ALMOST TIME TO GET YOUR NEW
RADIO SHACK 1977 CATALOG!**



**FREE AT OUR 4200 USA
STORES AND DEALERS
STARTING SEPTEMBER 1st!
EXCITING 56th ANNIVERSARY EDITION
EXCLUSIVE ON ALL 164 PAGES
OVER 2000 ITEMS • FULL COLOR
Hi-Fi • CB • Radios • Phonos • Recorders
Tape • Kits • PA • Intercoms • Parts**

SOLD ONLY WHERE YOU SEE THIS SIGN:

Radio Shack®

A TANDY CORPORATION COMPANY
OVER 5000 LOCATIONS • 50 STATES • 9 COUNTRIES

Just Say "Charge It"
at participating stores



*Dolby is a registered trademark
of Dolby Laboratories, Inc.

Retail prices may vary at individual stores and dealers.



A Warning To My People.

The microcomputer revolution is in danger! Unscrupulous mercenaries have infiltrated our ranks. They promise new freedom, but their equipment is an insult to our cause. High priced toys with blinking lights. Useless frills. TIC TAC TOE games. Incomprehensible manufacturer's specifications masquerading as teaching material.

Do not settle for inferior devices. Arm yourselves with E&L Instruments' MMD-1. The Mini-Microcomputer with important advantages.

- A complete system of self-instruction. Provides understanding of microcomputer technology as well as specific instruction on our MMD-1.
- 8080A CPU, keyboard entry of data and instructions, LED indicators.
- 256 words of R/W memory, and 256 of PROM, programmed for keyboard entry of data.
- Buffered connector outputs for system protection and expansion.
- Built-in interfacing breadboarding socket provides access to input/output bus lines and other critical control lines.

Choose from 2 different battle plans:

MMD-1A: Complete, assembled, tested Mini-Micro Designer with software modules...including Bugbook III \$500.00

MMD-1K: Complete parts in kit form and PC Boards necessary to build Mini-Micro Designer...including Bugbook III \$350.00

Your MMD-1A or MMD-1K can be ordered directly from Circuit Design, Inc. Please complete coupon below:

CIRCUIT DESIGN, INC.

Division of E&L Instruments
P.O. Box 24, Shelton, Conn. 06484

Please send me MMD-1A
(Price \$500.00).

Please send me MMD-1K
(Price \$350.00).

Name _____

Address _____

City _____ State _____

Zip _____ Telephone _____

Enclose check or money order, or numbers from BankAmericard or Master Charge. Postage will be prepaid anywhere in continental U.S.

EQUIPMENT REPORTS

continued from page 30

215, it goes to a middle sized (*Mama Bear*) model 217, and then to *Papa Bear*, the larger model 220. The model 215 has been previously reviewed, and now we come to the model 217. This uses the same automatic test circuitry. Well, almost completely automatic; you do have to hook up three test leads! After that, the internal circuitry does all the rest. These will test any transistor in-circuit or out-of-circuit—bipolars, JFET's, UJT's, diodes, Zeners, SCR's, Triacs, etc.

The three color-coded test leads have the EZ-Hook miniature clips and can be easily connected to any transistor. Even if there is only a little bit of lead showing. If there isn't, you can use a handy three-pin probe. This probe has very sharp tips and will penetrate any coating, insulation, etc. The three pins are adjustable. Then you push the switch on the 217 to TRANSISTOR and it does the rest. It scans all possible combinations of the three leads. When it comes to the right one, it files this away in its memory. At the end of the scan, the panel lights tell you whether the transistor is GOOD, BAD, NPN or PNP, and also which lead is the base (or the gate if it is an FET!). It will make in-circuit tests of any transistor that has more than 500 ohms of impedance shunted across it.

If the circuit has less than this, the 217 will read it as bad. The lights will keep on blinking and the BAD light comes on. However, the manual cautions you that any transistor reading BAD should be taken out of the circuit and retested. If it reads BAD now, then it is. I verified this. I checked out one of the little orphan radios that are so common now. The 217 picked out three bad transistors in the blink of an eye. (Should have said "Blink of an LED", for that's what all the indicator lights are.) There is one extra feature. If you hook the 217 to the output transistors of a radio, especially transformer-coupled types, you'll hear the "beep" of the scanning signal! Automatic test of speaker and output transformer for open circuits!

If the switch is turned on with the test leads open, all lights blink and the BAD light glows. This is the normal indication.

The model 217 is very handy for testing transistors before you install them. I had a couple of odd-ball transistors that I was going to use in a radio. Testing these showed that the package marking was wrong! The base wasn't on the lead they showed. Things like this can save a whole lot of time.

When testing, the lights blink as soon as the switch is turned on. They will keep on for one second; this is all it takes to make a complete scan! If the transistor is good, it will then light the appropriate lights to indicate polarity, base location, etc., and hold this for 3 or 4 seconds. Then, the cycle starts over again. For diode testing, only leads 1 and 3 are used. Throwing the switch to DIODE, starts the test. The GOOD N or GOOD P light will come on if the diode is good. The panel markings show which test lead is on the anode and which one is on the cathode. This can be very handy for identifying the cathode on those diodes that are so small you can't even see 'em, let alone read any markings. A 3-pin transistor socket is mounted on the panel; lines from each pin go to the banana jacks for base identification.

The 217 has a very unusual panel meter.

This is used for leakage and identification tests. These tests should be made out-of-circuit for valid results. To read leakage, hook up the transistor and wait till the circuitry has finished cycling, then push the TEST-HOLD button. The leakage can then be read directly on the meter. The meter is a little unusual. It is specially designed so that it can read leakages from 1.0 microamp up to 5.0 milliamps—all on a single scale. A range of 50,000 to 1! (Talk about nonlinear!) This test will read either I_{cbo} or I_{ebo} of transistors, or I_{gss} of FET's.

For identifying the type of material, Ge or Si, push the TEST-HOLD switch and then push the LEAKAGE-IDENTIFY switch. The transistor will be identified by the meter reading. If the meter is in the orange scale, the device is Si. If the meter is in the blue scale, the device is Ge. Transistors with excessive leakage will throw this off. The allowable leakage for power or signal transistors, for each type, is shown by special scales on the meter.

The model 217 can be powered from the AC line or from two 9-volt transistor batteries. These may be the stock types or rechargeable NiCad types. A built-in circuit may be hooked up for recharging. The BATTERY-AC selector switch is located in the handy compartment on the top, where the line cord and test leads are stowed. A handy bail-type handle is used to prop it up for the easiest use on the bench.

The manual gives you simple tests that can be made to make sure that it is working properly. This requires only a good silicon transistor, a meter able to read 1.0 mA and 5.0 mA, and a decade resistance box. The circuitry used is durable and normally trouble-free. A one-year warranty is given with provisions for one more year at a nominal charge.

A very handy instrument and one that meets the prime requirement for all commercial test equipment. Properly used it can pay for itself in time saved, in only a short time.

For more information contact: Hickok Electrical Instrument Co., 10514 Dupont Ave., Cleveland, OH 44108. **R-E**

Town Board orders Cablevision to cease repair of local TV's

As a result of representations made by the local Television and Electronics Service Association (TESA), the Oyster Bay (New York) Town Board ordered Cablevision of Jericho to "cease and desist" from offering TV repair contracts to the more than 30,000 cable customers in the town.

Neil Gaylor, president of the local TESA, appeared at the board meeting with a delegation from the Association. He stated that Cablevision was not only undercutting standard service contract rates—normally \$125 per year—of the 400 service shops in the area, but that more than 1,000 persons would be out of work if the practice continued.

Cablevision's franchise prohibits the company from going into the repair business. The contention of Cablevision's attorney that the company was merely acting as an agent for Broadway Maintenance, which does the actual repair work, was brushed aside by town attorney Joseph Colbey. "Broadway Maintenance is an alter ego of Cablevision, subject to the same restrictions," he said. **R-E**

For a winning deck, pick a Sansui.

SC 636

With the development of the Sansui cassette decks, the cassette can truly be called a high fidelity medium. Only with the technical accuracy and near perfection of these Sansui models can the musical recording and reproduction do full justice to the capabilities of the cassette being used.

The new Sansui vertical front-load series has achieved extremely low wow and flutter by isolating the capstan drive from the reel drive. This is accomplished by a slip-free drive belt coupled to a mirror finish, extra large flywheel. Our new decks incorporate the newest Dolby* IC chip technology to give you a full 10 dB improvement in signal-to-noise ratio. All mechanical controls are inter-locked so you can go directly from any mode to any other without going through stop, to prevent damaging valuable tape.

The SC-3000 and SC-3003, top-of-the-line models with 0.09% (WRMS) wow and flutter are stacked with attractive features: front-access tape compartment positioned right-side up, fully automatic stop-shut/off, a reliable and easy-to-read 3-digit tape index counter with a very useful Memory Rewind Section, highly accurate VU meters, peak level indicator, extremely hard Permalloy record/playback head for long life and outstanding performance.

All four models in this Sansui series, from under \$290.00** to under \$370.00,** share many of the same outstanding features for true high fidelity performance at attractive prices.

The Sansui SC-636¹ at under \$280.00,** a leading all-around deck, delivers fine quality sound without costly frills. As with the higher priced models, the SC-636 offers fully automatic shut/off, illuminated VU meters, built-in Dolby* Type B Noise Reduction System, low wow and flutter and an excellent signal-to-noise ratio.

Sansui has stacked its decks. Stop in at your nearest franchised Sansui dealer today and buy one of these outstanding new Sansui series to stack yours.

- * Dolby is a trademark of Dolby Laboratories Inc.
- ** The value shown is for informational purposes only. The actual resale price will be set by the individual Sansui dealer at his option.
- ¹ Simulated walnut grain



SANSUI ELECTRONICS CORP.

Woodside, New York 11377 • Gardena, California 90247
SANSUI ELECTRIC CO., LTD., Tokyo, Japan • SANSUI AUDIO EUROPE S.A., Antwerp, Belgium
In Canada: Electronic Distributors

Circle 91 on reader service card

Sansui

Are you,
of all people,
still opening
your garage

the
hard
way?



Anybody who's into electronics

certainly should be getting the everyday convenience and family security of automatic garage door operation... especially now, with Perma Power's great Electro Lift opener...

made to fit in the trunk of your car, designed for easy handling and simple do-it-yourself installation.

Available now at a surprisingly low price from your distributor.



P.S. Show off your opener to your friends and neighbors. You'll probably be able to pay for yours with what you make installing openers for them.

Perma Power®

Chamberlain Manufacturing Corporation
Perma Power Division
5740 North Tripp Avenue, Chicago, Illinois 60646
Telephone (312) 539-7171

Circle 45 on reader service card

New digital relay system uses frequency-shift keying

Increasing digitization of communications traffic, the need to use higher frequencies to meet future transmission capacity requirements, and economical aspects are among the reasons cited by Siemens for introducing a new microwave relay communications system, the PSK

keying at 15 GHz. Information is contained in the phase shifts at 0, 90, 180 and 270 degrees. Transmission is at the rate of 8.448 megabits per second.

All transmission and reception equipment is contained in a weatherproof housing roughly 27 x 27 x 14 1/2 inches, the front of which acts as the parabolic antenna. A total of eight transmitters and eight receivers can be used with one antenna. Four employ vertical and four horizontal polarization. Capacity is 1920 voice channels in two 120-MHz wide bands. Power is one-tenth or one-half watt, as desired.

Relay hop distances vary according to conditions; rainfall figures for Germany indicate spacings of about 14 to 18 miles between antennas.

Input unit for ELF transmitter helps submarine communications

An electronic device that enables a land-based transmitter of sufficient power to communicate with deep-cruising submarines almost anywhere in the world has been shipped by Sylvania to the Navy Test Facility in northern Wisconsin.

Known as an Input Message Processor Terminal, it includes a modulator, a teletype machine and a computer program. Under program control it encodes messages and modulates the ELF transmitter at the Wisconsin test facility.

The ELF band (30 to 300 hertz) is the only one useful for communicating with submarines deep in the water. Submarines can receive necessary messages on that band without rising to the surface, reducing the danger of detection and destruction. The Wisconsin test site has a buried antenna of fantastic size for such communications.



THE SIEMENS PSK 120-240/15000

120-240/15000. The equipment is now undergoing tests by the German postal administration.

The system operates with phase-shift

NESDA EVALUATES MAGNAVOX EQUIPMENT



NESDA SERVICEABILITY EVALUATION TEAM are evaluating the Magnavox T-995 and T-991 chassis at the company's Fort Wayne (IN) engineering laboratories. Left to right, standing are Dean Mock, Bob Schladetsch, Steve Carpenter, James Smith. Foreground, kneeling: Stu Leightner.

Automatic Frequency Counting and Display to 60MHz with 1Hz Resolution



BK PRECISION MODEL 1801, \$240

For laboratory, production line or maintenance applications, the Model 1801 will meet most requirements for sensitivity, ruggedness and dependability. With the Model 1801 you can watch oscillator adjustments, monitor RF and audio frequencies precisely, do fast production testing, check critical countdown chains, calibrate signal generators and check CB frequencies.

Automatic ranging 20Hz—40MHz is guaranteed. Ranging to 60MHz is typical. Reliable TTL circuitry updates the six-digit display five times per second. Resolution to 1Hz is obtained by switching to the 1SEC mode that suppresses the leading digits above 1MHz.

Specified accuracy better than 10PPM, 0-50° C. Maximum aging rate 10PPM/year.

The 1801 is compatible with prescalers that will extend its usability into the UHF range.

For detailed specifications and a no obligation, 10-day free trial, contact your local electronic distributor or B&K Precision.



MHz display of 3.579548 MHz input (AUTO mode)



KHz display of overflow of 3.579548 MHz input (1SEC mode)

BK PRECISION
PRODUCTS OF DYNASCAN

6460 W. Cortland Avenue
Chicago, IL 60635 312/889-9087

State of SOLID STATE

Microprocessors—assembling a system,
software and system modules

KARL SAVON
SEMICONDUCTOR EDITOR

YOU'VE FINISHED READING THE MANUALS AND you have a working knowledge of the microprocessor instruction set. Waiting in front of you is a set of IC's to build your microcomputer. Suddenly you are hit with cold reality: How do you put this thing together and get it to run? And how do you get that program you've been working on into the memory?

Getting started

So I'll make a recommendation. Take a serious look at what's available in microcomputer kits. Assuming you've already decided on the microprocessor you want to work with, be it the Motorola M6800, the Intel 8080, the MOS Technology MCS6502 or the Fairchild

F8, the field is narrowed and you can choose a microcomputer kit depending on the final goal and cost. You'll find relief in having all the busses and control wires connected for you as well as the input/output interfaces taken care of.

It's one thing if you're an experienced computer engineer and have a good idea where everything should go. But if you're a novice or even an experienced technician or engineer lacking in microcomputer savvy, the breadboarding kit route will save you lots of woes. No matter what you've heard, the microprocessor is not simple for the beginner to use. The manuals, diagrams, and software that are provided with the kit will be invaluable in getting your system working and in learning the less obvious details quickly.

If you are really determined to do your

own thing and insist on making PC boards etc., then at least start with a system schematic provided by the microprocessor manufacturer.

The numerous breadboarding systems on the market—such as the MITS Altair 8800 and 680, the Microcomputer Associates JOLT kits, the Electronic Product Associates Micro-68, Control Logic's L and M series, Cramerkits, E & L Instruments MD-1 and the Sphere OCC—come with assortments of CPU's, power supplies, input/output interfaces, and programming and control methods. A bank of switches and indicators may be provided or there may be a more sophisticated teletype or video display interface. If you already own a TV typewriter, you are way ahead of the game. Front panel switches

(continued on page 112)

NEW

"FERRET" TV MINI-ANALYZER FOR FAST STEP-BY-STEP TROUBLE SHOOTING

SUB TUNER

VHF AND UHF TUNER FOR RAPID TESTING OF ALL CHANNELS. CALIBRATED GAIN ADJUSTMENTS PROVIDE FOR SIGNAL STRENGTH COMPARISON.

DIGITAL GENERATOR

CRYSTAL CONTROLLED FOR GENERATING STABLE PATTERNS WHEN CONVERGING RED, GREEN AND BLUE GUNS. IDEAL FOR LINEARITY, PIN CUSHION, CENTERING, FOCUS AND ALL PICTURE ADJUSTMENTS.

40 MHz OUTPUTS

IF SIGNALS FROM DIGITAL GENERATOR AND SUB TUNER FOR STAGE-BY-STAGE ANALYZING AND TROUBLE SHOOTING.



SG 785 \$99.95

GENERATOR SECTION

CROSS-HATCH

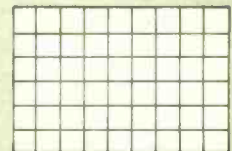

LINEARITY ADJUSTMENT

STANDARD FOR VERTICAL AND HORIZONTAL POSITIONING, PICTURE CONTRAST, IF BANDWIDTH TEST

DOT PATTERN

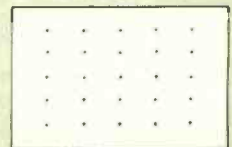

CONVERGENCE ADJUSTMENT

STATIC AND DYNAMIC CONVERGENCE, BEAM ADJUSTMENTS.

The VHF/UHF section of the Ferret allows direct substitution of the TV's tuner for fast, positive localizing of front end trouble.

The crystal controlled digital circuitry assures complete accuracy of both the vertical and horizontal frequencies. Accuracy is better than .005%. Output from the generator may be coupled thru the tuner section or directly to the IF-video stages. Resolution is limited only by the picture quality of the TV receiver. Operates from 105 to 125 volts 50-60Hz.

SOLD THRU DISTRIBUTORS ONLY

Please send me more information. **\$6**

Name _____

Address _____

Code _____

TeleMatic 2849 FULTON STREET, BROOKLYN, NY 11207

SWTPC 6800

#1

IN PERFORMANCE

The word is getting around. There is simply no better processor available for general purpose computer work than the Motorola MC6800. This memory oriented processor is easier to program and makes possible more efficient, shorter and faster running programs than the old fashioned bus oriented processors. Have you been convinced that machine language, or assembler programs are only for the experts? Well not with a modern 6800 based computer. Anyone can learn very quickly with this simple straightforward hexadecimal notation processor. When you add to these advantages the unique programmable interfaces and the Mikbug® ROM you truly have a "benchmark" system.

Mikbug® eliminates the tedious and time consuming job of loading the bootstrap program from the switch console each time the computer is turned "On". With Mikbug® this is automatic and you simply don't have switches and status lights. It has been said (not by us) that a switch console is essential for "hardware development," (perhaps they meant "hardware debugging"). Anyway the SwTPC 6800 system has no need for either. This is a fully developed, reliable system with no strange habits. All boards have full buffering for solid noise immune operation. One crystal type clock oscillator drives everything, processor interfaces and all; so there are no adjustments and no problems.

FOR VALUE

The SwTPC 6800 in its basic form comes complete with everything you will need to operate the computer except an I/O device. This may be either a teletype of some kind, or a video

terminal. You get a heavy duty anodized aluminum case, a 10 Amp power supply large enough to power a fully expanded system, a mother board with seven memory/processor slots and eight interface slots, a 2,048 word static memory and a serial control interface. This kit is now only \$395.00. It was introduced at \$450.00, but when processor prices went down we reduced the price of the kit accordingly.

As an owner of our 6800 computer you will get copies of our newsletter with helpful information and software listings. We have a library of software including all the common computer games and our fantastic BASIC. This is available to you for the cost of copying, you don't have to buy anything to get this material.

What more could you want? Pay a visit to our nearest dealer and see the 6800, plus our new cassette interface, graphics terminal and printer. He will be happy to demonstrate our system and to supply you with a 6800 that will fit your exact needs.

Mikbug® is a Motorola Trademark



with serial interface and 2,048 words of memory. \$395.00

Southwest Technical Products Corp.
219 W. Rhapsody
San Antonio, Texas 78216

- The Computer Store, 820 Broadway, Santa Monica, Calif. 90401, (213) 451-0713
- Cyberdux, Microcomputer Applications, 1210 Santa Fe Dr., Encinitas, Calif. 92024 (714) 279-4189
- The Micro Store, 634 South Central Expressway, Richardson, Texas 75080 (214) 231-4088
- ELS Systems, 2209 N. Taylor Rd., Cleveland Heights, Ohio 44112 (216) 249-7820
- Microcomputer Systems Inc., 144 S. Dale Mabry Ave., Tampa, Florida 33609, (813) 879-4301
- William Electronics Supply, 1863 Woodbridge Ave., Edison, N.J. 08817 (201) 985-3700
- Computer Mart of New York, Inc. 314 Fifth, New York, N.Y. 10001 (212) 279-1048
- The Byte Shop Computer Store # 1, 1063 El Camino Real, Mountain View, Calif. 94040, (415) 969-5464
- The Byte Shop Computer Store # 2, 3400 El Camino Real, Santa Clara, Calif. 95051, (408) 249-4221
- A-VID Electronics Co., 1655 E. 28th Street, Long Beach, Calif. 90806 (213) 426-5526
- Computer Warehouse Store, 584 Commonwealth Ave., Boston, Massachusetts 02215 (617) 261-1100
- The Computer Workshop, Inc., 11308 Hounds Way, Rockville, Ind. 20852 (301) 468-0455
- The Computer Store, Inc., 120 Cambridge Street, Burlington, Mass. 01803 (617) 272-8770
- Marsh Data Systems, 5405 B. Southern Comfort Blvd., Tampa, Florida 33614 (813) 886-9890
- Midwest Enterprises Inc., 815 Standish Ave., Westfield, New Jersey 07090 (212) 432-2066
- The Milwaukee Computer Store, 6916 W. North Ave., Milwaukee, WI 53213 (414) 259-9140
- Control Concepts, P.O. Box 272, Needham Heights, Mass. 02194
- American Microprocessors, Equipment & Supply Corp. at Chicagoland AirPort, P.O. Box 515, Prairie View, Illinois 60069 (312) 634-0076
- The Computer Room Inc., 3938 Beau D'Rue Dr., Eagan, Minn. 55122, (612) 452-2567
- Computerware, 830 First St., Encinitas, Calif. 92024 (714) 436-9119
- Atlanta Computer Mart, 5091 B Buford Highway, Atlanta, Ga. 30340 (404) 321-4390

Wilson

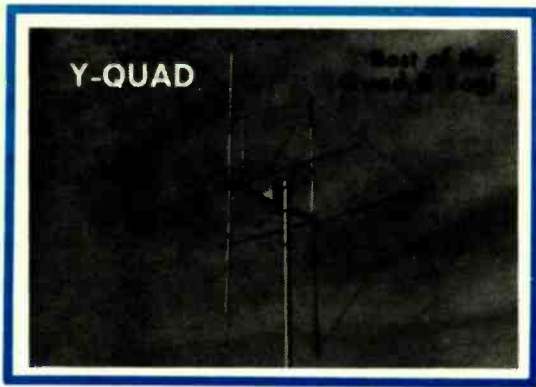

• WINNING COMBINATION •

The Y-Quad combines the best of the Quad & Yagi designs giving one of the best performing switchable polarity lightweight antennas on the market. Uses a Quad Reflector and Yagi driven element.

• ANGLE OF RADIATION •

The Quad Reflector assures low angle of radiation even at low heights for real long distance performance.

• FRONT TO BACK •

The Quad Reflector gives an excellent front to back ratio of 25-30 dB along with a forward gain of 10.5 dB.

• DUAL POLARITY •

This feature gives considerable improvement in the following types of communications:

- A. Maximum transmission to either base or mobile stations.
1. Mobile antennas are invariably vertically polarized.

arized antennas, switching to the vertical mode of the Y-Quad allows effective communications with these mobiles.

2. Base to base transmissions are most effective using horizontal polarization.

B. Line of sight transmission

1. By shifting polarity, you shift the signal 90° thereby reducing the received signal in the opposite polarity by as much as 20 dB. Good gain with other station is still maintained if polarity is matched with yours.
2. Good front to back and front to side rejection of unwanted signals in both polarities.

• SPECIFICATIONS •

- Gain 10.5 dB
- Front to back ratio 25/30 dB
- Boom length, 6 ft.
- Weight, 12 lbs.
- Horizontal or vertical polarity
- JMP 50 Ω Gamma Match
- Power capability, 2,000 watts
- Can be turned with small TV rotor
- Fiberglass Spreaders

Wilson
Electronics Corp.

SHOOTING
STAR

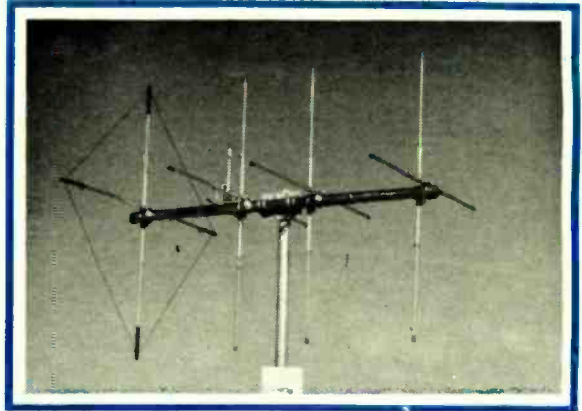

The 8 Element Shooting Star was developed to fill the need for a top performing, high quality, dual polarity antenna at a reasonable price. Its design is the same as antennas used to bounce signals off the moon using 1/2 wave dipoles and quad reflector.

The design uses a scientifically matched boom of 16' and precision spacing to give the very best gain and front to back combination possible. A quad type reflector is used to increase gain and improve front to back ratio. Gamma matches are used to obtain the best impedance match, eliminating coils which burn out, allowing a 2 KW power handling capability.

The mechanical construction is superior to other antennas as we use extruded aluminum boom to element clamps which do not require drilling holes in the elements. All aluminum tubing is heavy wall aircraft type. Uses same construction as the famous Laser beam.

With dual polarity you can switch to vertical and work the mobiles or local stations and when things get rough, switch to horizontal and eliminate interference as much as 25 dB.

- Gain 14.5 dB
- SWR 1.3 to 1
- Impedance 50.52 Ohms
- Power Handling Capabilities 2,000 watts
- Front to Back Ratio 38 dB
- Vertical - Horizontal Separation - 25 dB
- Weight - 29 lbs.
- Boom - 2'
- Recommended Rotor - CD44 or Ham II
- Fiberglass Spreaders

ALPHA V58

5/8 Wave
Ground Plane

The Alpha V58 is a full 5/8 wave ground plane with four full size radials, using a loop for loading which eliminates the need for a coil that could easily burn out. The use of DC ground reduces the static noise and gives a cleaner received signal.

Superior to all other verticals, Wilson uses a new "Adjustable Capacitive Coupling System" in the V1 & V58, to enable you to achieve a flat 1:1 SWR in the widest range of installations.

- Gain 5, 14 dB
- 4 full length radials
- Loop loading
- 1:1 to 1 SWR
- No coils to burn out
- Will handle 2,000 watts
- Height, 21 ft.
- Weight, 7 lbs.
- New radial hub design

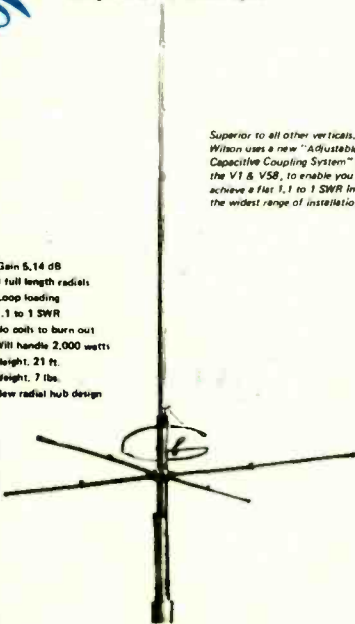

V1

5/8 Wave Ground Plane
Without Radials

Our V1 is a 5/8 wave vertical ground plane without radials.

It's the perfect antenna campers and mobilers like to have for portable operation. It is quick & easy to set up or take down. Be on the air in less than 5 minutes after arriving at your camping spot.

- Gain 3 dB
- No radials
- Loop loading
- 1:1 to 1 SWR
- Will handle 2,000 watts
- Height, 21 ft.
- Weight, 5 lbs.



Ideal
for campers or
portable operation

WILSON ELECTRONICS'
SUPER LASER 500

THE MOST POWERFUL AND DIRECTIVE CB ANTENNA IN THE WORLD

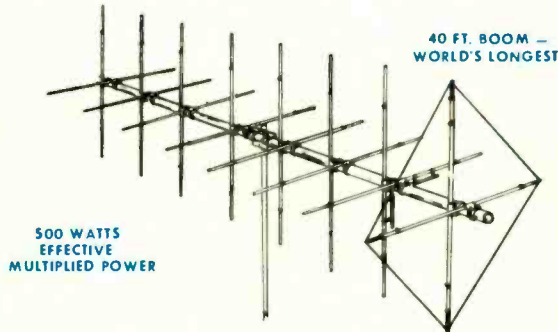

40 FT. BOOM -
WORLD'S LONGEST

500 WATTS
EFFECTIVE
MULTIPLIED POWER

The Super Laser's tremendous Gain and Directivity, with the great rejection of unwanted signal, will enable you to hear and talk to stations that before were just noise in the pile of heterodynes. Your normal CB rig will develop an effective power of 500 watts, and the received signals will pop in loud and clear.

Now When You Hit That Mute, Others Will Listen...
They'll Have To - You Offer No Choice!

You've seen advertisements telling of the Cadillac of antennas. Well, here's the Rolls Royce of CB Antennas.

1. World's longest boom - 40 ft.
2. World's most powerful - 500 W of Effective Multiplied Power.
3. World's most directive - unbelievable.
4. World's best F/B Ratio & Side Rejection - fantastic 50 dB.
5. World's most rugged construction - special aircraft aluminum.

And the list continues on...

Ask one of the staff at Wilson Electronics what he

ELECTRICAL

Gain	18 dB
F/B Ratio	up to 50 dB
Side Rej	up to 50 dB
SWR	1.3 to 1 or less
Polarity	Horizontal or Vertical
Power	2 KW

THINKS of the Super Laser, and his answer will be "FANTASTIC!" That pretty well describes this antenna.

The unique method of gain and directivity of The Super Laser will take a normal transmitter (even though it will handle 2 KW) and produce an Effective 500 Watts of Multiplied Power.

The Super Laser has adjustable Gamma Matches to obtain the lowest SWR for Horizontal or Vertical Polarization. The boom, 40 ft., of 3" OD, with 5/8" elements of quality heavy wall aircraft aluminum, produce an assembled antenna weighing 70 lbs. with a wind survival of over 90 mph.

With this kind of strength and durability we recommend using the following with The Super Laser:

- Mast - 2" OD
- Tower - Rohm 25G, Consolidated HD-18 or Equivalent
- Rotor - Rotor Brake or Prop Pitch

MECHANICAL

Boom	40 ft. 3" OD aluminum
Elements	5/8 inch aircraft quality aluminum
Weight assembled	70 lbs.
Quad Reflector for improved Gain & F/B	
New Fiberglass Spreaders	

Wilson Electronics Corp.

NEW LONG BOOM 12 ELEMENT LASER BEAM

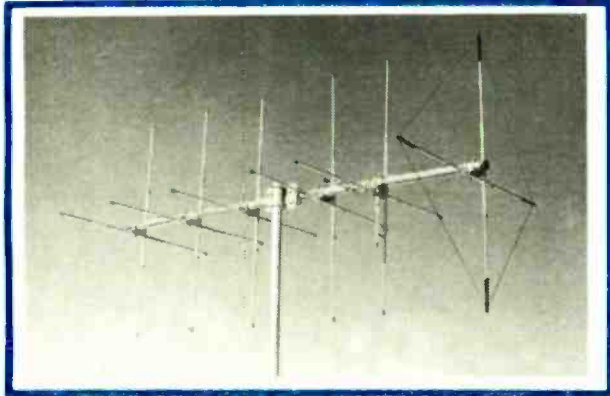

31 FT. BOOM

400 WATTS EFFECTIVE POWER

The new 12 Element Laser has been expanded to achieve the maximum forward gain and front to back ratio covering a wide range of installations. This is achieved by the unique use of a Quad Reflector and Yagi Parasitic elements. There are six elements horizontal and six elements vertical, scientifically spaced, on a new 31 ft. boom. The 12 Element Laser has been tested and proven. It is second only to the Super Laser 500. The same top quality aircraft aluminum that has made Wilson Electronics famous, is used in the new 12 Element Laser.

MECHANICAL SPECIFICATIONS

- Boom Length: 31 ft.
- Longest Element: 17.5 ft.
- Elements: Aircraft type aluminum
- Element Mounts: Aluminum extrusions
- Quad Reflector: Wire 14 GA Copper Stranded
- Boom 2" OD
- Weight: 45 lbs.
- Fiberglass spreaders
- Recommended Rotor: Ham II

ELECTRICAL SPECIFICATIONS

- Gain: 17 dB
- Front to back ratio: up to 40 dB
- Side Rejection: up to 45 dB
- Horizontal or Vertical Polarization
- Power Capability: 2,000 watts
- Adjustable Gamma Matches for Horizontal & Vertical
- SWR: 1.3:1 or less
- 400 Watts effective multiplied power

Wilson V QUAD BEAM VQ2

The Modern Successor to the Quad

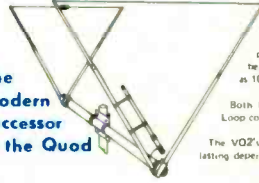

Now the Wilson VQ2 Quad offers CBers the advantages of both horizontal and vertical polarization with only one coax feed line. The new V configuration gives outstanding gain and pinpoint rejection. Experienced CBers know how annoying fading due to polarization can be. With the dual polarity of the VQ2 Quad signal fading is reduced as much as 10 dB.

Both horizontal and vertical polarization is achieved through unique V Quad Loop configuration.

The VQ2's rugged mechanical structure of top grade aluminum tubing assures long lasting dependable service. Handles up to 2,000 watts with maximum power transfer.

MECHANICAL SPECIFICATIONS

- Boom length: 6 ft.
- Elements length: 12 ft.
- Accents up to 1/8" in mast
- Wind survival: 100 mph.
- Net weight: 7.5 pounds

ELECTRICAL SPECIFICATIONS

- Gain: 10.5 dB
- F/B Ratio: 25 dB
- Side Rejection: 40 dB
- SWR: 1.3:1 or less
- Polarization Vert and Horiz
- Impedance: 50 ohms

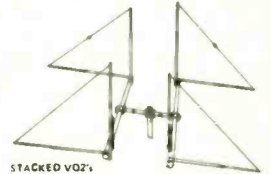

STACKED VQ2's

Stacking Kit includes Boom, Hardware and Coax Network.

Wilson "MAXIMUM" ANTENNAS

The new "Maximum" antennas are tunable from 26.5 to 30 MHz in either the horizontal or vertical position. This is possible by adjusting the element lengths to the specific frequency between 26.5 and 30 MHz.

The mechanical construction is superior to other antennas as we use extruded aluminum boom to element clamp which do not require drilling holes in the elements. All aluminum tubing is heavy wall aircraft type.

All Wilson CB Beams have the following common features:

- Taper Swaged Tubing
- Full Compression Clamps
- No Holes Drilled in Elements
- 2" or 3" Aluminum Booms
- Adjustable Gamma Match 52 Ω
- Quality Aluminum
- Handle 2kw
- Heavy Extruded Element to Boom Mounts

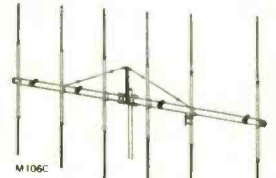

M106C

MECHANICAL	M106C	M106C	M105C	M103C
Boom Length	40"	31"	26"	11' 6"
Boom OD	2"	2"	2"	1 1/2"
No. of Elements	8	8	5	3
Longest Element	19"	19"	18"	9"
Turn Radius	24"	17"	15"	10"
Swivel Area	4 sq ft	3 sq ft	2.5 sq ft	1.5 sq ft
Wind Survival	100 mph	100 mph	100 mph	100 mph
Weight	40 lbs.	36 lbs.	24 lbs.	12 lbs.
Rotor	H.I.	H.I.	Make: T.V.	
Stacking Kit	N/A	MBSK	MBSK	VQ2SK

ELECTRICAL	M106C	M106C	M105C	M103C
Tuning (MHz)	26.5-30	26.5-30	26.5-30	26.5-30
Gain (dB)	18	17	15.5	11
Front to Back (dB)	50	31	31	25
SWR	1.5:1 or less	1.5:1 or less	1.5:1 or less	1.5:1 or less
Power Capability	2,000 watts	2,000 watts	2,000 watts	2,000 watts

Wilson HAS TOWERS!

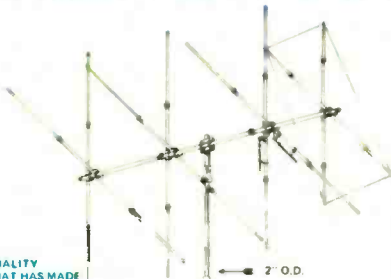

THE SAME HIGH QUALITY CRAFTSMANSHIP THAT HAS MADE WILSON ANTENNAS FAMOUS AROUND THE WORLD IS NOW AVAILABLE IN TOWERS!

CONSTRUCTED OF HIGH STRENGTH TUBING AND A HOT DIPPED GALVANIZED FINISH, THE "TT-48" WILL EASILY HANDLE THE 8 ELEMENT SHOOTING STAR OR 12 ELEMENT LASER WITH GUYS AT 48 FT. ALTHOUGH THE "TT-48" IS NOT RECOMMENDED FOR THE SUPER LASER 500, IT CAN HANDLE THE 12 ELEMENT LASER OR SHOOTING STAR WITH OUT GUYS AT 40 FT. THE "TT-48" WILL HANDLE 9 SQ. FT. OF ANTENNA IN 50 MILE WINDS AT 40 FT. WITH NO GUYS AND STILL HAVE AN ADEQUATE MARGIN OF SAFETY.

SHOWN WITH 8 ELEMENT SHOOTING STAR

2" O.D.

ELIMINATE THE PROBLEM OF STORAGE AND SPACE AS INCURRED WITH TRIANGULAR BASE TOWERS. CRANKED DOWN TO 21 FT. AND ONLY 4 1/2 INCHES WIDE THE "TREE TOP 48" CAN BE STORED OR MOUNTED ALMOST ANYWHERE.

BUILT FOR THE ECOLOGY MINDED.

3 1/2" O.D.

TOTAL INSTALLATION TIME ONLY 1/2 HOUR.

4 1/2" O.D.

COMES COMPLETE WITH FLAT HINGED BASE, WALL OR EAVE BRACKET, ANCHOR BOLTS, RAISING WINCH AND CABLE.

1/8" 2,000 LB TEST, GALVANIZED AIRCRAFT CABLE

RECOMMENDED ROTOR HAM II OR CD44

800 LB. CAPACITY WINCH

TOTAL SHIPPING WEIGHT 170 LBS.

REQUIRES ONLY ONE CUBIC FT. OF CONCRETE AS A BASE

TT-48



THEY DON'T WORK

Without Antennas

SEE OURS ON DISPLAY AT YOUR FAVORITE DEALER

OR WRITE

Wilson Electronics Corporation



4288 S. POLARIS AVENUE LAS VEGAS, NV 89103
(702) 739-1931 or TELEX 684-522

Circle 94 on reader service card

CB Antennas for Your Car



Mobile CB antennas are available in a variety of shapes, sizes and types. This combined with a wide choice of mounting locations and hardware makes finding the best possible combination difficult

HERB FRIEDMAN

IF YOU WALK DOWN TO YOUR LOCAL CB DEALER YOU MIGHT FIND A handful of antenna models from perhaps two, maybe three manufacturers. If you walk past to another dealer you'll find a completely different selection of antennas from a different group of manufacturers. And if you went to five different CB shops it's quite likely you would never see the same antenna or manufacturer twice. It seems that every week or so a new manufacturer joins the ranks of those providing antennas and in many instances they each offer something slightly different—and if not a different antenna, at least a different mount.

At one time selecting a CB antenna took about 30 seconds of thought. You had your choice of a full length 108" whip that was bumper or body mounted for mobile, and a ground plane or coaxial antenna for the base. About the only real choice you had was between manufacturers, most of whom were primarily concerned with the amateur/commercial market. And you could select between the antennas of maybe three or four brands, all virtually identical except for the brand name.

Today, the CB antenna is king of the hill. The demand is so great that most new brands simply avoid the amateur and commercial users, and many of the old-line manufacturers now have an extensive line of CB antennas with their other services relegated to a page or two in their catalog.

The duplication is, of course, enormous. You can find five or more models of the same type of mobile antenna within a

short walk down any city's "electronics row". On the other hand, you will also find just about any oddball mount or design you or anyone else can dream up. No matter how far-out your particular mobile mounting problem might appear there's an odds-on bet someone has already thought of it and sells a specific mount (with or without antenna) virtually tailor-made for your particular mobile installation.

And when it comes to base station antennas . . . ho boy! You name it and someone makes it. Everything from an inexpensive ground plane that gets you into CB on a tight budget, to a virtual *RF cannon* that concentrates a transceiver's RF energy into one direction so the signal equals that of a transmitter with about 250 watts RF output.

There are basically four types of mobile antennas, which through various specialized designs and mounting brackets finalize into some 50-odd different antennas. First, there are the 102-inch whips designed to be used with 6-inch shock-

THE TWIN-GUTTER MOUNT requires phasing harness and provides a directional response that points directly in front and behind car.

CENTER-ROOF MOUNT (left) provides the best omnidirectional response. This location requires a magnetic mount or a hole cut into the roof. **BUMPER MOUNT** (bottom) does not provide optimum directional response but antenna attaches directly to bumper.

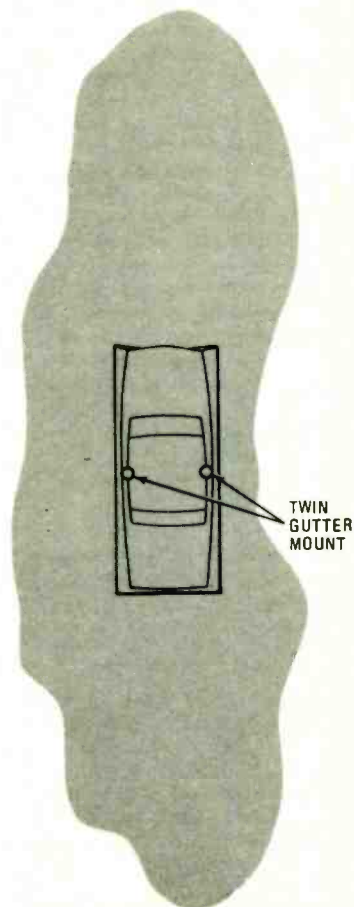
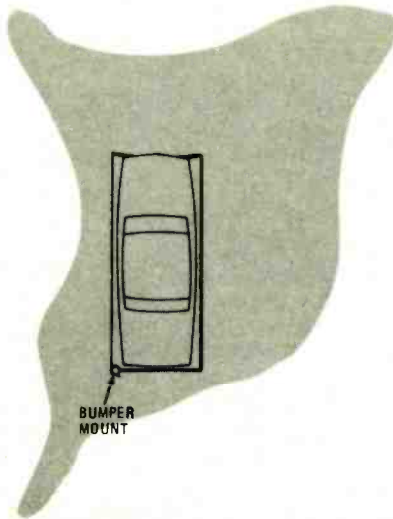
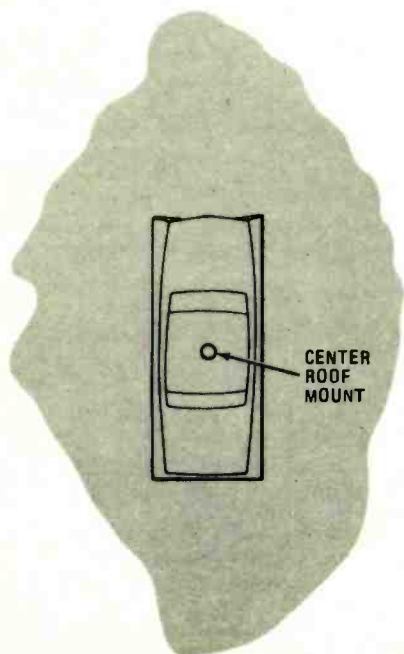

springs for a total length of 108-inches—the so-called $\frac{1}{4}$ -wavelength whip. There are also some 108" whips that are meant to be used without shock-springs, if you're crazy enough to do it. Most 108-inch whips are stainless steel, a few models such as the Breaker 12-505, Shakespeare 10-3 and Cushcraft CB-9 are fiberglass, which is generally preferred around salt water. If you're interested in fiberglass whips don't be touted off by their 96-inch length. The fiberglass covering alters the velocity factor of the conductor so an electrical $\frac{1}{4}$ -wavelength is attained with only 96 inches overall.

The second type of mobile antenna is the group consisting of fiberglass continuously loaded, or top loaded, whips. The overall length of these models is generally in the range of 36 to 48 inches, and they are usually non-adjustable. You screw them into the mount and the SWR is whatever it is. The advantage of the continuously loaded and top loaded whips is that they normally have a slightly greater "output" than center or base-loaded antennas of equivalent size. The reason for the greater output is that $\frac{1}{4}$ -wavelength antennas radiate primarily from the high-current area which is near the base, minimal current is at the top of the antenna. If the antenna is top or continuously-loaded—the high-current area is undis-

turbed by the loading system. As the loading is moved downward through a center or base loading coil, the high-current area is compressed towards the base of the antenna, providing less high-current area for radiation.

So why doesn't everyone use top or continuously loaded antennas? Because they are top-heavy, present high wind loading, and have a narrow bandwidth that presents tuning (high SWR) problems in certain installations. But when they can be used they have a definite advantage of greater radiation. Among the many manufacturers that provide top and continuously loaded antennas are Antenna Specialists, Mark, Shakespeare, Cushcraft, and Newtronics.

The real kings-of-the-road are the center and base-loaded mobile whips, for there are more of them on the road and in the CB showrooms than there are any other type of antenna. The reason for their popularity other than the fact they are cheap to manufacture and even cheaper to blister package is they are the easiest to adjust for individual mounting conditions. Connect an SWR meter in the transmission line, slide the top whip section up and down until you have lowest SWR, tighten a set-screw and the antenna is optimized to the car, truck, camper, etc. Maybe the radiation isn't as good as from a

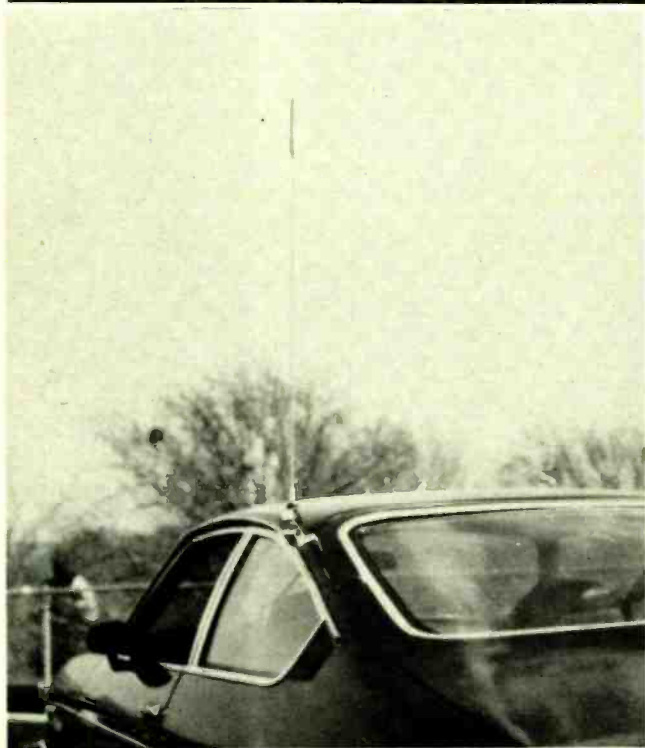

TWO VIEWS OF A CB ANTENNA (above) with a unique hatchback mount that lets the user adjust the position of the antenna. The user can set the antenna so it stands straight up vertically on hatchback and fastback cars. In addition to the adjustment feature, the antenna doubles as a trunk-groove mount. It's made by Antenna Specialists. The new mount also makes it possible for the CBER to remove his antenna easily when he parks to protect against vandals and thieves.



A WATERPROOF ANTENNA MOUNT (left) also made by Antenna Specialists is worth noting. It provides complete protection against water shorting the antenna.

top-loaded or full-length whip, but a better "match" through an optimized tuning for a particular installation can result in a stronger signal at the receiving station.

Center- and base-loaded antennas come in every size from about 18 inches up; and here the rule is firm—the longer the antenna the greater the radiation. You should use the longest model you can get away with, short of breaking the lights at the next toll booth.

Every antenna line contains several different base and/or center-loaded mobile antennas, even the brands you might not of heard of yet, such as Shark, Antenna Inc. and Teaberry. (Keep in mind that yesterday's "unknown" brand is tomorrow's national brand when it comes to CB equipment.)

The only real difference between mobile antennas of similar design is the overall construction. Some models, such as the Avanti base-loaded models, will probably outlast five cars. Then there are the models from Antenna Specialists and Hy-Gain with loading coils that coast at 250 or 500 watts input, though this is somewhat more power than allowed by the FCC—like 246 and 496 watts too much.

The fourth and final type of mobile antenna is the *dual*

antenna system sometimes termed *co-phased, twin, or Fazer*. The dual antenna system consists of two mobile antennas of any type connected through a phasing harness so the radiation pattern compensates for a poor mounting location. For example, if a whip were mounted on a truck's mirror bracket (the most common location), the radiation pattern would favor a diagonal line running through the truck. By mounting a whip on each side of the truck, connected by a common phasing harness (transmission line), the radiation pattern is shifted straight back and down the road. (Actually, the signal is made more omnidirectional, but since a greater part of the energy is forward and back it has become common to claim the dual antenna system concentrates the radiation "down the road.")

Within the four classifications of mobile types there are some six or seven basic designs—depending on what could be considered a different design. It is when we connect the pieces of mounting hardware that we get so many different antenna models. For example, put any type of antenna on a mirror bracket and it becomes a "West Coast Mirror" antenna. Use two West Coast Mirror antennas, add a phasing harness and you get a "trucker's antenna"—and just about everyone makes

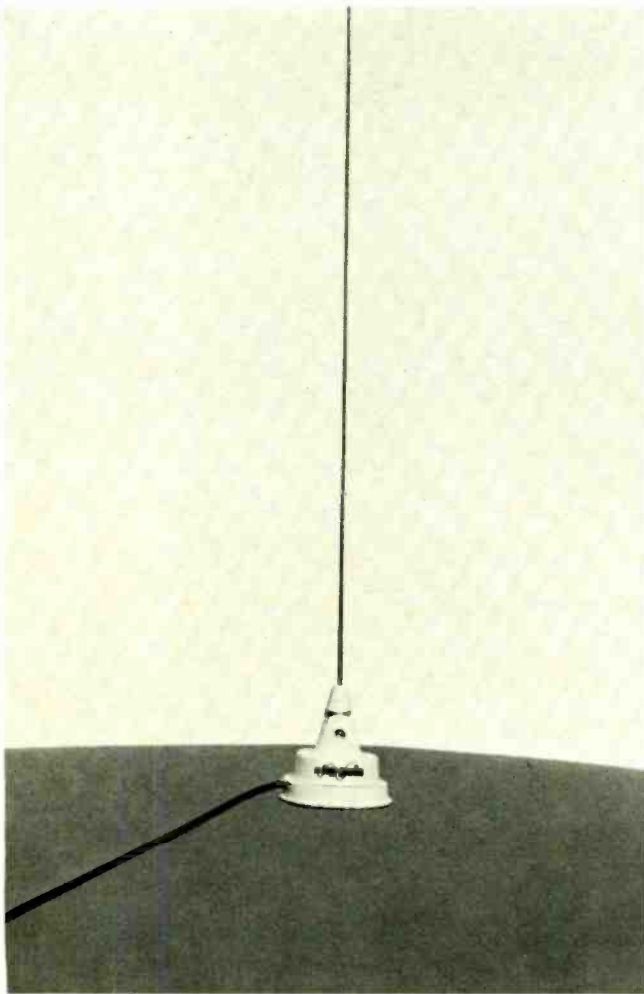

MAGNETIC ROOF MOUNT by Hy-Gain (above) is a cinch to install and remove. It has a 48-inch whip and the magnet is covered with a layer of clear plastic to protect the car roof against scratches.

THE BUMPER MOUNTED CO-PHASED WHIP combo (top right) is made by Shakespeare. It features two half-wave center loaded antennas with a Diplexing wiring harness.

AT THE RIGHT IS Antenna Inc.'s spring clamp gutter mount antenna. It has a stainless-steel whip.

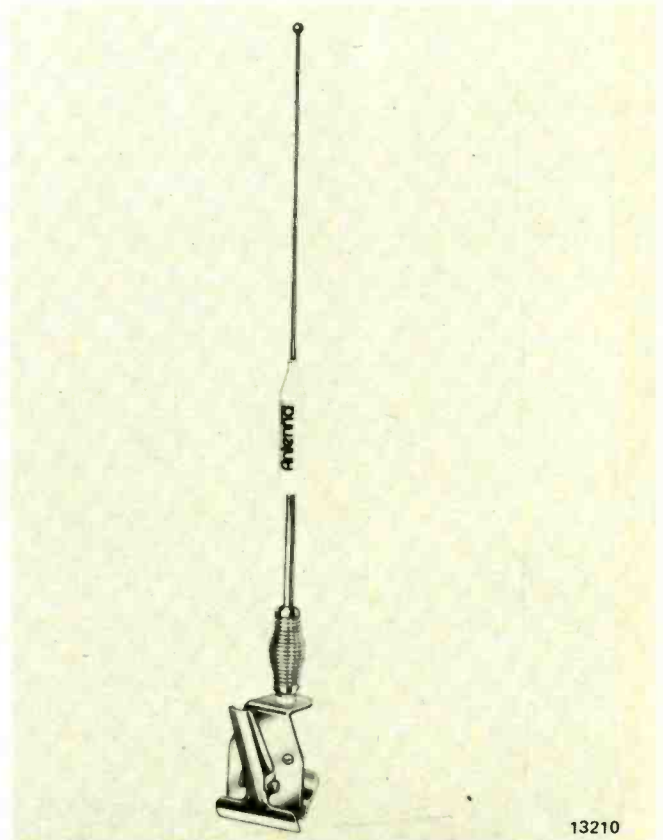

13210

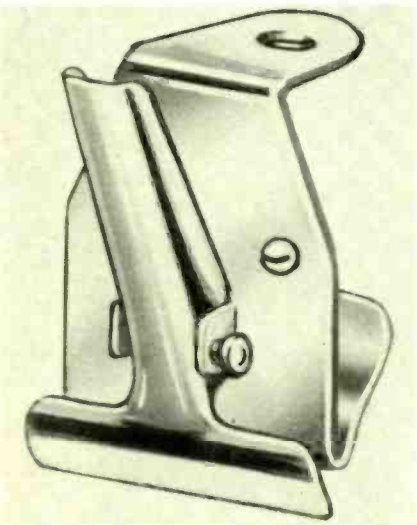
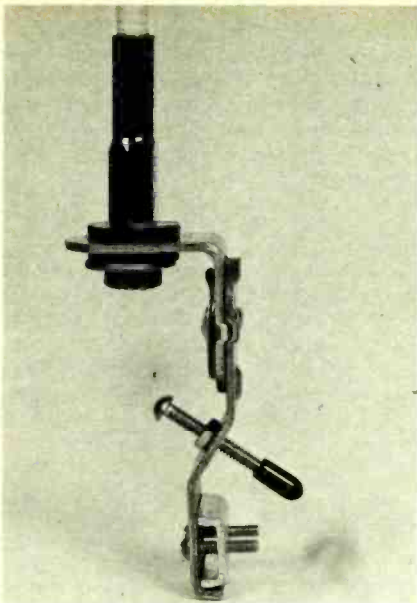

GUTTER-MOUNT ANTENNA (top) has a fold-over mount. It's made by Hy-Gain. **THE SPRING CLAMP** gutter mount (above) is made by Antenna, Inc. It adjusts to the car's rain gutter and needs no screws.

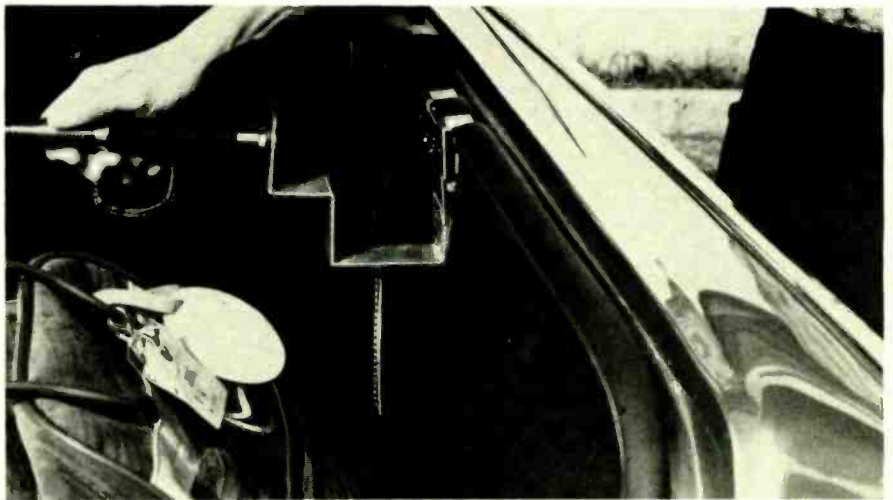
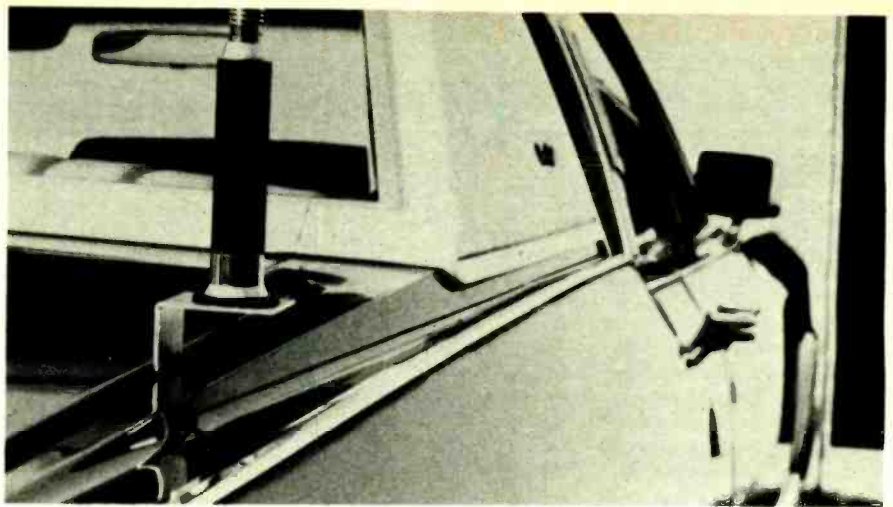

TUK-A-WAY ANTENNA MOUNT (top) is shown in use. Made of cold rolled steel and coated in zinc chromate it attaches to the trunk rim of most cars. It's made by Deep South Marketing Corp.

WHEN NOT IN USE (above) the Tuk-A-Way antenna mount folds into the trunk. When it is folded down, a stop keeps the antenna suspended and off the trunk floor while it is stored. Only the mount is supplied. The mount accepts antennas designed for either roof or trunk mounting.

one of those. Do you change trucks often, moving the rig each time? Then you can even get a set of vise-grip clamps with a built-on antenna mount you can quickly attach and remove it from any truck mirror assembly.

If you have just a typical mobile installation the choice of antennas and mounts is almost endless. There are mounts that go through the car (in a small hole), mounts that wrap around the edge of the trunk lip for a no-hole installation, mounts that fit the trunk-lip rain channel, mounts that fit on the bumper, mounts that clip to the rain gutter over the driver's window (either permanently with screws or temporarily with a clamp), even a magnetic mount that can hold a mobile whip in the center of the roof at high speeds. If there's some possible way to install a mobile antenna someone makes the right mount.

When we move from the concrete to the water, things get a bit more difficult as the antennas must be water and corrosion proof. While stainless steel will resist salt water corrosion, it depends on the type of stainless, and there are some stainless steels which virtually dissolve when out on the ocean. There's no way you can really be certain what you're getting. Fact is, the best marine material is usually fiberglass and that's what

you'll find in the marine lines from the best known manufacturers such as Antenna Specialists, Hy-Gain, Francis, Mark and Shakespeare. These outfits have a lot of experience with marine equipment, and even those with stainless steel antennas use a formulation that's specially made for marine service. Each also provides special corrosion and waterproof marine mounts (such as a fold-down or lay-down bracket). Also, special marine antennas are available which do not require a ground plate connection, such as the A/S M-306, Francis CB-74, Mark HW-11-M6, and Shakespeare 176-1, among others. While the longer marine antennas such as the 8-foot Hy-Gain 433 are too tall for mounting on top of a camper, the shorter no-ground marine antennas can be used on non-metallic campers and other RV's. (Normally, a "standard" whip performs poorly on a non-metallic vehicle because there's no ground plane. No-ground marine antennas are specifically designed to work without a ground plane, whether on water or land. A standard mobile-type antenna would require a connection to a boat's ground-plate.)

Buying the right CB antenna isn't easy, but it can't be done casually either. We hope we've shown you the basics you need to make a wise choice.

R-E

DIGITAL CLOCK KIT ROUNDUP

PART II. A comparison between the various digital clock kits that are currently available

FRED BLECHMAN



ALTAJ 4-DIGIT ALARM CLOCK parts layout. Includes a case, not shown.



REAR VIEW, ALTAJ 4-DIGIT. Radio switch powers external radio for 45 minutes.

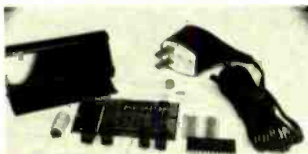

PARTS LAYOUT, Babylon Space Age clock.

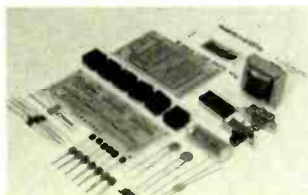

SABTRONICS, parts layout.



BACK-PANEL VIEW OF THE DDC-1.

THE FIRST PART OF THIS ARTICLE DISCUSSED THE FEATURES AND PRESENTED A comparison chart of the clocks that are presently available. This second part of the article will take an in-depth look at each of the clock kits in alphabetical order.

Altaj Electronics

Both of the Altaj clock kits specify the use of "Molex pins", which they don't include. Molex pins substitute for IC sockets. They are spring-pins that are made in strips with the standard IC pin spacing of 0.1 inch. They are joined together at the top by a common flat metal section. You merely snip a length of strip that has the number of pins you want, with the connecting top section intact, insert them into the circuit board, and solder them to the foil. Now that the pins are secured by the solder joint, you bend the top connecting section back and forth with pliers until it breaks off, leaving the individual spring contacts all in a row, ready to accept the pins of the IC. Molex pins are somewhat hard to find, but suppliers heavy in the IC area have them. (James Electronics has them for \$1 per strip of 100). Since clock IC's are subject to destruction in soldering and handling, Molex pins or IC sockets are used in most of the kits. Also, if you have a bad IC and want to unsolder it from the circuit board, you've got a real problem—some of the IC's have 40 pins to unsolder all at once!

The direct-drive 4-Digit Alarm Clock offers a sleep switch to shut off an external radio after 45 minutes. The digits for this clock can be ordered in either 0.25 or 0.5-inch heights.

The King is the most versatile of all the kits with respect to options. You can order 0.3-inch high red, yellow or green digits, or red digits 0.5 inch or 0.6 inch high. Extra modules are being offered to read temperature in four digits, to start an external appliance at a specified time, and to chime on the hour electronically! This clock is difficult to handle during final assembly, since the spacing and positioning of the display within the case involves connecting the control board and display board with 2-watt resistors that feed the display segments and double as structural members. The cases for both of these clocks are "first class"!

Babylon Electronics

The Space Age Clock Kit is the smallest and certainly the "cutest" of all the clocks reported in this article. It also got the most attention at a display of eight of these clocks at a recent Clock Society meeting. It somehow manages to use fewer parts than any other MM5314 clock, yet works beautifully. The kit is very complete, even including Molex pins and wire for the three "jumpers". Only solder was omitted.

To conserve case space, the transformer is a wall-plug type, and the switches for setting time are constructed and pre-assembled right on the printed circuit board. You simply apply pressure with a pencil point through the three holes in the back of the case for fast, slow and hold! The coded pulsing colon described earlier allows precise time setting to the second, even though only four digits are displayed. Soldering is somewhat difficult, since many of the circuit paths on the PC board are very close together, and the pin spacing of the FND-70

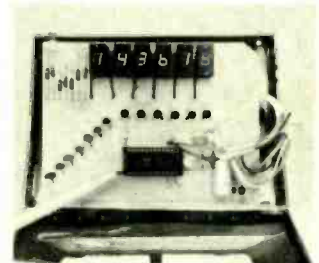

GODBOUT-SON-OF-A-CHEAP-CLOCK.

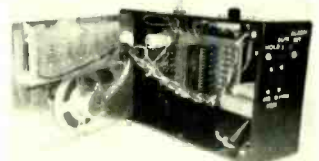

S.D. ALARM CLOCK. Display and alarm are on front panel and can be mounted remotely.



THE HEATHKIT MODEL GC-1092.

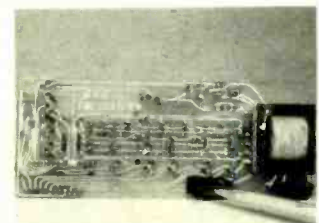

JE-700 TIMESETTING SWITCHES are prefabricated right on the board.

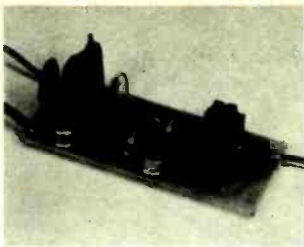

THE BILL GODBOUT TIME BASE.



TWO MV-50 LED's between hour and minute displays form a pulsating colon that reads seconds in Space Age clock.

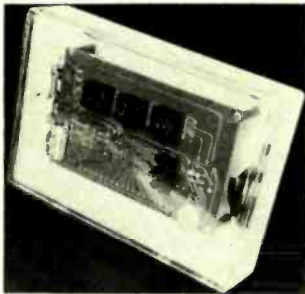

THE INTERNATIONAL CLOCK in a plastic box.

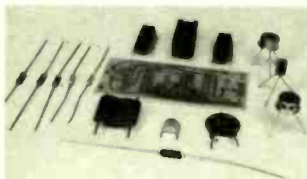

GODBOUT TIMEBASE PARTS LAYOUT

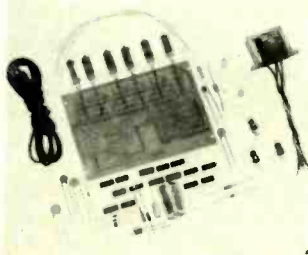

A PROFESSIONAL TYPE CLOCK, THE ESE ES-112K USES 15 separate IC'S instead of one clock IC, to achieve its results.

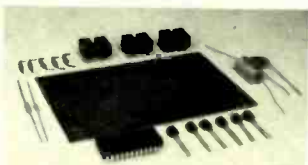

INTERNATIONAL ELECTRONICS CLOCK parts layout. Requires a 12-volt transformer.



BLACK WATCH reads hours and minutes or date or seconds by pressing front panel.

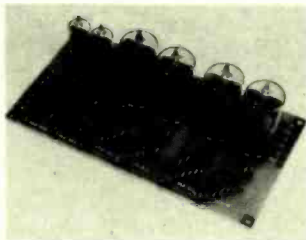

THE CARINGELLA DDC-1 DISPLAY uses RCA Numitron tubes in sockets.



PARTS LAYOUT, JAMES JE-700.

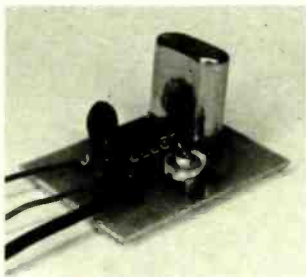

S.D. SALES TIME BASE gives you the correct time from 12 volts DC.

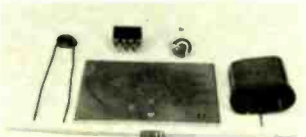

S.D. timebase, parts layout

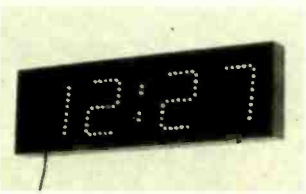

JAMES GIANT WALL CLOCK uses 31 separate, LED's to light each digit.

displays are close. But, with care and a jeweler's loupe to inspect your work, you'll end up with a clock sure to get attention.

Bill Godbout Electronics

This is the only kit reported on that includes sockets for all the displays and the IC. You can make this clock with remote readouts, digit-blanking (display off to conserve power during battery use), 12 or 24-hour display, and battery or 50- or 60-Hz operation. Actually, any of the MM5314 clocks can do all these things, but the PC board and the instructions in this kit provide the method in detail. The PC board is designed so you can literally saw off the display portion and put it on your dashboard, for example, connected by a 13-wire ribbon cable to the clock control board under the dash. Specific instructions and sketches are provided to do this. Using a timebase described earlier, you can have a "Cheap Car Clock" (Godbout offers combination clock and timebase kit for \$23.50).

Caringella

Beautifully packaged, and with clear, detailed instructions, these clocks would be rated "easy" in assembly, except for the large number of parts. No shortcuts have been taken, and these are top-quality clocks in appearance and performance. Great pains have obviously been taken to see that the builder has a no-hassle assembly job. Every wire needed in the assembly is color-coded by length, with the ends stripped of insulation and tinned for easy handling and soldering. If several wires follow a common path, they are furnished in pre-assembled tied cables, with each wire color-coded! This kit was really a delight to assemble, especially after some of the head-scratching required with other kits that offered not much more than a box of parts and a poorly reproduced schematic. Caringella kits show great attention to detail, in both the design of the kit and the clarity of instructions. The printed circuit boards were silk-screened on the component side to show the location of every part, making assembly almost foolproof.

Several Caringella clocks deserve special mention for unique design. The DDC-1 uses large digits for the hours and minutes, smaller ones for the seconds, making the display easier to interpret. This is also true with the DWC-1 and the MDC-1. The DWC-1 is a huge wall clock, with digits formed from individual LED's placed in lines to create digit segments. Furthermore, this clock and the MDC-1 have crystal-controlled built-in battery-powered timebases; this allows them to be unplugged, carried to another location, and when plugged in again with the displayed time being "right on". This also provides power failure immunity. The LDC-1, and smaller SDC-1, use only a single digit to read hours and minutes. The digit first reads tens-of-hours, then units-of-hours, then tens-of-minutes, then units-of-minutes—and then pauses before repeating! The LDC-1, in its 7-inch high hexagon wood case and single 3 1/2 inch high digit, is a rare decorator conversation piece!

Fig. 2 shows the DDC-1 schematic—an MM5314 IC design with NO shortcuts!

Digital concepts

The EC-2000K takes less than a half hour to build, since there are very few parts. The display is a single large planar fluorescent display module that contains four large digits, colon, and AM and PM letters. Standard coloring is bright blue, but you can order other colors—they simply paint the front of the module the color you request, since the fluorescent output covers a broad spectrum of colors. All parts, including the transformer, mount directly on one printed circuit board. The only external wiring is the line cord and the wires to the time-setting switches. One switch selects unit-minutes and seconds display, instead of hours and minutes, and by proper operation of the switches this clock can be used as a 24-hour stop-clock that counts by the second! The case is unique in its clear tubular shape, with end-blocks in decorator wood. The end blocks have annular grooves that fit over the ends of the cylinder—no unsightly screws.

The CK-131 is a calendar clock—that is, it will read month and day alternately with time, if desired. With a clear Lucite front panel the display is orange and the circuit board parts show. With a colored panel, the display appears red, and the parts are not visible.

ESE

Instead of using a clock IC, this kit uses 15 individual IC's to perform the various functions of wave-shaping, dividing, decoding, encoding and driving the displays. This is a professional piece of equipment used extensively in the broadcasting industry, and is not really aimed at the hobby market. Assembly is straightforward, with very few parts beside the IC's. It comes in an attractive, rugged case and uses large, bright readouts with simple time-setting switches.

Formula International

The MM5314 clock is actually a simple kit to build, but the instructions are poorly planned and poorly reproduced, making a simple job confusing. With better instructions, this would be a very good "first clock kit" since the kit is very complete (only lacking solder and switch wiring). The circuit board is silk-screened to show component location and the only "tricky" part of the assembly is putting the eleven wire leads on each of the six fluorescent tube displays into the PC board. The case is modern and attractive, and the display a pleasant blue-green.

The OC130 and OC1032 are also very attractive when complete, but assembly of these two kits had best not be your first entry into the field. The OC1032 in particular is difficult to assemble, with the display sandwiched between two large circuit boards connected together with "strong copper wires". Although the OC1032 has only four digits, they are 1 inch high, and can be switched to read minutes and seconds. The digits are a bright yellow-orange, and the case is outstanding in appearance.

Heath

In the forefront of new design, these kits were produced before many of the other clocks shown, yet contain almost every imaginable feature—except simplicity! The designs are complex, with a maze of parts and cabling making them the most time-consuming clocks to build of all those in this article. The superb manuals would allow even a beginner to build one of these clocks given the time—a lot of time. However, if something goes wrong, it would take a competent technician to unravel it!

The GC1092A and GC1092D look alike—they use a similar case—but the "A" is an alarm version, and the "D" is a calendar clock. For power-failure operation, both use a battery-powered timebase oscillator whose output is calibrated by zero-beating against the line frequency as a time standard. The GC1093 is the only clock designed for car use, and uses a crystal-controlled timebase for accuracy. It also features switch-selection of elapsed time, repeating every 20 minutes. This would be a handy feature for sports car rallies.

International Electronics

The two-sided printed circuit board, with plated-through holes, makes assembly of this kit a breeze. This is a "bare-bones" kit, containing all the necessary electronic parts, but without transformer, wire, switches, solder, case or sockets, so you'll have to do some additional shopping or junk-box raiding to end up with a usable clock. The PC board is designed with solder pads to connect wiring for remote readouts, and the instructions designate the outputs. For some unexplained reason, the PC board and remote connections will accommodate 9 digits, although only six are used. This is the least expensive kit on our list, even though it offers six digits at a lower price than some four-digit kits. With a two-buck transformer you probably have around (regular 12-volt type), three simple SPST or pushbutton switches and a plastic case, you're in business!

James Electronics

Appearing at first to be a very simple kit and containing everything you need but solder—even a neat wooden case and red plexiglass front panel—the JE-700 turns out to be a tedious assembly job because of 29 jumpers (wire connections) on the component side of the PC board. Assembly is not difficult—just slow. Time is set by pushing a pencil through holes in the back of the case to press on PC board switches (similar to Babylon). However, the HOLD switch is not provided to synchronize the seconds! This can be easily added by providing a switch to ground from pin 13 of the IC—but no mention of this appears in the instructions. Speaking of the instructions, they look nice enough but contain a number of errors sure to confuse a beginner.

The Wall Clock uses 0.6 inch high readouts for hours and minutes and 0.3 inch high readouts for seconds. Only three jumpers are used, so assembly is straightforward, if you can follow the instructions.

The most recent additions to the James clock-kits are the giant-digit wall clocks. Thirty-one separate LED's are used to form the seven segments of each digit, with additional LED's used to form colons between pairs of digits. Construction is not difficult, but takes time because of the large number of LED's used and because four jumpers are used with most of the digits. The 4 and 6-digit versions of this kit are identical for the first four digits with an add-on board containing the fifth and sixth digits. The assembly instructions are sparse, but a good pictorial makes them adequate. Time setting is simple using switches built-on to the PC board, just like the JE-700—except that a HOLD switch is included to stop the seconds count. The finished unit, complete in wooden case, is a sight to see!



S.D. ALARM CLOCK, mounted by the author in a standard plastic box.

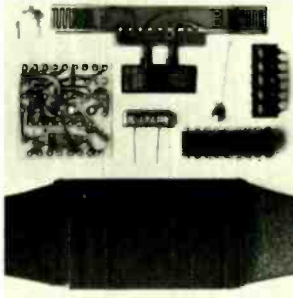

BLACK WATCH KIT, parts layout.



THE FLUORESCENT TUBE DISPLAY of the Formula International MM5314.



THE DIGITAL CONCEPTS CK-131. If a colored panel is used, the components are not visible.



JAMES JE-700 CLOCK

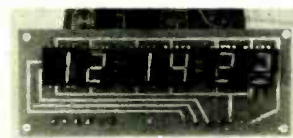

QUEST HAS LARGE DIGITS.

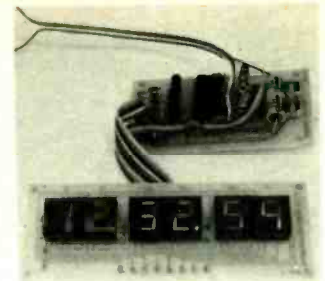

SABTRONICS uses decimal points for colons; connects sub-assemblies with ribbon cable.



NOVUS CONTROL PANEL is concealed.



SINCLAIR KIT is beautifully packaged.



SINCLAIR BLACK WATCH is the first kit for a digital wrist watch.



STEP-BY-STEP CONSTRUCTION of an electronic calendar clock. The Digital Concepts CK-131 is well shown in this layout-plus-demonstration.

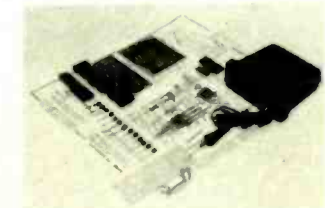

NEXUS CAR CLOCK, parts layout.



THE NEXUS OUT OF ITS CASE.

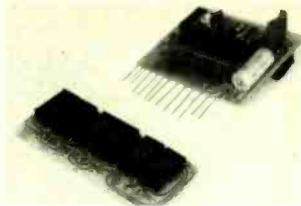

SUB-ASSEMBLIES for the Nexus car clock connect together with resistor leads.

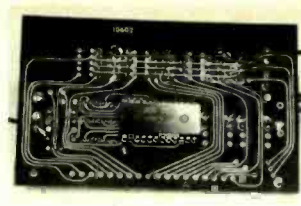

MM5314 IS ON ONE SIDE OF PC BOARD, clock display is mounted on the other.

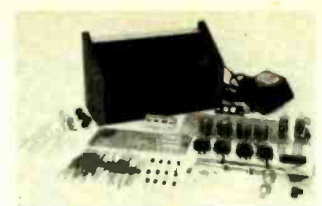

PARTS LAYOUT FOR THE DDC-1.

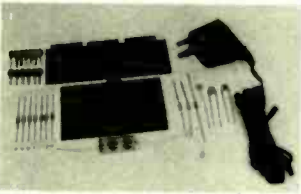

THE QUEST PARTS LAYOUT. The transformer is at the plug end of the line cord.

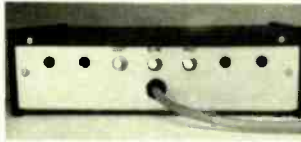

REAR VIEW OF THE ESE ES-112K. The three adjustments simplify time setting.

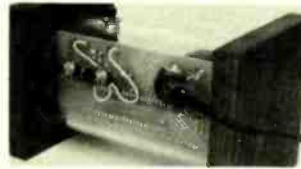

EC-2000K, ANOTHER REAR VIEW.

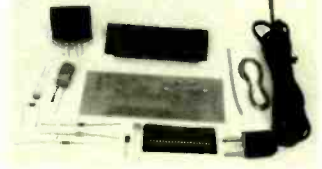

PARTS LAYOUT OF THE EC-2000K.

Meshna

The SP-169 clock kit is unusual in several respects: The PC board is 4 x 6 inches, rather large, but so designed that it is in four separate sections that can be cut apart. The case is a surplus extension TV speaker cabinet that includes a speaker and volume control, and a provision is made for either AC or battery operation. The four sections of the PC board, when cut apart, are the same size and are designed to allow stacking, like a club sandwich. All the necessary parts (except line cord) are provided for AC operation, but detailed instructions, PC board section and a parts list provide the timebase option with any crystal up to 6 MHz that can be divided down to 50 or 60 Hz evenly. The instructions are not elaborate, but include a good pictorial parts layout and schematic. Since the case was not made especially for this kit, final assembly required some cutting and drilling of holes.

The SP-284 *Cheap Clock* is one of the easiest of all the kits to build, and the only kit reported on to use the National Semiconductor MM5316 Alarm Clock IC. This is a direct-drive IC, and no transistors or resistors are used to operate the display. The IC has the capability for alarm, snooze and "sleep switch" and the instructions show how they can be added to the basic kit. This is also true of the AM/PM indicators. The display consists of four bright blue-green fluorescent glass tubes with high visibility even in bright surroundings. One of the three switches supplied with the kit "shifts" the display to read unit-minutes and seconds for precise time-setting. With slide switches used in place of the pushbutton switches provided, this could be used as a 24-hour stopclock that counts by the second. Although no case is provided, the kit easily mounts in a flat plastic case with the switches and the four fluorescent tubes projecting through the top lid!

Nexus

These kits were designed specifically for automotive use, and are the same design except for case and display size. They contain a crystal-controlled timebase for operation from 12 volts. The displays are bright and clear, due to high current flowing through the LEDs. The IC heats up, but is operated within limits. Time-setting is ingenious—a straight pin is inserted through a sandwich made up of the PC board, non-conducting sponge, and conducting foam pads to act as a switch. Although only fast and slow settings are provided, you can set these clocks almost to the second without the need of a third switch. Since the accuracy is inherently less than perfect (within 9 seconds per day in constant ambient temperature), second-setting is not necessary. The parts layout, case design and interboard wiring between control board and display board show good planning and execution. The *Car Clock* is the smallest 6-digit clock on our listing, and is easily located and installed in a car. The *Van Clock* is intended to be mounted in the wall of the living-quarters of the vehicle.

Quest

Step-by-step instructions, a complete schematic and a detailed pictorial view make this a simple clock to build. If not for the connections between the control and display board, construction would be listed as "Easy". The digits are large and bright, and the transformer is mounted in a wall-plus/line cord furnished as part of the kit. Switches are not included, to allow the user the flexibility of

using his own type. Display blanking is described in the instructions if you should want to remove the display board. The PC boards in this kit are two-sided, with circuit wires spaced for easy soldering.

Sabtronics

Although very similar in appearance and circuitry to the Quest Digital Clock Kit, there are some definite differences. This clock kit includes three switches (two momentary, one on-off) and a separate transformer, but no line cord. The display can be wired to show a decimal point between pairs of digits, to simulate a colon, by adding only one resistor. The assembly is simple, but connections between control and display boards move it into the "Medium" assembly rating. The display is not very bright, since the 270-ohm segment resistors limit the LED current. Changing these to 100-ohm resistors yields a very bright display and does not overdrive the IC. A smaller display, using 0.25-inch high digits, is available for \$5 less than the price shown for the 0.5-inch digits. Since the display board is completely separate from the control board, connected by 14 wires (13 for digits, 1 for decimal points), you can easily remove this board by using "ribbon cable". This cable, available from James Electronics, (26-gage, 20-conductor—59¢ per foot) is a flat ribbon of parallel adjacent wires, each in a different colored insulation; you simply fan out the ends to form individual wires, each a different color.

S.D. Sales

Patience and a good supply of stranded wire are needed to build this two-part clock kit. However, the result is a really nicely-operating 6-digit alarm clock, at the lowest price on our list. The display PC board is entirely separate from the control board, so it's a natural for a remote display. Fourteen wires join the display board to the control board—six for digit control, seven for segment control, and one to control the LED used as a PM indicator. Colons are not furnished, but the instructions cover their installation as an option. Four slide switches are used for setting time and alarm functions, with a pushbutton switch used for snooze. The Hewlett-Packard LED displays are bright and sharp. With the S.D. *Timebase* that sells for \$5.95, this would make a good electronic alarm clock for a camper or trailer.

Sinclair

Although not a clock, but a four-function wristwatch, the *Black Watch* is an electronic timepiece in kit form, so it's included in this survey. Everything—even very fine diameter solder—is included, and the PC board has the very small IC already assembled to it. The actual assembly time is short, but varnish is used at two steps in the assembly procedure to protect the circuit from environmental attack—and it takes four hours for the varnish to dry! Also, calibration can take weeks if you're a fanatic, since it's a hit-and-miss proposition of comparing watch time to real time over a period of days and adjusting the crystal-oscillator trimmer to compensate for a fast or slow condition. There is very little soldering, and no watchmaker's tools are needed (though the jeweler's loupe is very handy to check those solder joints!). The result is a unique experience and a great conversation piece—after all, how many people do you know who've built their own electronic wristwatch?

R-E

MINDPOWER: ALPHA

Part III. Build this biofeedback device that displays the presence of alpha waves on a TV screen. You can use it to learn and gain from the benefit of the relaxation that comes with it

NOTE

Mindpower: Alpha is an intriguing device for entertainment and experimentation in video biofeedback. It is not a therapeutic instrument, neither is it suggested as a cure for individuals suffering from psychological or physiological disorders.

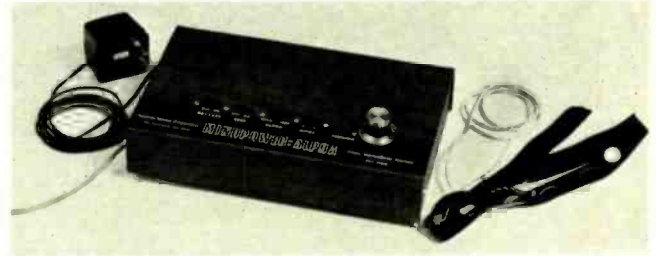

THE POWERS OF THE HUMAN MIND RANK AT THE very top of the list of unknowns being studied by scientists throughout the world today. In no small way, this activity has resulted from the discovery that the powers and capabilities of the brain are chiefly limited by the amount and quality of information that reaches it through our senses. With the discovery of *biofeedback*, it has become possible for us to use an instrument to detect the brain's activity, and to feed this information back to the brain through the senses. This fascinating discovery has opened great new possibilities for expanding the powers of the mind through biofeedback training.

Mindpower: Alpha is an entirely new type of biofeedback instrument. It is designed to serve as a link between your *mind* and a *visible, controllable display on your television set's screen*. Its purpose is to aid you in training your mind to "downshift" from the high-tension state of anxiety and stress, to the state of relaxation in which the brain produces a dominant alphawave rhythm. This state, the subject of intense interest among meditators, yogis, mind control groups, and researchers, is believed to be both beneficial to the body and an important step in expanding the creative consciousness. Once you have achieved it, you will find it a fascinating state, in which you are free to experiment with the powers of your own mind!

In the July and August issues of *Radio-Electronics*, we described how Mindpower: Alpha works. This month we will discuss the assembly details.

Assembly

The two-sided printed-circuit board (see parts list) speeds up assembly and ensures freedom from poor joints and stray coupling. The foil patterns of the PC board is shown in Figs. 1 and 2.

Begin construction by installing IC sockets on the board. To save space, 16-pin sockets are used to hold pairs of closely related 8-pin IC's in several instances. Figure 3 shows the parts layout of the board.

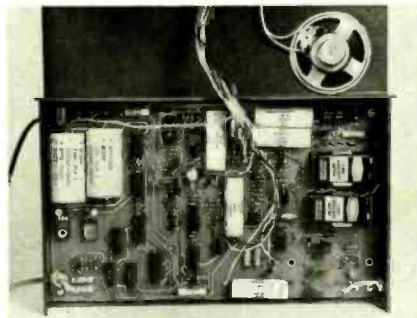

MINDPOWER: ALPHA printed-circuit board mounted in metal case.

The IC sockets are inserted, pressed in, then sparingly soldered to the foil side of the board. (Use a 25-watt iron with a small, conical tip and do not dwell on a pad for more than a few seconds. Otherwise you will cause foils to delaminate.) Next, install transistors Q1-Q15 being careful to orient them correctly. Diodes are installed next and the same care should be exercised.

Resistors are installed next, and here it is worthwhile to remember that $\frac{1}{4}$ -watt composition resistors are fairly fragile. Form their leads before inserting and don't be too vigorous in pressing them into place. A cracked resistor can be next to impossible to find by usual troubleshooting methods. There are 91 resistors to be installed on the board. Check values carefully against the parts list and Figure 3 before installing each resistor. Also, check again after all resistors have been installed. A wrong resistor value in a wrong location can be tedious to find later.

Next, install capacitors. Electrolytic capacitor polarity is indicated by a (+) mark on the board opposite the hole that accepts the positive lead of the capacitor. Disc and the non-polar tubular capacitors are installed, as shown, without regard for polarity. Note that 10 μ F electrolytic capacitors C31 and C32 do not have pad holes on the board. These capacitors are soldered directly to the foils on the parts side of the board. The positive side

of C31 connects to the +15 volt output of the regulated supply, and the negative side goes to the ground foil. Conversely, the minus side of C32 connects to the -15 volt output of the regulated supply, and the positive side goes to the ground foil. Capacitor C33 is soldered to the transformer wires that connect to points 23 and 24 after those wires are soldered to the board.

The +15 and -15 volt regulators, IC23 and IC24, are soldered to the board in the plated-through holes. The -15 volt regulator (an MC 7815) is installed with its brass-colored heat-sink up.

The two battery clips for installation of BATT1 and BATT2 are each secured to the board by short No. 4-40 screws and nuts. Screw heads are on the bracket side of the board and nuts are tightened from the foil side. When this stage of assembly has been reached, set the partially completed board aside and install parts on the case top.

Four slide switches S1-S4, control R92, and a miniature 8-ohm speaker are installed on the case top-half. The BATTERY switch S3 installs in the left-most punched rectangular hole in the case top. Next comes BEEP switch

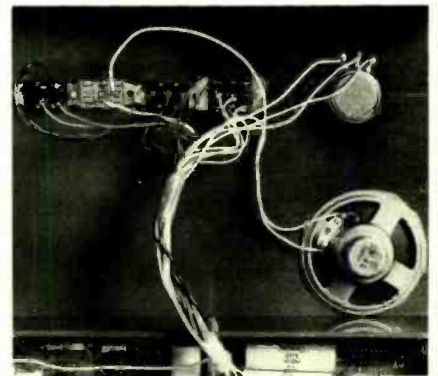

REAR VIEW of the front panel

S4, followed by ALPHA test switch S2, and finally, MODE switch S1. THRESHOLD control R92 mounts in the round hole with its mounting hardware. The miniature speaker is glued to the inner vinyl surface of the case

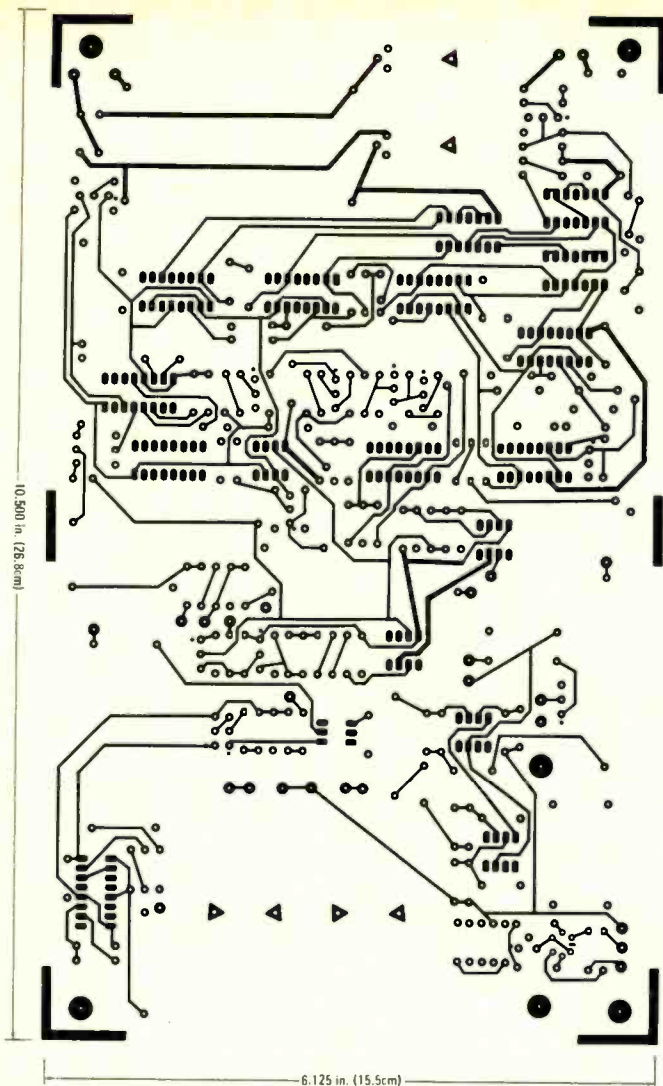

FIG. 1—MINDPOWER: ALPHA PRINTED-CIRCUIT BOARD foil pattern of the bottom of the double-sided board shown half-size.

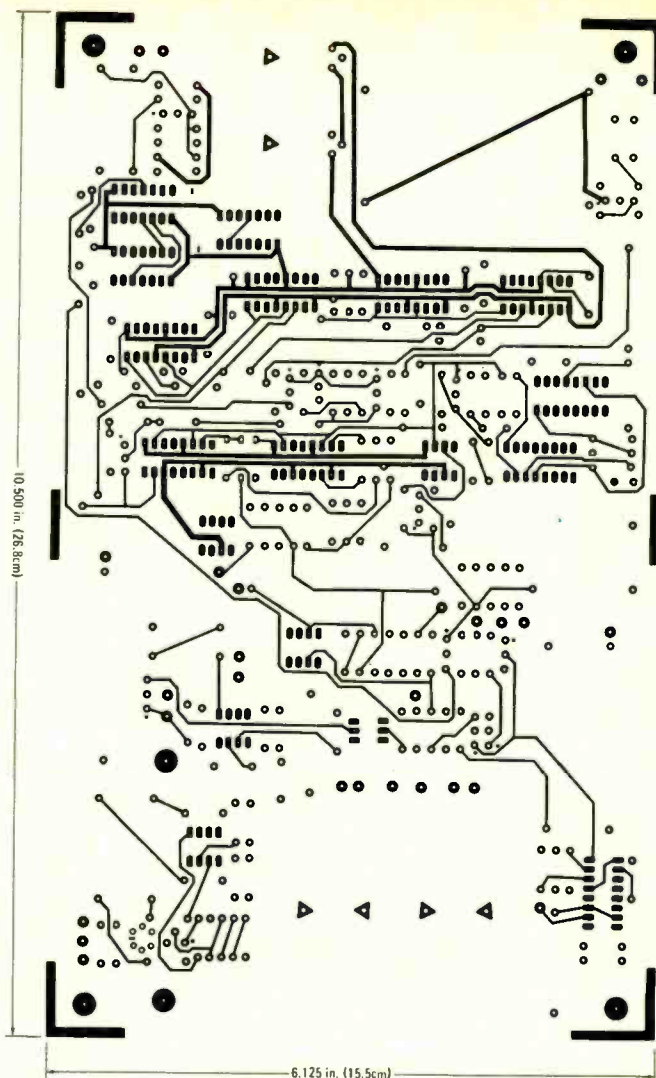

FIG. 2—PRINTED-CIRCUIT BOARD foil pattern of the component side of the double-sided board shown half-size.

top beneath the drilled speaker opening. Apply contact cement sparingly to the outer rim (not the paper cone) of the speaker and press into place. Allow to dry before proceeding.

To interconnect the parts mounted on the case top, with the board, a simple wiring harness is needed. Each attachment point on the board bears a number (also shown on the schematic) and its destination is illustrated in Fig. 4. To ensure just the right wire length, lay the board next to the case top and lay out enough wire to reach from a numbered board point to the attachment point on the case-top. Now, add a few inches so that there's enough slack to bundle the wires at about the middle of the case top. You should be able to wire-up the parts, but still neatly gather and tape the wires into a harness bundle. Using this method, you'll be able to open up your unit without having wires in your way.

Attach battery terminal wires to the designated board points and dress the wires between the battery clips. Next, pass the wires of the external power transformer, the video output cable and the headband electrode cable, through the holes in the sides of the case bottom. Tie a knot in each entering cable for strain-relief. Leave about 2 inches of free wire end on each. Now, pull through the wires and cables, strip the wire ends and

solder them to the proper points on the board, as shown in Figure 4. After connecting transformer secondary wires to points 23 and 24, be sure to solder bypass capacitor C33 across these two points. The finished, interconnected board can then be drawn back into the case by taking up the slack on the wires. To mount the board, push through screws from the outside of the case bottom, install 1/4-inch spacers, and fasten with four nuts from the parts side of the board.

Finally, the IC's are installed. Great care is required in handling IC's, especially IC1-IC4, and IC21, all of which are CMOS types susceptible to damage from static discharges. The other IC's, though not as static-sensitive as the CMOS types, still require a gentle hand in inserting them into their respective sockets. Pay particular attention to correctly orienting the IC's when inserting them. (Note: In the accompanying photos, IC13 is shown as a TO-5 metal can package, with leads formed to fit the IC socket. In actuality, this IC is supplied in the parts kit as an 8-pin DIP, similar to the other IC's. For this reason, it is shown as a DIP in Fig. 3.

Upon completion, spend some time checking your work. Be critical and don't close your eyes to small defects like excessive rosin, solder flakes or loose foils. Every minute you



POWER comes from an external transformer.

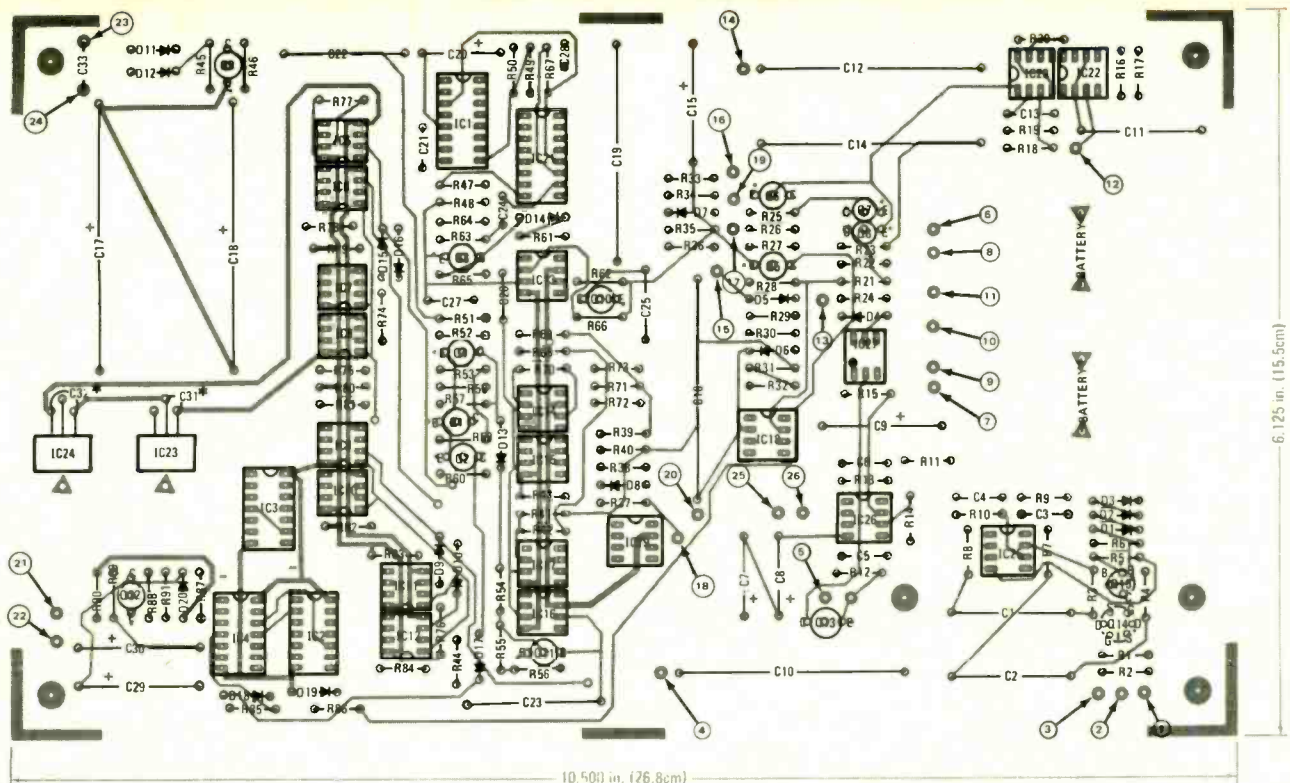

* POSITIONED ON TOP OF BOARD. SOLDERED DIRECTLY TO FOIL.

FIG. 3—COMPONENT PLACEMENT diagram. Circled numbers are interconnect points to external components.

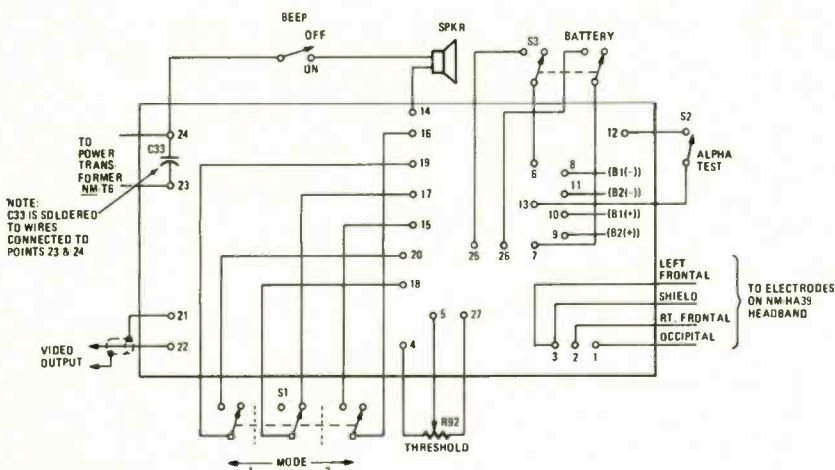

FIG. 4—INTERCONNECT DIAGRAM showing connection of external components to printed-circuit board.

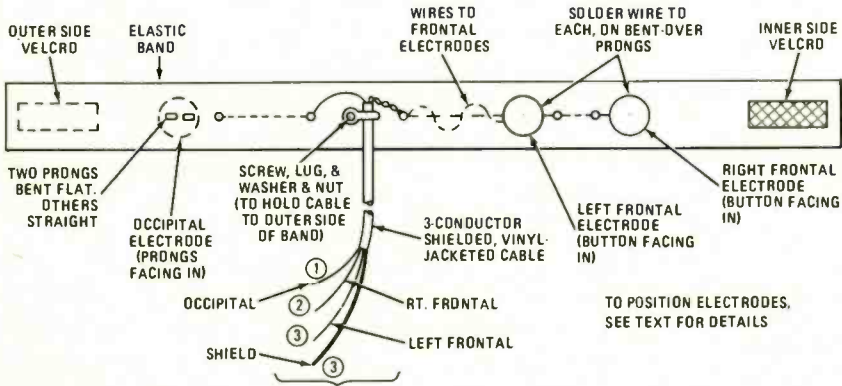

FIG. 5—HEADBAND ASSEMBLY details. View is from inside surface of headband.

invest in checking now could save you troubleshooting time later. Once you are satisfied that everything is correct, set aside the assembled unit and start fabricating the headband electrode assembly.

Headband assembly

The elastic headband assembly that holds the three EEG electrodes against the skin surface of your head is assembled from parts contained in the Headband Electrode Kit (NM-HA39) (see parts list). Assembly of these parts deserves care and attention, for it is through these electrodes that the tiny potentials of your brainwaves enter the Mindpower Alpha circuitry.

Figure 5 is an assembly plan of the headband. The elastic band comes with pre-attached Velcro fasteners, located to permit snug attachment of the band to any size scalp. Four metal electrode buttons are provided, although only three of these will be used. Note that one of the four buttons has extra-long prongs. This is an occipital (back of the head) electrode, intended for use by people who have a substantial amount of hair covering the skin at the back of the head. The long prongs are intended to face inward and to comb-through the hair to touch the skin below at several points, thus providing a low-impedance contact. For those blessed with a lesser covering of hair at the back of the head, a better choice for the occipital electrode will be one of the buttons having shorter prongs. Plainly, where the hair is thin, there is less cushioning and the button with shorter prongs will be more comfortable in combing through a sparse hair covering.

To begin assembly of the headband, first mark the positions of the electrodes. Wrap the band about your head so that the closing ends overlap just above your right ear. Pull the band snugly, but comfortably tight, and

Be the “New Professional” in electronics

**CREI trains you at home
for one of the most important
career levels in electronics—
plus offers you special
arrangements for engineering
degrees**

Most people think there are only two levels of careers in electronics: the technician level and that of the degree engineer.

There is, however, a third and very important level. It is that of the engineering technician or *practical* engineer. The growing importance of this career level has created what might well be called the “New Professional” in electronics.

If you look at the various levels of employment in electronics, you will understand why this “New Professional” is so important.

The average technician is a person who has had vocational training in electronics. He understands the basic principles of electronics so he can troubleshoot, repair and maintain equipment. He usually works under close supervision in performing his duties.

The engineer has college training in electronics. He usually supervises technician personnel and is responsible for planning and developing of electronic equipment and systems. Frequently, however, engineers are more heavily trained in the scientific principles of electronics and less in their practical application.

The engineering technician, by contrast, is a specialist in the practical application of electronics. His training usually consists of a two-year college program in electronic engineering technology. In many organizations, the engineering technician handles several of the responsibilities of the degree engineer. He often has the title of engineer.

CREI programs are designed to give you at home the same level and depth of training you receive in a two-year college program in electronic engineering technology. CREI programs are, in fact, more extensive than you will find in many colleges. And CREI gives you the opportunity to specialize in your choice of the major fields of electronics.

Unique Design Lab

CREI gives you both theory and practical experience in circuit design with its Electronic Design Laboratory Program. The professional equipment included in this program allows you to construct, test out and correct the circuits you design until you have an effective circuit.

This Lab Program helps you understand advanced electronics. It also gives you practical experience in many other important areas of electronics, as in pro-

Career Training at Home

prototype construction, breadboarding, test and measurement procedures, circuit operation and behavior, characteristics of electronic components and how to apply integrated circuits.

Only CREI offers the unique Lab Program. It is a complete college Lab and, we believe better than you will find in most colleges. The "Lab" is one of the factors that makes CREI training interesting and effective. And the professional equipment in this program becomes yours to keep and use throughout your professional career after you complete the training.

Engineering Degree

CREI offers you special arrangements for earning credit for engineering degrees at certain colleges and universities as part of your home study training program. An important advantage in these arrangements is that you can continue your full time job while "going to college" with CREI. This also means you can apply your CREI training in your work and get practical experience to qualify for career advancement.

Wide Program Choice

CREI gives you a choice of specialization in 14 areas of electronics. You can select exactly the area of electronics best for your career field. You can specialize in such areas as computer electronics, communications engineering, microwave, CATV, television (broadcast) engineering and many other areas of modern electronics.

Free Book

In the brief space here, there isn't room to give you all of the facts about CREI college-level, home study programs in electronics. So we invite you to send for our free catalog (if you are qualified to take a CREI program). The catalog has over 80, fully illustrated pages describing your opportunities in advanced electronics and the details of CREI home study programs.

Qualifications

You may be eligible to take a CREI college-level program in electronics if you are a high school graduate (or the true equivalent) and have previous training or experience in electronics. Program arrangements are available depending upon whether you have extensive or minimum experience in electronics.

Send for this **FREE** Book describing your opportunities and CREI college-level programs in electronics



Mail card or write describing qualifications to

CREI **CAPITOL
RADIO
ENGINEERING
INSTITUTE**

McGraw-Hill Continuing Education Center
3939 Wisconsin Avenue Northwest
Washington, D.C. 20016

Accredited Member National Home Study Council

GI Bill

CREI programs are approved for training of veterans and servicemen under the G.I. Bill.



mesh the Velcro ends. Now, standing before a mirror, place a mark on the band directly above the center of each eye using a piece of chalk. This will establish the positions of the right frontal lobe active electrode and the left



HEADBAND ASSEMBLY of Mindpower: Alpha.

frontal reference electrode. Now, place the base of your left hand's index finger against the top of your left ear, and extend your finger tip to the band at the back of the head. Place the chalk on the band against your finger tip, and you will establish the position for the occipital electrode.

Remove the band and lay it flat. Position it with the two frontal electrode marks to the right and facing down. Place the prongs of an electrode button on the band behind the rightmost mark and press the prongs through the band's fabric. Now, repeat the process to mount the left frontal electrode. Crimp all of the prongs over on the outside of the band to hold the two frontal button electrodes in place. (The smooth button side is the inside surface.)

Now, mount the occipital electrode, working from the outside *in*. Place the selected occipital electrode directly *over* the chalk mark and press its prongs through the fabric. Crimp *only two* of its prongs flat against the band leaving the remaining prongs protruding. This means that you will now have one electrode at the left, formed by prongs and two smooth button electrodes at the right of the band.

TABLE I—CHECK-OUT PROCEDURE

FROM	TO	USING	RESULT
IC23 out	Point 24 (gnd)	VOM	+ 15 VDC
IC24 out	Point 25 (gnd)	VOM	- 15 VDC
Point 25	Point 10	VOM	- 9 V (S3 ON)
Point 26	Point 11	VOM	+ 9 V (S3 ON)
IC1 (pin 9)	Point 24 (gnd)	Scope	Approx. 7V in-lock

Standing before the mirror again, fit the band to your head with the two frontal electrodes on the forehead above your eye centers. The prongs of the rear occipital electrode should now comb through your hair to contact the skin surface at the back left of your head.

Once the electrodes have been assembled to the band, you are ready to attach their lead wires. Begin by removing about 12 inches of the electrode cable's outer sheath and shield braid. This will reveal the three insulated wires of the cable. Crimp a solder lug around the outer sheath of the cable just below the point where the wires exit. This will be used as a strain-relief. Simply punch a tiny hole through the elastic band about 5" to the right of the occipital electrode. Now, insert a 1/4" No. 4-40 screw (with washer on) through the band from the inside, slip on the lug from the outside, and secure in place with a No. 4-40 nut. Twist together the two insulated wires leading to points 2 and 3 on the PC board. Punch two small holes in the electrode band between the cable attachment point and the first electrode to the right. Thread the twisted wires through these holes. The first electrode is the left frontal (isolated ground) electrode. Cut to length the wire leading from PC board point 3, strip its end and solder it to the crimped prongs of that electrode. Punch two more holes in the band between the first and second electrodes and thread through the wire from PC board point 2. This wire should then be stripped and soldered to the crimped prongs of the right frontal electrode.

To complete assembly, punch two more

tiny holes between the cable attachment point and thread the remaining wire leading from PC board point 1, through both, and solder it to one of the crimped-down prongs of the occipital electrode. This completes assembly.

Check-out

After a final check of all wiring and connections, you should make a few voltage checks to ensure that all is functioning correctly. Install 9-volt batteries BATT1 and BATT2, and insert the prongs of the power transformer assembly into an AC wall outlet. Table 1 lists the measurements that should be made during the check-out procedure.

When these checks have proven satisfactory, set the BEEP switch S4 to ON and move ALPHA switch S2 to the TEST position. You should hear a rapid succession of 1-kHz "beeps" from the speaker signifying that the alpha test oscillator is keying the speaker, as would amplified alpha. To check the input amplifier, run the THRESHOLD control up and down. At maximum, you will hear some 60-Hz modulation of the alpha test beeps. At minimum, the tones will be crisp and clean. (The 60 Hz modulation results from stray pickup by the "open" electrode circuit. When electrodes are placed on the head, the electrode circuit is "closed" and 60 Hz pickup is minimal because of the differential input circuit.)

When you have reached this stage, you are ready to connect your Mindpower: Alpha to the TV set for some fascinating experiments in video biofeedback.

HORIZONTAL SYNC

This one is beginning to get to me! Wards Airline GHI-4836. The problem is very bad horizontal sync. You can set it up and it works for a moment, then jumps out of sync. Moving the horizontal hold control will make it lock, then it goes out again. I've checked everything I can think of. I note that touching the horizontal oscillator plate with a scope probe makes it go out of sync. When I take the probe off, it comes back temporarily. Should I take this down to the creek and make a fish-trap out of it or what?—C.S., Vergennes, IL.

Probably wouldn't make a very good fish-trap; let's fix it. This sounds very much like a thermal. Something is changing in value as it warms up. Try heating and cooling various parts. The oscillator plate should *not* be that sensitive. Sounds very much like a resistor increasing in value to me. (Feedback: Right! 18K resistor across horizontal oscillator plate coil read anywhere from 100K to 200K, out of the circuit on the bench! Thanks!)

"ADD-ON" AUTOMATIC FREQUENCY CONTROL?

Is it possible to install an automatic frequency control in an old Zenith model FM radio? This is a model G-725.—O.B., Monett, MO.

Frankly, it would be pretty hairy to add something like this to an existing design, even in a tube chassis like this. Suggestion; if you are having oscillator drift problems in this

chassis, check that little ceramic capacitor across the oscillator coil. This is a negative-temperature-coefficient type, and was used to correct drift. We replaced several of these when these sets were new! Aerovox part number for this capacitor is CN22JN080 and it's a 22-pF unit.

WHITE COMPRESSION

The picture looks odd on this Philco 7L40. It looks something like white compression. The brightness control has no effect. All of the DC voltages on the picture tube read about + 300 volts! No; the cathode is about normal. The grid resistance to ground is too low. 1.0 megohm normal. What is this?—J.D., Mena, AR.

You have a shorted blanking coupling capacitor, C46, the .0022 μ F from the vertical output transformer to the picture tube grid.

WIDTH COIL

I have an old Capehart CT-125 TV that I'm working over. I need a width coil for it. It works fine but I have no AGC and sync.—V.M., Mission, TX.

Tight! This is one of the old dual-winding types—you get the AGC and sync keying pulses from the secondary of the width coil. You can get a Triad WLC-29 that is listed as a replacement for the original part number that I'm not going to copy since it's so long! Thordarson WC-26 is also a sub.



FIG. 1—DEMONSTRATION of the Digital Time Delay System. Robert Berkovitz, research director of Acoustic Research, sets up demonstration as David McIntosh, circuit designer, looks on.

Digital Time Delay System For Concert-Hall Sound

A prototype system used in audio research that can create a concert hall of any size and shape in any typical listening room

LEN FELDMAN

CONTRIBUTING HI-FI EDITOR

IN THE EARLY DAYS OF HIGH FIDELITY, IT was fashionable to describe the end goal of all hi-fi as being the "ability to recreate the concert hall in your living room." As time went on (and as audiophiles became more sophisticated and knowledgeable), the industry soon came to realize that such a goal was, at best, highly elusive. A home living room has neither the cubic volume nor the acoustic properties of a large concert hall and no amount of "wishing" would make them the same. Furthermore, it has long been conceded that part of what gives listeners the "feeling" of attending a live concert is psychological or psychoacoustic in nature. We sense the fact that we *are* in a large hall because of visual clues as well as aural ones. The audience around us, the plush seats, the brightly lit stage upon which the musicians perform—all these things contribute to our sense of the "live performance".

During the brief but short-lived heyday of quadriphonic sound, many proponents of 4-channel audio maintained that this multi-channel reproduction technique could bring us a step closer to "concert hall sound" in our homes. The fact is, though, that much of what was passed off as "concert hall ambience" in 4-channel records and tapes was, in reality, nothing more than a form of "surround sound" that was

deemed most unnatural by many listeners who resented being bombarded by vocalists and instruments located behind their backs. Until recently, it appeared that the only way to make a hi-fi music system sound like it was reproducing a concert hall performance was to transport speakers, amplifiers and program source into an actual concert hall. The hall would then provide the required acoustic qualities that are missing in any home version of the performance. Much of the success of some of the early "live versus recorded" concerts that were a popular audio sport in the earliest days of component hi-fi are now attributed to the fact that *both* the live performance and the electronically reproduced equivalent were, in fact, taking place in a large and acoustically identical auditorium or concert hall.

Still, with the aid of modern computers it should be possible to study the exact nature of all the sounds—primary and reflected, phase shifted and attenuated, coherent and incoherent—that reach a listener's ears when he or she attends a live concert. And if all these elements of sound can be programmed electronically and reproduced from a sufficient number of directions or points of origin, it should be possible to "fool" a listener into believing that he or she is, in fact, attending a live concert when all

the while that listener may be sitting in a darkened room no larger than the proverbial "typical home listening room". At least that is how Bob Berkovitz of Acoustic Research and his engineering team headed by David McIntosh reasoned some time ago when they first began a project that led to the Digital Time Delay system described here. Much of what follows was learned during a brief but fascinating trip up to AR's plant a few months ago, and the author is indebted to the people at Acoustic Research for letting us in on this exciting research project, and for supplying some of the photos appearing in this article.

Background

A listener at a concert hall hears at least three effects of concert hall acoustics. One of these is the arrival of sound from a number of directions in rapid succession; first from the stage (called the "direct" sound) and then from various reflecting surfaces inside the hall. A second effect is the incoherence of high (treble) frequencies that makes it difficult for a listener to localize the sound source and at the same time gives an open, airy quality to concert hall sounds. The third effect is the familiar gradual decay of sound after it has stopped originating from the stage. This last effect is often successfully simulated

during recording, so that there seems no need to recreate it during the playback process.

The first two effects, however, cannot be conveyed by conventional sound reproduction techniques, according to AR. The failure of conventional high-fidelity equipment to reproduce the two missing effects is probably one of the main reasons for the artificial quality of the reproduction of orchestral music in the home, even when the components used are accurate insofar as frequency response and negligible harmonic and IM distortion are concerned.

The premise upon which AR's research was based is that "concert hall acoustics" can be electronically simulated and added to the reproduction of ordinary stereophonic records and broadcasts. Two phases of study and research were involved, both of which were carried on simultaneously.

First, it was necessary to define the acoustical properties of large halls in order to understand the patterns of reflections and the type of sound distribution that takes place in such halls or enclosed spaces. Mathematical models of halls were used in this study, since the objective of the study was to understand the acoustics of an ideal hall rather than how to build one in a true architectural sense. The program that was used to characterize different halls utilizes such data as hall dimensions, sound source and listener location (specified in three dimensions), absorption coefficients for each of the interior surfaces of the hall, absorption coefficients for areas of special absorption on any of the interior surfaces, the dimensions of those special areas, and the specific time period that the user of the program wishes to examine closely.

A number of studies indicate that the subjective effect of early reflections of a large hall is different from that of later reverberation. These studies further indicate that the time period in which the acoustical "character" of a hall is sensed by the listener is approximately 100 milliseconds (one tenth of a second). In this time, following the attack transient that represents the start of the musical sound, our ears and brain form an idea of the size and diffusion of the sound source and of the setting in which the source and listener are located. Mathematical modelling of simplified rooms, implemented with computers, provides a highly precise way of determining the basic image locations in time and space. This, in turn, allows the user of the program to look for patterns that correspond to different subjective effects. The data from the output of the computer can be used to set the operating characteristics of an appropriate simulator and the subjective effects of different "halls" can then be compared and analyzed electronically.

Reproduction simulator

A sixteen-channel delay system was developed by Acoustic Research that converts the computer generated information into equivalent acoustical properties in a listening room. In the tests we heard, sixteen AR-7 loudspeakers, mounted in two tiers of 8, reproduced delayed sounds. A pair of AR-11 loudspeakers were used for reproducing the regular, undelayed stereo channels. Figure 1 shows Robert Berkovitz, research director of AR, as he enters computer generated data into a prototype of the Digital Time Delay System during the recently held Audio Engineering Society Convention in Zurich.

Figure 2 is a closeup view of the control panel of the Digital Time Delay System. Each knob is used to set up the

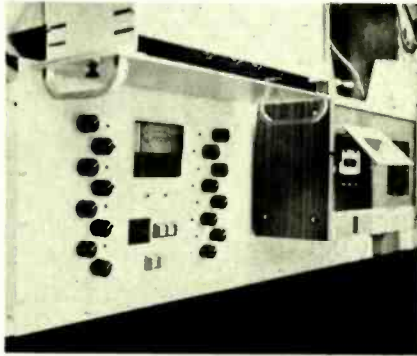

FIG. 2—FRONT-PANEL of the Digital Time Delay System. Sixteen knobs control the time delay of the 16 channels.

proper time delay for one of the sixteen reproducing channels used in the system. Sixteen channels were chosen simply because the number 16 works out well in terms of available digital IC specifications. The sixteen-channel delay system is actually a special purpose computer designed and built at AR. It operates by sampling the incoming music signal at approximately 30,000 times per second, converting the level of each sample to a number that is then stored in the correct location of a digital memory. This memory contains the last quarter-second of program material fed to it.

The component side of a memory

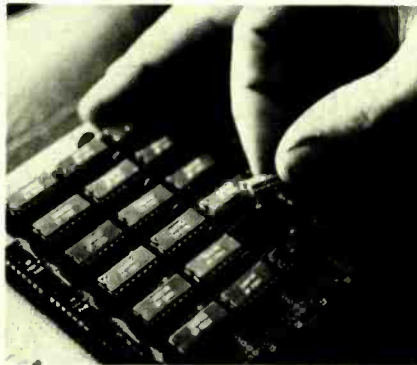

FIG. 3—MEMORY BOARD contains 96 memory IC's for a total storage of 98,000 bits.

board in the Digital Time Delay system is shown in Fig. 3. Each memory IC (a monolithic circuit with the equivalent of 7000 transistors) has a storage capability of 1024 bits of information. In this application, the "bits" are music signals encoded in digital form. The total system contains 96 memory IC's, for a total storage of 98,000 bits, which corresponds to the required maximum time delay of one-quarter second. The Digital Time Delay system could be expanded to provide longer delays if required and, because the music is digitally encoded before storage, its quality is unaffected by the length of time that it is delayed.

The wiring side of a memory card used in the Digital Time Delay system is pictured in Fig. 4. The wire-wrap technique used allows rapid construction and modification of circuits while providing high reliability. There are over 1500 connections on this 4 x 10 in. wiring surface!

After the value of each sample has been stored, and before the next one is taken, a memory recall circuit reads sixteen samples from as many memory locations and sends each sample to one of the sixteen output channels. Each channel drives a loudspeaker system placed to cover one-sixteenth of the space above and around the listener. When the system is operating (reproducing musical program material), reproduced sound comes first from the

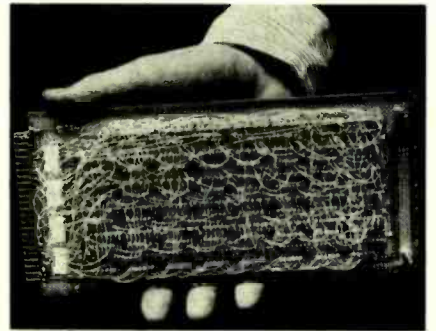

FIG. 4—MEMORY BOARD measures 4 x 10 inches and contains over 1500 connections.

two conventional stereo loudspeakers located in front of the listener. Then, after delays of fractions of a second (determined by the particular program used), the same information is successively reproduced from each of the sixteen delay channels. The audible sensation to a listener sitting "inside" the system is that of listening to music in a hall whose size, shape and acoustical character depend upon how the system controls are set.

Listening tests

In our own listening tests, the illusion of being in a large concert hall was tremendously enhanced when the lights in the demonstration room were extin-

guished, which confirms what we said earlier about the psychological aspects of concert hall attendance. But, with that reservation aside, the overall sonic effect of the experiments was uncannily real. Not only were we able to sense the spaciousness of a large concert auditorium, but as Mr. Berkovitz altered the parameters of our simulated concert halls, we were even able to sense the direction in which the "dimensions" of the hall had been changed.

A most unnerving experience occurred when the controls were altered so as to "build" a concert hall that could not be realized architecturally. (As I recall, one wall was "turned around on itself or "stretched" beyond physical reality while in another instance unrealistic side alcoves were "implanted" in our make-believe hall). When these architectural aberrations were imposed, our lifetime of listening experience immediately rejected the audible results as being "unnatural"—or just plain weird!

A consumer product?

Readers of R-E will recall that just a few months ago we reported about a Digital Time Delay System developed by Audio Pulse that was ready for consumer use. Obviously, the more

complex and elaborate sixteen-channel simulator now developed by Acoustic Research is not quite ready for consumer packaging (nor could any consumer of our acquaintance afford it if it were). According to Robert Berkovitz, the entire project was initiated without a specific end-product in mind—as purely a research tool to investigate those remaining unknown factors in human hearing that are greatly in need of further study. The system will be used, no doubt, by acousticians and architects and could well serve as an important tool for such craftsmen who must design the concert halls of the future. Theoretically, new shapes and materials could be "tried" using the simulator before thousands or even millions of dollars were expended on new architectural realities that might or might not prove acoustically satisfying after the money has been spent.

In our auditioning of different stereo records, we noted that the techniques brought to bear in the original recording by the recording engineer had some effect upon the way in which the "hall" was simulated acoustically, but not nearly so much as we would have imagined. In other words, the simulated acoustics created by the sixteen-channel digital time delay system played a much

larger role in this listener's subjective evaluation of the "space" in which the music was being reproduced than did any artificial reverberation or decay time introduced into the original stereo discs that we listened to. The "hall" sensations were there (and similar) whether we listened to a so-called "live" stereo disc (one recorded from master tapes originally made at a live performance) or to a studio-type multi-channel recording more typical of today's recording techniques used for modern or "pop" music.

In summarizing the work done at Acoustic Research Bob Berkovitz did not firmly rule out the possibility that such multi-channel digital time delay systems would someday be economically and technically feasible for a home product. Based upon the rapid strides we have seen in recent years in large-scale integration and miniaturization, we suspect that a product for home use will be here sooner than ever. As for the question of where we will put those extra sixteen speakers, take comfort in the fact that they need not be as large in size or high in quality as the two primary stereo channel speakers that must still supply the "direct" sound even in the home concert hall of the future. R-E

SPECIAL POWER TRANSFORMER

I've been trying to locate a power transformer for a Scott 299 for some time. I would appreciate any help I could get; no one seems to have an exact replacement. The specs are as follows: high voltage, 390 VCT. Filament, 5 V at 3A, 6.3 V at 4.2A. Bias, 50 volts at 150 mA. Do you have any ideas?—R.Z., Buffalo, NY.

I'm full of ideas! Now let's see if any of them are worth a darn. Sams 445-13 shows that this is a stock transformer, except for that bias winding. Why such a high current rating on that one? 150 mA. Oh, oh. Now I see. They are also using this as a DC source for the heaters of the preamplifier tubes! That's why the 150 mA.

I have a listing of a Thordarson 22R123 transformer that is fine except for the current rating of the bias tap. Everything else matches. Hey! This transformer also has a 12-volt heater winding rated at 5.0 A! Do this: put a diode in series with this, with a filter capacitor, and use the resulting DC to feed the preamp heaters. Then the bias tap will have plenty of voltage!

RASTER WITH VIDEO AMPLIFIER OUT?

I've got all sorts of problems in this Zenith 20X1C38. If I pull the 12HL7 video output tube, I can get a raster of sorts. With the tube in, the high-voltage jumps up and down and then goes out. What does the crystal ball say?—F.L., North Bergen, NJ.

You've got one dandy "reverse symptom" here. When you pull the video output tube of a normal TV set, the raster should go out. Reason; the video output tube plate is supplied from +400 volts. With no load, this plate voltage (normal +330 V) should jump to +400, and the picture tube cathodes with it. This rise in cathode voltage makes the picture tube grids far more negative by comparison, and the tube should cut off.

I believe you'll find that someone has cranked all three of the picture-tube screen controls wide open. This will let the tube light a little even with such a bias upset. Run a grey-scale adjustment, and then find out why the plate voltage of the 12HL7 is so far off. Bad resistor, open peaking coil, etc.

LOW BRIGHTNESS

I can't find out why the brightness is so low on this Sears black-and-white TV. The DC voltages on the picture tube seem to be close; the cathode reads +225 V and the grid +178. If I touch pin 7 (cathode) with the voltmeter, the brightness jumps up right away. If I leave it there, it tries to get too bright. The tester seems to be bleeding off some of the excess voltage. I'm lost.—L.H., Buckley, WA.

No, you're not; you're in the right place. Your picture tube cathode is far too much positive. This makes the grid too far negative and cuts down the brightness. Normal should be; cathode, +188 volts; Grid, +139-volts for a net bias of -49 volts. You must be using a low-impedance DC voltmeter, to cause such a drop.

The DC voltage comes from the +174-volt source on the flyback, through a "spot-killer" diode, to the picture tube cathode through a 150K resistor. Check this diode; it could be shorted which would raise the cathode voltage.

NEW FORMULA FOR REMOVING "TAR SMELL"

I saw your note on tar smell from burnt-out transformers. I have another way; ran across the same problem some years ago. Tried several things and finally came up with this one.

Soak an old cotton rag in pure vanilla extract, and wash the affected area vigorously. Do not rinse off. If the user doesn't like vanilla, try cherry, almond or other flavors!—R.L. Ward, A-V Technician, E. Lansing, MI.

MISSING TUBE

I just got hold of a model 546 Supreme scope. Got nothing but a dot on the screen. One of the tubes is missing. This is a 5-pin type. Tried several, but none of them worked. What tube is this?—P.P., Astoria, NY.

This is a 885 gas triode (sometimes called a thyatron). It's the horizontal sweep generator; sort of a relaxation oscillator kind of thing. The tube is obsolete, but you might be able to dig one up from ads in the Classified section in the back pages of R-E. Several companies advertise old tube types. R-E

Selecting and Installing TV Antennas



BOOSTER MOUNTS ON MAST and connects between lead in and transmission coax. In typical installations the antenna should be mounted further above the chimney.

There's a lot of things to consider when undertaking this task. Here we look at the most important ones and see what it takes to get the best possible reception

JAMES E. KLUGE*

AN ANTENNA INTERCEPTS THE TRANSMITTED ELECTROMAGNETIC energy traveling through space and converts it into a voltage that the TV set can process into a visible picture. Ideally the antenna voltage should be an exact replica of what is transmitted by the broadcaster. A number of things can prevent that from happening. Some of them are:

- Impedance mismatch to downlead.
- Inadequate bandwidth.
- Broken or missing elements.
- Damaged, loose or misaligned elements.
- Loose signal connections.
- Unstable supports.
- Improper phasing or element spacing.
- Relative motion of elements in wind.
- Corrosion at joints and connections.
- Proximity to metal objects.
- Lightning damage.
- Strong reflections or signals from other sources.
- Disoriented or tipped antenna.

Each one of the above causes for poor pictures can be avoided either at the time you purchase an antenna or install it. Of the thirteen mentioned above, the last four can be avoided by proper installation. The others can be avoided by selecting the right antenna. Taking them one at a time, let's discuss how problems can be avoided.

Transmission lines

In most residential applications the delivery system consists simply of a length of 75-ohm coaxial cable or 300-ohm

* Technical Editor, Winegard Co.

twinlead connecting the antenna to the TV set. In some installations where more than one TV set is connected to the antenna there may be splitters, set couplers or line-drop taps distributing the signals throughout the residence. This would be considered a simple master-antenna television (MATV) system. Except where amplifiers are involved and where connections are bad, there is little chance for trouble. Where 300-ohm unshielded twinlead is used, keep it at least 6 inches from metal objects and *do not coil* it. Now, let's take a close look at antennas.

Impedance

Most TV antennas are nominally either 75-ohm or 300-ohm balanced. It's usually impossible to look at an antenna and determine its impedance. The manufacturer will usually specify it. You then match this impedance to the impedance of the downlead or, where not included with the antenna, install an impedance-matching transformer to convert from 75 to 300 ohms or vice versa. Mismatched impedances not only waste signal power but cause standing waves that result in smeared pictures.

Bandwidth

Again, there is no way to look at an antenna to tell what its bandwidth is. It can be observed only with sophisticated engineering instruments. You have to rely on a reputable manufacturer who has the measurement facilities and has specified the bandwidth of his product.

An antenna is like a tuned circuit. It will respond to frequencies within the bandwidth to which it is tuned and is

virtually unresponsive to frequencies outside that bandwidth.

Ideally, the antenna's response curve should be flat, with steep skirts at the cutoff frequencies. If it cuts off the edge of a channel too soon or too sharply it will attenuate either the picture, sound or color carrier. This will degrade picture quality on that channel. On the other hand, an antenna that does not cut off sharply outside the passband will make the antenna responsive to frequencies other than the TV signals, such as land-mobile radio, aircraft and FM broadcast.

Any of these can cause interference patterns in the picture. They represent extraneous signals not part of the original TV signal. Choose a manufacturer who has antenna design and measurement facilities plus an established reputation.

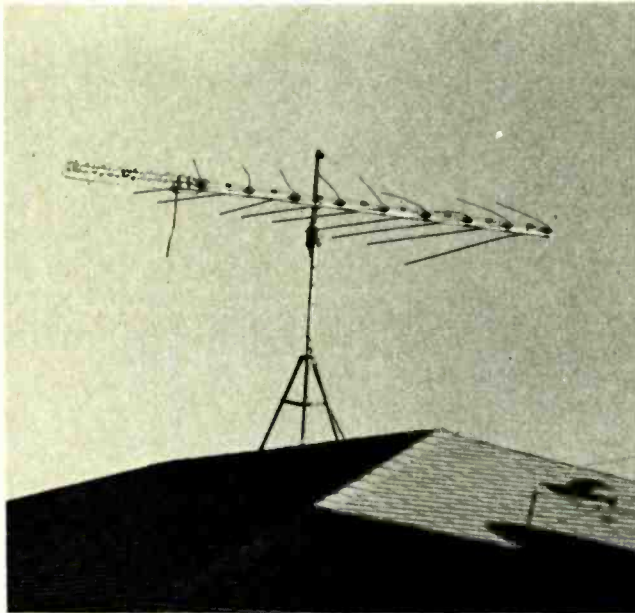

GOOD RECEPTION? NOT A CHANCE! Bent and twisted elements improperly aligned with each other and dangling (disconnected?) twinlead guarantee poor pictures at the set.

Antenna construction

Some antennas may look well constructed but after they're installed and severe weather gets to them, they show their weaknesses. Elements bend or break under stresses caused by heavy winds or ice loads. Element spacing and alignment are critical to phasing and affect the frequency response, impedance matching, gain uniformity and directivity.

Look for heavy-duty construction and reinforcing supports at points of maximum stress. Look for strength in mountings and fabricated parts—particularly for $\frac{1}{16}$ -inch diameter aluminum tubing used for long elements. Look for bracing and heavy-gauge materials where strong forces will be applied as a result of high winds and ice.

Where elements rotate into position and plastic or aluminum parts hold them captive for proper alignment, test the captive positioning device for rigidity and strength by subjecting the elements to bending and twisting forces.

Downlead connections, impedance-matching components and preamplifiers should be enclosed and protected from the weather. Typically they are enclosed in plastic housings to keep out dirt, rain and snow.

Well designed antennas are not only mechanically strong and electrically sound, but assemble quickly and easily. Fold-out elements that are self-locking and secure, involving a minimum of assembly time is the general rule.

People who earn a living putting up TV antennas must be able to do it quickly. An antenna installer's time is valuable as well as costly from the customer's point of view. Ease of assembly and speed of installation is as important as the cost of the antenna itself. It would be better that the installer do a

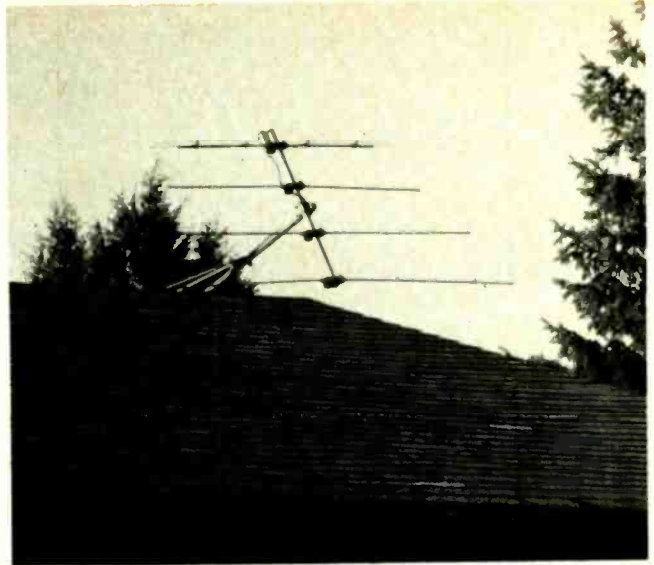

READY FOR SATELLITE BROADCASTS! With its skyward slant, this antenna will do better on signals from outer space than those from the nearby television transmitters.

signal survey on the roof to insure a good reliable signal than to spend that time assembling bolts, nuts and antenna parts on the ground. Avoiding costly callbacks is another good reason for selling and installing a line of good sturdy antennas made by an established and reputable antenna manufacturer.

The mast clamp, since it supports the entire antenna array, should receive careful scrutiny. A simple clamp with heavy bolts is not enough—the antenna load with all its twisting and bending motions must be transferred from the boom to the mast through that mast clamp. The boom and the mast must be strong enough to withstand these forces while the clamp locks them together rigidly.

Installation

Up to now much of our discussion has dealt with the antenna itself. As most of us know, the installation can make

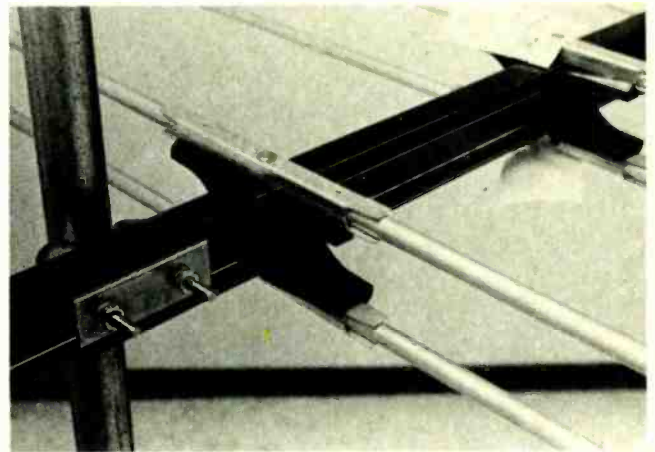

HEAVY 1-PIECE TUBULAR ELEMENTS locked to the boom by aluminum clamps and tough plastic supports will stand up.

or break the performance of a good quality antenna. How many people do you know who have condemned a tried and proven antenna simply because it was installed improperly? Good pictures depend on a good antenna that is properly installed to transform the airborne signal into a faithfully reproduced voltage applied to the TV set.

To begin with, the set needs at least 1000 μV (0 dBmV) at the antenna terminals. The AGC circuits in most TV sets can usually handle up to a few hundred thousand microvolts, except perhaps the small portables that prefer something well

under 100,000 μV (+60 dBmV). To measure these levels, a good signal-level meter (SLM) is necessary. If you can't buy one now, try to borrow or rent one until you feel you can justify the cost of buying one. When you do buy one, let me caution you on one thing.

When buying an instrument like an SLM, it doesn't pay to try to save a few dollars. Like good antennas, a high-quality SLM will pay you back many times over. One other thing, if you plan to get into MATV work some day, buy the more expensive but more accurate and useful MATV meter now—not later. Here's a good case where you get what you pay for.

If you can't justify buying or renting a high-quality SLM,

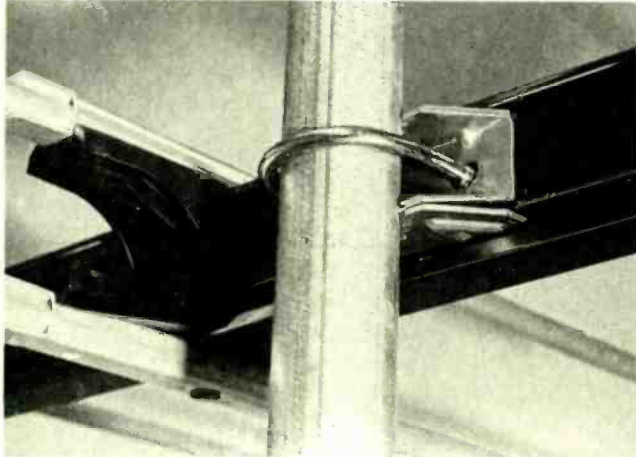

THE STRONG 3-PIECE MAST CLAMP transfers wind or other forces on the boom to the vertical mast. Clamp design prevents turning, avoids compression damage to boom.

then at least get yourself a good portable color TV so you can see what kind of a picture you're getting. Remember, the objective behind all this effort is *good pictures* on the tube. Because of AGC, a TV set will not provide an indication of relative signal strength.

Make a signal survey

Now that you have chosen the best antenna for the job at hand and are outfitted with the necessary tools to install it properly, do a signal survey. Don't look up and down the street to see how all the neighbors have installed their antennas and then follow suit. The first installer may have goofed. Subsequent installations, being the same, would produce the same poor pictures. Logical conclusion—this is a poor signal area. Don't believe it! Show the neighborhood that TV pictures can be good with a good antenna properly installed.

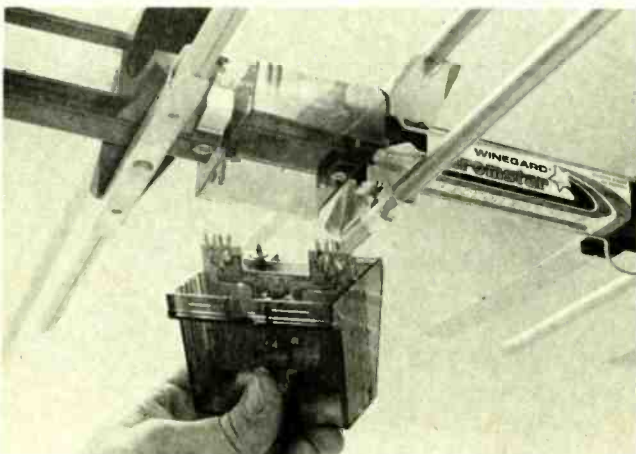

PLASTIC HOUSING PROTECTS BOARDS used for Impedance matching or combining UHF and VHF signals from weather or dirt.

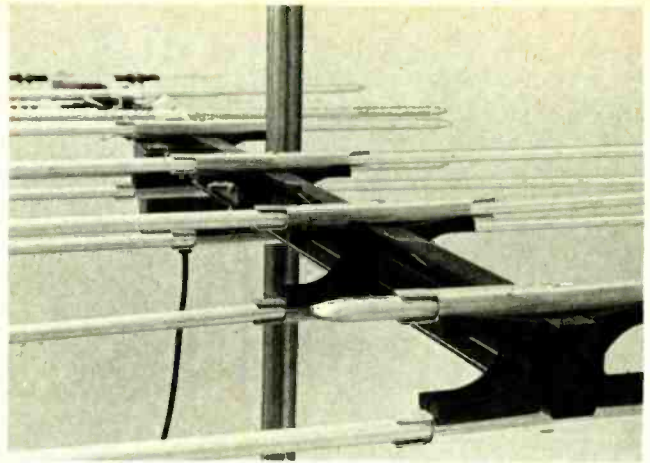

REAR VIEW OF WINEGARD CH-7078 shows heavy metal parts and tough plastic insulators designed to transfer wind and ice loads on $\frac{7}{16}$ -inch tubing to the 1-inch square boom. All elements rotate into position and lock into place to make a rigid assembly requiring minimum installation and labor time.

After you've unpacked and assembled the antenna, mount it on a short section of mast. Now, walk it around the roof while your helper or partner observes the picture on the portable TV and the SLM if you have one. It's not unusual to clean up a marginal-quality picture by moving the antenna one or two feet in any direction. Remember to check the *picture*—the SLM may indicate adequate signal but the picture may be full of interference patterns or ghosts. Be sure to check all channels, too—particularly the weakest ones.

Now that you've located the antenna, rotate the mast to orient it for the *best picture*—one free of ghosts and interference. If you can't eliminate them, you may have to stack antennas for greater directivity. According to theory, when stacking antennas on the same mast, there should be at least $\frac{1}{2}$ -wavelength or more spacing between the antennas—about the distance of the longest antenna elements. In actual practice, however, this is seldom done. With a spacing of 2 or 3 feet, three antennas can fit on a single 10-foot mast.

Don't just point the antenna toward the transmitter. You may get a better signal (picture) reflected off a water tower, high-rise building or mountain. This is why a good portable color TV is so important. And be sure it has a picture tube large enough to show up minor picture deficiencies!

Now that you've oriented the antenna properly, make sure it *stays that way*. Use plenty of guy wire to anchor the mast securely. Be sure the mast is prevented from turning, even in high winds. A large, well-designed antenna is highly directional. Even a few degrees of antenna disorientation can spoil good pictures.

Once the antenna is in place and secure, you have—in addition to a source of good TV signals—an excellent lightning rod. It needs to be grounded. Everything but the driven elements are connected to the boom and the mast. The mast then must be grounded through a tower or with heavy wire, either AWG No. 6 aluminum or AWG No. 8 copper. Grounding means a $\frac{5}{8}$ -inch metal stake 8 feet in the ground or a metal cold-water-pipe system. Since pipes enter buildings, the metal stake is usually preferred. Make good solid electrical connections to the mast and the stake or you will defeat your purpose. Also keep the antenna 6 to 12 inches below the top of the mast.

Your customers can now enjoy good color TV for years to come. However, they should be prepared for guests. Their friends and neighbors will probably enjoy watching your customer's TV more than their own. Although there could be, there just aren't that many good antenna installations around. Also, for those who don't install antennas, if you're so inclined, here's an opportunity to get into the business, turn over a handsome profit and make people feel they're getting something for their money.

R-E

555

IC TIMER CIRCUITS

The versatile 555 IC timer has many applications. Here are some interesting ones including pulse-width and pulse-position modulators

ROBERT F. SCOTT
TECHNICAL EDITOR

THIS IS THE THIRD IN A SERIES OF ARTICLES describing various applications of the 555 timer IC. In the article 555 Timer Applications (February 1976 issue), we saw how the device is used in the monostable mode as a time-delay generator and as a one-shot pulse generator. In March, we covered operation in the astable mode as a free-running oscillator generating pulses and squarewaves. We also threw in a few practical applications.

Monostable applications

Let's take another look at the basic monostable circuit (Fig. 1) and see how it can be

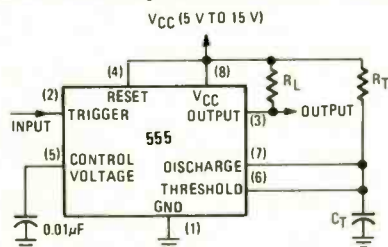

FIG. 1—THE 555 TIMER connected for monostable mode. Negative-going input pulse drives output high for interval equal to $R_T C_T$.

used for such applications as a heartbeat monitor, frequency divider, pulsewidth modulator and pulse-position modulator.

Recapping monostable operation: The output pulse is independent of the input waveform and is controlled by the time constant of $R_T C_T$. At the onset, C_T is held discharged by an internal transistor connected to the threshold control terminal. A negative-going pulse on the trigger terminal drives the output high and C_T begins to charge. When the voltage across C_T reaches the threshold level (in a time interval determined by $R_T C_T$), the output immediately returns to the "low" state.

Missing-pulse detector

When the 555 is connected as shown in Fig. 2-a, it can detect a missing pulse or an abnormally long period between two consecutive pulses in a train. Thus, it can be used to detect intermittent firing of a sparkplug in an internal combustion engine or to monitor the heartbeat of a sick patient.

When connected as shown and fed with a

continuous train of pulses, the timing interval of the monostable is continuously being reset by each pulse in the evenly spaced chain as long as the pulse spacing is less than the timing interval. A decrease in pulse frequency or a missing pulse permits completion of the time-interval so the output level goes high—triggering an alarm or other device connected to the output terminal. Figure 2-b

shows the circuit waveforms for a pulse train. The operation of the divider is based on the fact that retriggering cannot occur during the timing cycle.

The output frequency f_o of the divider equals f_{in}/N , where N is the division factor. Figure 3 shows the circuit waveforms for a divide-by-five operation of the timer. The timing period of the circuit is set to approxi-

TYPICAL APPLICATION DATA

MISSING PULSE DETECTOR

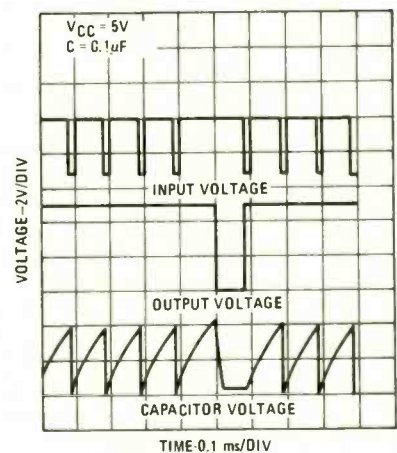
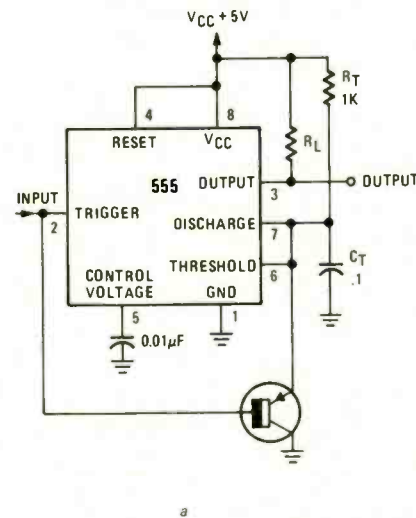

FIG. 2—MISSING-PULSE DETECTOR is shown at a. Waveforms at b shows how output goes low when there is a break in the input pulse chain.

shows the waveform when the timer is used as a heartbeat monitor or missing-pulse detector.

A shaper must be inserted between the pickup transducer and the input to convert the heartbeat or sparkplug signal into a series of negative-going pulses.

Frequency divider

If the frequency of a pulse chain is known, it can be divided down as required by feeding it into a basic monostable circuit (Fig. 1) and adjusting the length of its timing interval. When the timing interval ($T = 1.1R_T C_T$) is longer than the period of the input trigger pulses, only those pulses that are more than

approximately 4.5 times the period of the input pulse chain.

A second timer, or the second section of a dual device, can be used as a pulse shaper to adjust the duty cycle of the output waveform. Figure 4, from the Exar XR-2556 and Teledyne D555 data sheets, shows the device connected as a frequency divider and pulse shaper. The output of timer 1 is fed to timer 2 whose frequency is set to that of the output of timer 1. The duty cycle of the output waveform can be varied from 1% to 99% by varying R_{12} . Figure 5 shows the input and output waveforms associated with the frequency divider and pulse shaper shown in Fig. 4.

Pulse-width modulation

When the monostable-connected timer (Fig. 1) is triggered by a continuous pulse chain, the charge time of capacitor C_T and thus the duration of the output pulse, can be changed by varying the voltage on the control terminal. The waveforms in Fig. 6 show the operation of the pulse-width modulator.

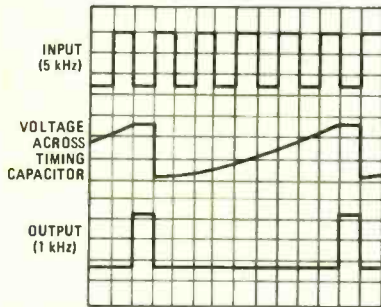

FIG. 3—FREQUENCY-DIVIDER WAVEFORMS from 555 set up to divide by five with 5-kHz input.

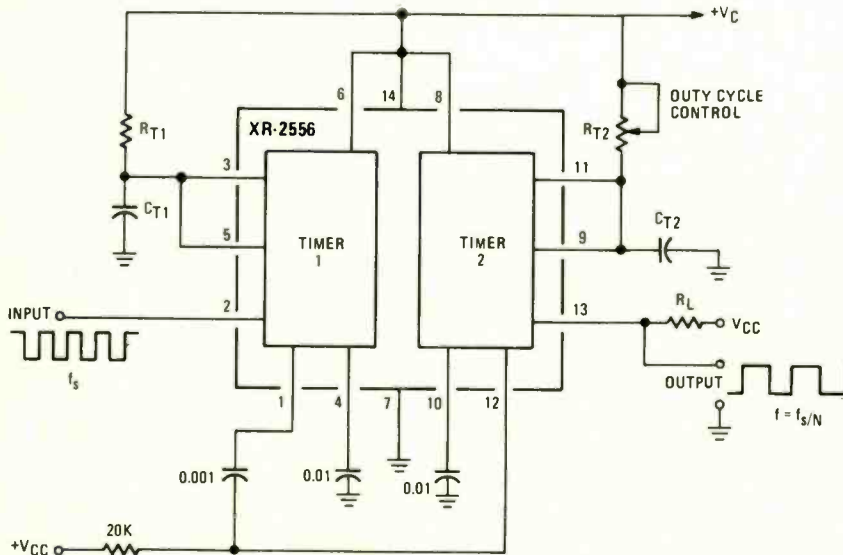

FIG. 4—FREQUENCY DIVIDER AND PULSE SHAPER. Timer 1 is frequency divider controlled by R_{T1} and C_{T1} . Timer 2 is a pulse shaper. The output duty cycle is set by R_{T2} and C_{T2} .

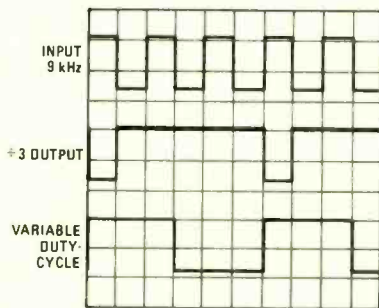

FIG. 5—WAVEFORMS associated with the divider and pulse shaper in Fig. 4.

(Note that in this application, the $0.010\text{-}\mu\text{F}$ decoupling capacitor must be disconnected from the control terminal. The modulation voltage can be direct coupled or fed through a suitable capacitor. Figure 7 shows how the voltage applied to the control terminal affects the pulse width or time delay developed at the output of the timer.

Pulse-position modulation

When the timer is operated in the astable mode, the instantaneous period or repetition rate of the output pulse can be varied by applying a modulation voltage to the control terminal. Figure 8 the timer as a pulse-position modulator and Fig. 9 shows the related waveforms. In this example, the timer operates as an oscillator whose output is modulated by a triangular signal. Note, however, that the modulating signal can have any desired shape and may be derived from another signal generator or from a pressure, temperature or humidity sensor.

Linear ramp generator

When the timer is operated so the timing capacitor C_1 charges through a resistor, the voltage across it increases logarithmically. If we need a voltage that increases linearly with time, we can replace timing resistor R_T with a constant-current source and take the linearly increasing voltage from across C_1 . In Fig. 10, a 2N2450, 2N4403 or similar transistor is connected as the constant-current source. Figure 11 shows the related waveforms.

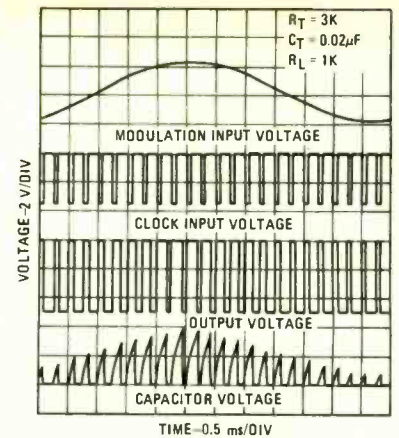

FIG. 6—OUTPUT PULSE WIDTH is determined by voltage on control terminal. Waveforms show circuit performance with sinewave control.

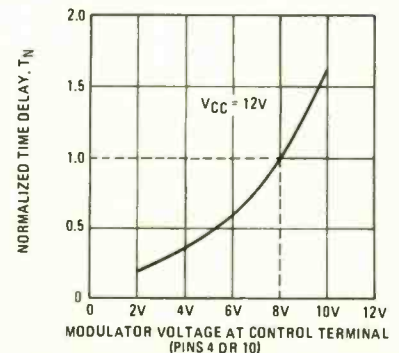

FIG. 7—HOW OUTPUT PULSE WIDTH or time delay varies with modulation voltage on control terminal.

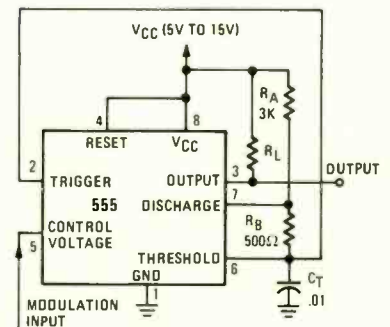

FIG. 8—ASTABLE OPERATION provides for pulse-position modulation when modulating signal voltage is applied to control terminal.

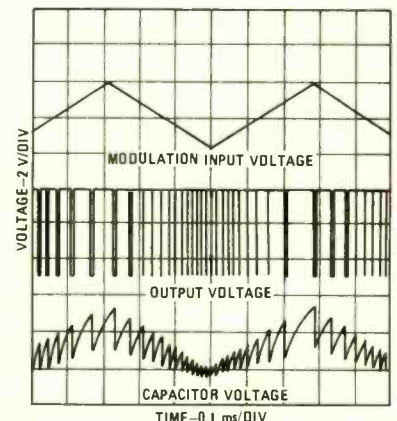

FIG. 9—PPM (PULSE-POSITION MODULATION) waveforms. Modulation voltage need not be symmetrical.

Another long-time timer

The last time around, we showed three timers connected in cascade to provide a time delay much longer than is practical with a single device. The overall delay is the sum of the delays in the three timers. Another method of achieving long delays is to use the scheme (Fig. 12) described in application notes supplied by most timer manufacturers. In this case, the two halves of a dual timer are connected in cascade with a type 8281 binary counter between them. The first timer is connected as an oscillator with a period of $1/f_o$. The 8281 counter provides selectable outputs (at times equal to 2, 4, 8 and 16 times the input) that are used to trigger the second half of the dual timer. The RC constants in the second timer are selected to give the desired output pulse length.

For your car

Figure 13 is a simple electronic tachometer described in Texas Instruments timer application note. It is operated by pulses generated as the car's distributor points open and

close. These pulses are shaped and clamped by the 1K input resistor and the 5-volt Zener diode. The processed pulses are then fed to the trigger input of the timer. The pulses on the trigger terminal cause the timer output to go "high" for a period equal to $1.1R_1C_1$. During this time, the 1N457 diode is back-biased and a current, determined by the setting of the 200K CALIBRATION control, flows through the meter. At the end of the delay period, the output terminal goes "low" (drops to around ground potential) and removes the blocking bias from the diode. The 1N457 now conducts, forming a low-impedance shunt around the meter.

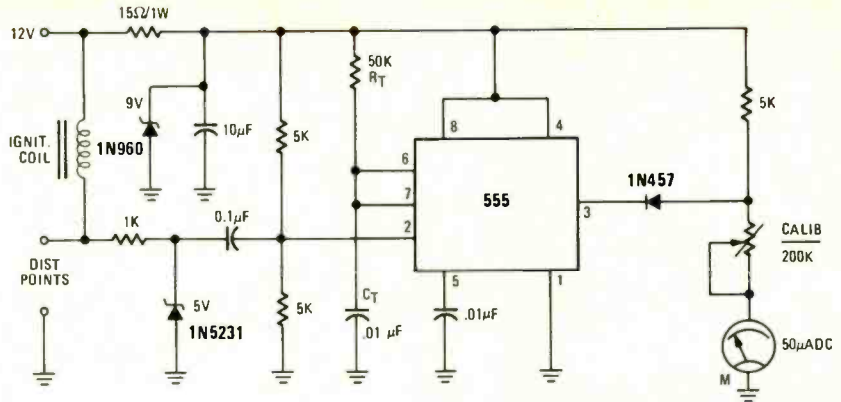

FIG. 13—ELECTRONIC TACHOMETER. Timer processes ignition pulses and controls current flowing through the meter movement.

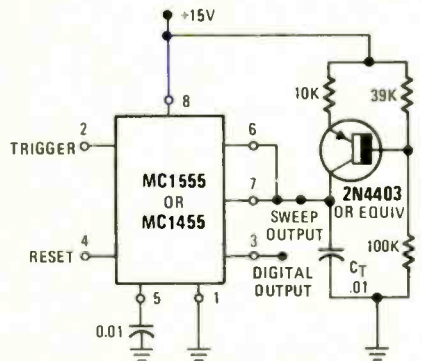

FIG. 10—LINEAR RAMP developed when timing capacitor charges through constant-current source.

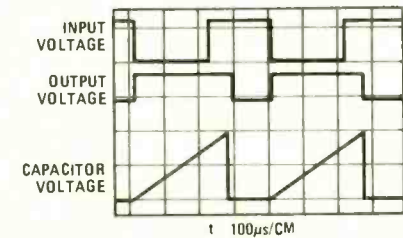

FIG. 11—WAVEFORMS developed in linear-ramp generator.

Non-timer applications

In previously described applications, the timer was used in both the monostable and astable modes for time delay or pulse generations. Another popular application is as a controlled flip-flop. All we need to do is to arrange for the voltage on the trigger terminal to swing from below one-third V_{cc} to a point above two-thirds V_{cc} under some varying outside influence as light, pressure, humidity or temperature. A control relay can be connected from the output terminal to ground or to V_{cc} , depending on the application.

Figure 14 shows how a 555-type timer and an LDR such as a CdS photocell can be used as a photosensitive relay in an intruder alarm or for switching on a light at sunset and off at sunrise. Under normal conditions, the light falling on the photoresistive (or photoconductive) cell causes its resistance to drop to a low value. The voltage on the trigger terminal is equal to one-third V_{cc} or lower, keeping the relay de-energized. As daylight fades, or the light on the photocell is interrupted by an intruder, the photocell resistance rises and the relay is energized to actuate the alarm or

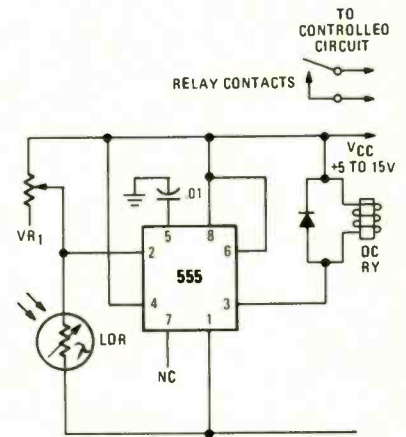

FIG. 14—TIMER CONTROLS RELAY in photoelectric applications. Circuit can be used to control lighting or detect intruders.

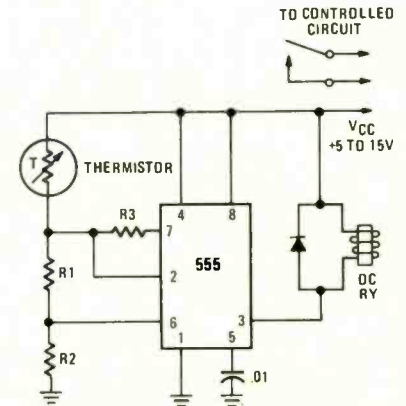

FIG. 15—ELECTRONIC THERMOSTAT can be based on this circuit. Performance depends on thermistor characteristics and on the resistive voltage divider.

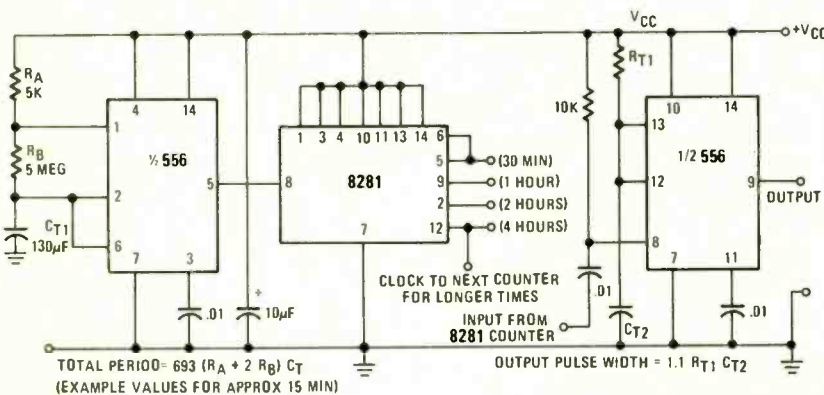

FIG. 12—DUAL TIMER and 8281 presetable binary counter teamed up for long time delays. The delay can be as much as sixteen times that set by the time-constant of the first timer.

From this, we see that the meter is fed a train of current pulses. The meter interprets the ratio of the time that current flows through it to the time that it is removed as revolutions per minute. The best way to calibrate the tachometer is against another of known accuracy. Your local garage will probably have a portable tach and will have one built into their engine analyzer.

turn on a lamp. The variable resistor is a SENSITIVITY control.

Another non-timer use of the 555 is as a thermostat or an interface between a thermistor and a power relay. An application of this type is shown in Fig. 15.

For example, it can be used to turn on a cooling or ventilator fan when the temperature reaches a certain level and turn it off

when the temperature has dropped to a preset low level. Similarly, the circuit might be used to control a heater or oven or, with a lot of refinements, to control the temperature of photo processing chemicals and baths.

The on and off states of the controlled device are determined by the values of R_1 , R_2 and R_3 and on the resistance and temperature coefficients of the thermistor. R-E

Radio-Electronics Tests JVC S-300 Stereo Receiver



LEN FELDMAN
CONTRIBUTING HI-FI EDITOR

YOU HAVE TO TAKE A HARD SECOND LOOK AT JVC's new S-300 to realize that it is, in fact, an integrated receiver. All of JVC's new receivers for 1976-77 have been totally restyled and, in general, resemble the mid-priced unit we tested for this report. As shown in the photo of Fig. 1, the front panel of the S-300 has not a single rotary control on it (unless one counts the edge-mounted thumb-wheel tuning control that resembles a similar tuning treatment popularized by Marantz and still used on that company's tuner and receiver products). The tuning control, isolated on a light colored section of the panel, separates the two main areas of the front panel. The rear sloped AM and FM frequency dials and pointer are highly visible and put an end to having to crouch down to read station frequencies. FM frequencies are linearly spaced, with calibration marks at every half megahertz. Above the dial area, at the left, are twin signal-strength and center-of-channel tuning meters, while at the right are another pair of meters that are actually calibrated to read power output delivered to a pair of 8-ohm speakers. These meters can be used for monitoring output level to insure that speaker power ratings are not being exceeded and to balance the channels. It is most unusual to find a pair of output meters on an all-in-one receiver, since such extras are confined to separate basic power amplif-

iers—and expensive ones at that.

Eleven rectangular pushbuttons are neatly arranged in a single row below the dial area. These take care of power turn on, speaker system selection, program source selection, tape monitoring or dubbing (via the two tape monitor circuits included), FM mute/mono selection and loudness circuit activation. A headphone jack is located along the lower edge of the panel, while a stereo indicator light is centered between the two pairs of meters previously described. The right section of the panel is devoted to what JVC calls its S.E.A. Graphic-Equalizer tone control system. Instead of having bass, treble or even a mid-range tone control, the five slide controls of the graphic equalizer divide the audio spectrum into five sections.

Each control alters response by ± 12 dB at a particular center frequency (see Manufacturer's Specifications) providing a much greater degree of control than is possible with conventional bass or treble controls. Graphic equalizers have become quite popular as separate add-on devices with more sophisticated hi-fi systems but this is, as far as we know, the only all-in-one receiver to incorporate such an elaborate and flexible tone control system. Each lever moves in click-stop increments so that preferred settings of each control are easily duplicated. Above the five graphic equalizer knobs are a pair of

horizontal slide controls that take care of master volume adjustment and channel balance.

The rear panel of the JVC S-300 is shown in Fig. 2. Spring-loaded speaker terminals are provided for each of two possible speaker system pairs, as are switched and unswitched convenience AC receptacles. In addition to the usual phono-jacks for inputs and tape outputs, there is a multi-contact DIN connector (in parallel with the TAPE 2 IN and OUT jacks), an FM DETECTOR output jack (for possible future use with an FM 4-channel



adaptor) and PREAMP-OUT and MAIN AMP IN jacks equipped with wire jumpers that can be removed for separate access to the preamplifier section outputs and the main (power) amplifier inputs. Screw terminals are provided for connection of the AM and FM external antennas, with 75-ohm or 300-ohm options for FM. Before connecting an FM external antenna it is necessary to disconnect a so-called "built in" FM antenna lead from one of the 300-ohm terminals. A ferrite-bar antenna, pivotable away from the chassis, completes the rear-panel layout. The diagram of Fig. 3 illustrates the variety of associated components that can be connected to and used with the S-300 receiver.

The owner's manual of the S-300 does not include a schematic diagram of its circuitry, but careful examination of the internal construction of the receiver (Fig. 4) plus a reading of the company's descriptive literature enabled us to summarize features and construction as follows:

The amplifier section has an input differential stage followed by a Class-A pre-driver. The output stage is a Darlington-connected parallel push-pull fully complementary circuit. The phono preamp section uses a two-stage direct coupled NPN-PNP circuit that is powered by a dual-polarity supply. Protection circuitry includes a speaker circuit relay, DC voltage detector and a speaker safety circuit covered by two U.S. patents. A new four-resonator type single-unit ceramic filter is used in the IF section, along with a

MANUFACTURER'S PUBLISHED SPECIFICATIONS

FM TUNER SECTION:

IHF Usable Sensitivity: 1.9 μ V (10.96 dBf), 50 dB Quieting Sensitivity: mono, 3.5 μ V (16.3 dBf); stereo, 40 μ V (37.4 dBf). **Harmonic Distortion** 1 kHz: mono, 0.2%; stereo, 0.4%. **Signal-to-Noise Ratio:** mono, 70 dB; stereo, 60 dB. **Selectivity:** 60 dB. **Capture Ratio:** 1.2 dB. **Image Rejection:** 70 dB. **AM Suppression:** 50 dB. **Stereo Separation:** 1 kHz, 45 dB; 10 kHz, 30 dB.

AM TUNER SECTION:

Sensitivity: internal antenna, 300 μ V/M; external antenna, 30 μ V. **Signal-to-Noise Ratio:** 55 dB. **Selectivity:** 30 dB. **Image Rejection:** 45 dB. **IF Rejection:** 50 dB.

AMPLIFIER AND PREAMPLIFIER SECTION:

Power Output: 50 watts/channel continuous into 8-ohm loads, 20 Hz to 20 kHz at no more than 0.3% total harmonic distortion. **IM Distortion:** 0.3% at rated output. **Damping Factor:** 50 at 8 ohms. **Input Sensitivity:** phono, 2.5 mV; high level, 180 mV. **Signal-to-Noise Ratio (A Weighted):** phono, 70 dB; aux and tape, 95 dB. **Phono Overload:** 200 mV. **Phono Frequency Response:** RIAA ± 0.5 dB. **Tone Control Center Frequencies:** 40 Hz, 250 Hz, 1 kHz, 5 kHz, 15 kHz. **Control Range:** ± 12 dB.

GENERAL SPECIFICATIONS:

Dimensions: 19-11/16" wide \times 6-5/16" high \times 13-3/16" deep (50W. \times 16H. \times 33.5D. cm.) **Net Weight:** 22.9 pounds (10.39 Kg). **Suggested Retail Price:** \$400.00

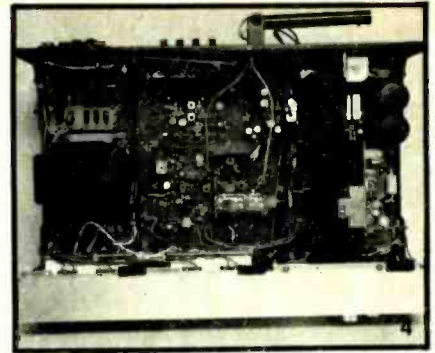
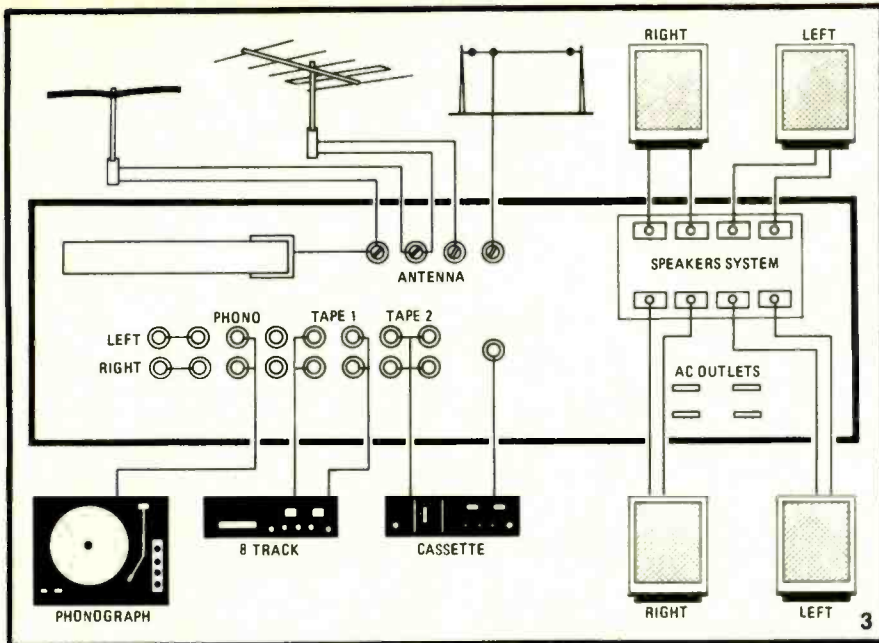

μV (25.4 dBf), by which time distortion is down below 1.0% and noise is better than -40 dB. Muting threshold is set to almost the same point (9 μV , or 24.5 dBf), but it should be noted that when listening to stereo it is impossible to defeat the muting circuitry. JVC probably reasoned that weaker signals would not be listenable in stereo anyway, so they combined the mono/stereo FM mode switch with the mute defeat switch on one pushbutton. Measured 19 kHz and 38 kHz rejection (with no filter connected at the output) was 60 dB. All in all, JVC engineers have managed to squeeze quite a bit of FM performance out of an economical circuit that is designed into this receiver.

quadrature FM detector circuit and a phase-locked-loop multiplex section. The entire AM circuitry is contained in a single multipurpose IC. The FM front-end of the S-300 uses a 3-gang capacitor and a dual-gate MOSFET RF amplifier stage. High-voltage (output stage) supplies (negative and positive) are filtered by means of a pair of 10,000 μF capacitors.

FM tuner measurements

Laboratory measurements of the tuner section of the S-300 are summarized in Table I. Sensitivity readings in mono and stereo are typical for a three-section tuning arrangement in the front end, though 50 dB quieting in mono is better than we would have expected, at 2.5 μV (13.4 dBf). Maximum S/N ratios in both mono and stereo were outstandingly good and, in each case, considerably better than claimed by the manufacturer. We suspect that JVC may have "counted in" the residual sub-carrier product output in specifying only 60 dB of quieting in the stereo mode, when, in fact, the new IHF measurement specs permit the use of a low-pass filter (with cut-off set at 15 kHz) when making S/N measurements. While both mono and stereo THD figures were lower than claimed (at 1 kHz), we were surprised to note that the THD in stereo was actually lower than that measured in mono. This is contrary to what usually happens when we measure THD in both FM reception modes and can only be explained as some sort of distortion cancelling that occurs in two circuit regions which result in a single lower overall figure when measured at the output of the multiplex section. Frequency response follows the required de-emphasis quite closely out to beyond 10 kHz, but dips a bit too quickly (in an effort to minimize sub-carrier output products, no doubt) so that response at 15 kHz (the end of the useful audio spectrum in FM) response is attenuated some 1.5 dB more than it should be.

Secondary specifications such as selectivity, image and IF rejection were not as high as on some more expensive sets but were certainly adequate for most listening situations. Stereo separation, while not quite as high at mid-frequencies as the 45 dB claimed

by JVC, manages to remain above 30 dB all the way out to 10 kHz and is a more than sufficient 41 dB at 1 kHz. Stereo switching takes place at an input signal strength of 10

TABLE I
RADIO-ELECTRONICS PRODUCT TEST REPORT

Manufacturer: JVC

Model: S-300

FM PERFORMANCE MEASUREMENTS

	R-E Measurement	R-E Evaluation
SENSITIVITY, NOISE AND FREEDOM FROM INTERFERENCE		
IHF sensitivity, mono: (μV) (dBf)	2.1 (11.8)	Good
Sensitivity, stereo (μV) (dBf)	10.0 (25.4)	Good
50 dB quieting signal, mono (μV)	2.5 (13.4)	Excellent
50 dB quieting signal, stereo (μV)	40.0 (37.4)	Average
Maximum S/N ratio, mono (dB)	74.0	Excellent
Maximum S/N ratio, stereo (dB)	71.0	Excellent
Capture ratio (dB)	1.2	Very good
AM suppression (dB)	53.0	Good
Image rejection (dB)	73.0	Average
IF rejection (dB)	75.0	Average
Spurious rejection (dB)	88.0	Good
Alternate channel selectivity (dB)	60.0	Good
FIDELITY AND DISTORTION MEASUREMENTS		
Frequency response, 50 Hz to 15 kHz (\pm dB)	1.5 dB	Average
Harmonic distortion, 1 kHz, mono (%)	0.14	Very good
Harmonic distortion, 1 kHz, stereo (%)	0.08	Superb
Harmonic distortion, 100 Hz, mono (%)	0.17	Very good
Harmonic distortion, 100 Hz, stereo (%)	0.08	Superb
Harmonic distortion, 6 kHz, mono (%)	0.17	Very good
Harmonic distortion, 6 kHz, stereo (%)	0.18	Excellent
Distortion at 50 dB quieting, mono (%)	1.0	Average
Distortion at 50 dB quieting, stereo (%)	0.3	Excellent
STEREO PERFORMANCE MEASUREMENTS		
Stereo threshold (μV) (dBf)	10.0 (25.4)	Good
Separation, 1 kHz (dB)	41.0	Very good
Separation, 100 Hz (dB)	35.0	Good
Separation, 10 kHz (dB)	30.0	Very good
MISCELLANEOUS MEASUREMENTS		
Muting threshold (μV) (dBf)	9.0 (24.5)	Fair
Dial calibration accuracy (\pm kHz @ MHz)	100	Excellent
EVALUATION OF CONTROLS, DESIGN, CONSTRUCTION		
Control layout		Excellent
Ease of tuning		Fair
Accuracy of meters or other tuning aids		Very good
Usefulness of other controls		Excellent
Construction and internal layout		Very good
Ease of servicing		Very good
Evaluation of extra features, if any		Excellent
OVERALL FM PERFORMANCE RATING		
		Very good

TABLE II
RADIO-ELECTRONICS PRODUCT TEST REPORT

Manufacturer: JVC

Model: S-300

OVERALL PRODUCT ANALYSIS

Retail price	\$400.00
Price category	Medium
Price/performance ratio	Excellent
Styling and appearance	Very good
Sound quality	Very good
Mechanical performance	Excellent

Comments: The truism which suggests that the high-fidelity component of today offers greater dollar value than ever before certainly applies to this totally redesigned receiver from JVC. The graphic-equalizer section of this receiver, if bought as a separate component, would be worth fully half the asking price of the entire S-300, and its incorporation in this relatively low-priced integrated receiver is an outstanding accomplishment. From a cosmetic standpoint, we suspect that shoppers will either love the new JVC look instantly or will be completely turned off by it. The inveterate knob twirler will find the knob-less front panel a bit difficult to get used to. The only rotating control to be found on the S-300, the edge mounted tuning knob, is a rather crude imitation of the edge-tuned thumbwheel long featured in Marantz tuners and amplifiers and is not nearly as easy to use as its progenitor. Incorporation of direct-reading power meters on a unit in this price class is also most unusual and welcome.

While the amplifier section "measures" a bit better, overall, than the tuner section, actual listening tests posed no problems either with FM, stereo FM or phono disc and tape reproduction. For all the pushbuttons provided, we would have thought it possible to separate the mute function from the mono/stereo FM switch, since, in its present configuration, it is not possible to listen to stereo FM without engaging the muting function—a combination which may frustrate some FM DX'ers who want to scan the dial for everything they can pick up regardless of its noise content.

50 watts of audio per channel, conservatively rated as in the JVC S-300 receiver, is enough power for most hi-fi system applications wherein the user does not expect to produce ear-shattering loudness levels from inefficient speaker systems, and the \$400.00 price tag of this well executed receiver places it within the budget of a great number of first and second-system owners who want a receiver that offers tonal compensation facilities not ordinarily found in an all-in-one unit.

Amplifier and preamplifier measurements

Table III shows results of measurements made of the preamplifier and power amplifier sections of the JVC S-300 receiver. From the consistently high power output obtained even at the low-frequency extreme (54 watts at 20 Hz, compared with a mid-frequency output of 58 watts for rated 0.3% THD), one can judge that the power supply arrangement in the receiver is well regulated and conservatively designed. At its rated output of 50 watts per channel (into 8 ohms) at mid-frequencies, THD measured a low 0.065%. IM, though not quite as low at 0.18%, was well below its rated 0.3% figure. There is absolutely no indication of notch or crossover distortion with this receiver and distortion continues to get lower with decreasing power outputs until it becomes too difficult to read because of noise content that begins to represent appreciable contribution to the single reading when measuring THD for low power output levels.

Phono input sensitivity measured close to the 2.5 mV claimed, and based upon that input sensitivity, signal-to-noise in phono (unweighted) was an impressive 71 dB. Since JVC quotes S/N figures on the basis of an "A" weighting curve, we repeated the S/N measurements with such weighting applied and obtained readings of 78 dB in phono, 97 dB for the high level inputs and 102 dB for residual noise (with volume control at minimum)—all excellent results for a receiver at any price. Overload capability of the phono section was 220 millivolts.

(continued on page 120)

Empire 2000Z Cartridge

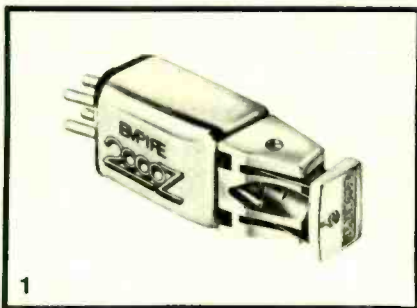

EMPIRE SCIENTIFIC CORPORATION'S NEW MODEL 2000Z cartridge, shown in Fig. 1, is that company's highest quality pickup in their popular 2000 series which includes cartridges ranging in price from around \$30.00 (for the

model 2002) to \$100.00 for the 2000Z. The new cartridge boasts tighter frequency response specs and better tracking capability and separation than their previous top model, the 2000EIII. In physical format, it differs slightly from the other models in the 2000 series in that its removable stylus assembly (the entire forward part of the cartridge) is equipped with a pivotable stylus guard that can be rotated downward to cover the exposed stylus tip. In this regard, it more closely resembles the 4000 series cartridges offered by Empire.

Cartridge construction

Not shown in Fig. 1 is the simple mounting bracket with which all Empire cartridges are secured in place and properly positioned in a pickup arm of a turntable system. The

bracket has two projecting lips that slip under the metal shield of the cartridge at the rear and a projecting dimple at the front that pops neatly into place. This provides the correct downward angle for the entire cartridge housing as referenced to the horizontal plane of the holder. The bracket has the advantage of permitting to user to mount it (by means of screws provided) into a pickup arm headshell while the cartridge body itself is safely off to the side away from possible accidental damage by screwdrivers or nervous fingers.

Few audio enthusiasts realize just how complex a quality phono cartridge really is, and what precise tolerances are required in its manufacture. Twenty seven precision parts are pictured in a blow-up diagram of a typical phono cartridge made by Empire in their excellently illustrated product brochure. The 2000Z uses four coils, pairs of which are wound in opposite directions to cancel induced hum voltages. Three separate magnets are used. The rear magnet (located behind the coils) generates the primary magnetic field while the two front magnets help to equalize magnetic flow when the stylus is motionless thereby preventing microphonics. Four precision poles serve to guide and concentrate the magnetic flow in the gap in which the light-mass hollow iron armature varies magnetic flow as it is moved by the stylus affixed at the other end of the cantilever tube. A compliant elastomer suspension

MANUFACTURER'S PUBLISHED SPECIFICATIONS:

Frequency Response: 20 Hz to 20,000 Hz, ± 1 dB. **Tracking Force Range:** 0.75 to 1.25 grams. **Separation:** 20 dB from 20 Hz to 500 Hz; 30 dB from 500 Hz to 15 kHz; 25 dB from 15 kHz to 20 kHz. **IM Distortion:** Less than 0.08%, 2 kHz to 20 kHz @ 3.54 cm/sec stylus velocity. **Stylus:** 0.2 x 0.7 mil diamond. **Effective Tip Mass:** 0.2 milligrams. **Compliance:** Lateral: 30×10^{-6} cm/dyne; Vertical: 30×10^{-6} cm/dyne. **Tracking Ability:** 0.9 grams for 38 cm/sec at 1 kHz; 0.8 grams for 30 cm/sec @ 400 Hz. **Channel Balance:** within 0.75 dB @ 1 kHz. **Tracking Angle:** 20°. **Recommended Load:** 47,000 ohms. **Required System Capacitance:** 300 pF. **Output Level:** 3.0 mV at 3.54 cm/sec. **DC Resistance:** 1100 ohms. **Inductance:** 675 mH. **Type Of Cartridge:** moving iron. **Suggested Retail Price:** \$100.00

element is used for accurate positioning of the stylus.

Laboratory measurements

Empire's published frequency response is based upon measurements made using a CBS 100 test record. Since that test record was introduced to the industry several years ago, a newer and more accurate set of test records has been developed by CBS and, in our tests, we used an STR-130 test record by CBS which was recorded using precise RIAA equalization. Our results, shown in Fig. 2, are almost identical with those published in Empire's literature and, if anything, show somewhat less of a rise in amplitude as one approaches the 20-kHz frequency extreme. So good was the response to 20 kHz, in fact, that we decided to use a JVC-TRS-1005 test record that has test frequencies recorded out to 50,000 Hz (and is intended for checking out CD-4 type phono pickups). Although the 2000Z was never intended to be used as a discrete CD-4 playback cartridge, we were surprised to find that at 30 kHz, response was down only 4 dB (relative to 1000 Hz response) and at 40 kHz response was down some 13 dB. Whatever resonance there was (and it amounted to less than 2 dB) showed up at a frequency of 25 kHz.

Using the CBS STR-112 tracking-ability test record we determined that compliance (both lateral and vertical) equalled 30×10^{-6} cm/dyne, exactly as claimed. Velocities of 38 cm/sec were tracked with minimal distortion with a downward tracking force of one gram. This velocity is probably higher than any you are likely to encounter in playing commercially recorded musical records.

Output level for a 3.54 cm/sec velocity was 3.0 mV for one channel, 3.2 mV for the other, indicating extremely good balance between channels. Separation (also plotted in Fig. 2)

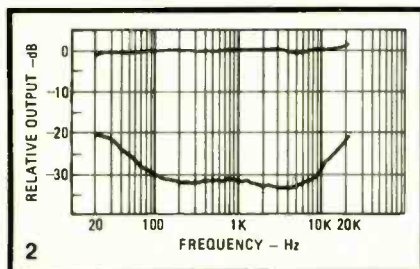

measured over 30 dB at mid frequencies and remained well over 25 dB at 10 kHz.

Summary listings of our laboratory measurements for the Empire 2000Z are given in Table I. It should be noted that all tests were conducted with a carefully measured loading capacitance of 320 pF (a bit higher than the nominal recommended 300 pF value listed by Empire). We cannot stress the importance of correct capacitive loading of a cartridge enough, especially when dealing with a cartridge that has the potential performance of this one. The capacitance consists of the audio cable capacitance plus the lower capacitance of the tiny wires within the pickup arm of the turntable system, plus the input capacitance of the phono preamplifier circuit. With insufficient capacitance applied in parallel with the cartridge output, a rising characteristic will be obtained. With too much capacitance, high frequency response will be attenuated noticeably.

TABLE I RADIO-ELECTRONICS PRODUCT TEST Manufacturer: Empire Scientific Corp. PHONOGRAPH CARTRIDGE MEAS'		
FREQUENCY RESPONSE (Hz-kHz, \pm dB)		
STEREO SEPARATION Separation, 1 kHz (dB)	32	Very
Separation, 10 kHz (dB)	28	
CHANNEL BALANCE 1 kHz (dB)	0.2	Excellent
TRACKABILITY MEASUREMENTS		
Stylus velocity at 1 kHz (cm/sec)	38	Excellent
Lateral compliance (cm/dyne)	30×10^{-6}	Excellent
COMPONENT MATCHING CHARACTERISTICS		
Output level, 1 kHz, 3.54 cm/sec (mV)	3.1	
Optimum load impedance (ohms)	47,000	
Tracking force range (to grams)	0.75-1.25	
OVERALL PHONO CARTRIDGE RATING		Excellent

TABLE II RADIO-ELECTRONICS PRODUCT TEST REPORT Manufacturer: Empire Scientific Corp. Model: 2000Z		
OVERALL PRODUCT ANALYSIS		
Retail Price	\$100.00	
Price Category	High	
Price/performance ratio	Excellent	
Sound Quality	Excellent	
Mechanical performance	Very good	
<p>Comments: Like a loudspeaker system, the phono cartridge is a transducer. Instead of converting electrical energy into mechanical energy, it does just the reverse. Transducers are that special category of hi-fi components that have traditionally been presented to the buying public shrouded in vague and often meaningless accompanying performance specifications. To a large degree, this is because there has been little agreement as to how to measure and report performance—particularly in the case of speakers. While the situation is not nearly as bad when it comes to phono cartridges, few manufacturers have bothered to clearly spell out specifications that aid the consumer in making the right selection. Happily, Empire now seems to have changed all that. Their new format of specification listing tells us all we want and need to know about a phono pickup. More importantly, our tests confirmed that the specs are honestly and conservatively reported and our ears confirmed the correlation between good specs and good sound. The Empire 2000Z offers extremely smooth response in the audible range and, even at the light tracking force (1.0 grams) at which our listening tests were conducted, never failed to track the grooves of even our most dynamically recorded musical test passages. Highs were silky smooth, never "edgy" or raspy and there was not even a hint of "peakiness" in the important 12,000 to 16,000 Hz range where so many other pickups often add distinct and easily identifiable coloration. We found that mounting of this cartridge is easily accomplished, thanks to the separate bracket that can be affixed to the pickup arm separately, after which the cartridge body is simply snapped into place. Hum level was noticeably lower for this cartridge than that heard with cartridges lacking Empire's hum-bucking coil construction and extensive shielding. In short, the new Empire 2000Z is a top-of-the-line pickup that should appeal to audio enthusiasts who seek extreme accuracy of reproduction, low tracking force and excellent tracking characteristics.</p>		

All of our tests were conducted using Empire's newly developed model 698 turntable system. The pickup arm of this turntable has a vertical and horizontal bearing friction of less than .001 grams. To realize the full potential of a cartridge such as the Empire 2000Z, it is important that the pickup be used in conjunction with a high-quality turntable system that can accommodate such low tracking-force cartridges and is also

equipped with an accurate and stable anti-skating force adjustment.

Our overall comments regarding the Empire 2000Z, along with a summary product evaluation will be found in Table II. With the introduction of the 2000Z, Empire Scientific Corporation has taken an important step forward in the often difficult realm of transducer development. For the audiophile, this cartridge is worth its price. R-E

The better the training the better you'll

Send for
FREE
illustrated
career
guide

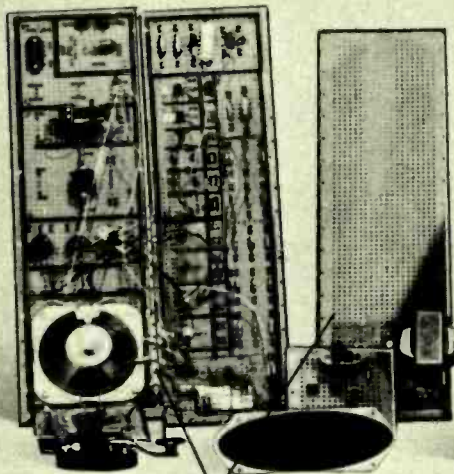
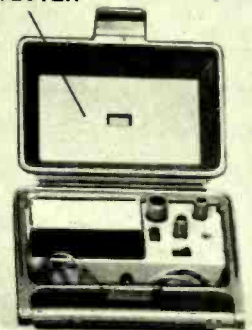
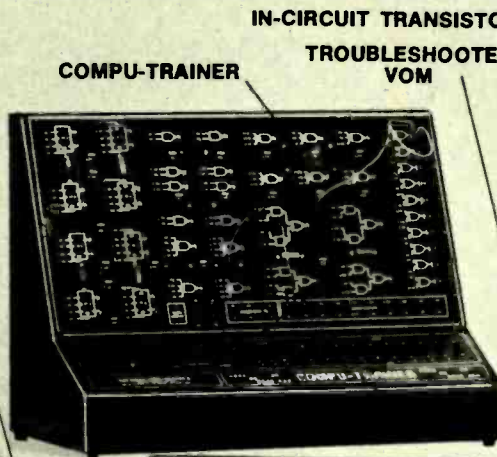
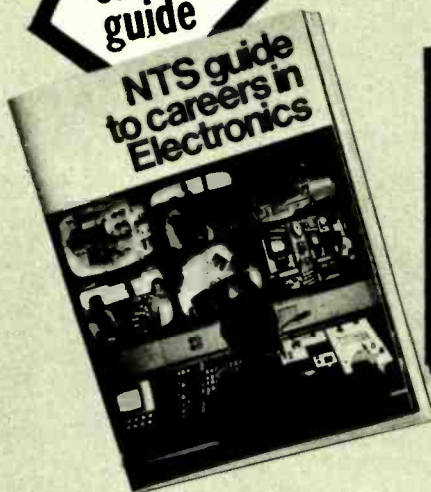

ELECTRO-LAB

(Simulated TV Reception)

As an NTS student you'll acquire the know-how that comes with first-hand training on NTS professional equipment. **Equipment you'll build and keep.** Our courses include equipment like the **NTS/Heath Digital GR-2000 Solid State color TV** with first-ever features like silent varactor diode tuning; digital channel selection, (with optional digital clock), and big 315 sq. in. ultra-rectangular screen.

Also pictured above are other units — 5" solid state oscilloscope, vector monitor scope, solid-state stereo AM-FM receiver with twin speakers, digital multi-meter, and more. It's the kind of better equipment that gets you better equipped for the electronics industry.

This electronic gear is not only designed for training; it's field-type — like you'll meet on the job, or when you're making service calls. And with NTS easy-to-read, profusely illustrated lessons you learn the theory behind these tools of the trade.

Choose from 12 NTS courses covering a wide range of fields in electronics, each complete with equipment, lessons, and manuals to make your training more practical and interesting.

Compare our training; compare our lower tuition. We employ no salesmen, pay no commissions. You receive all home-study information by mail only. All Kits, lessons, and experiments are described in full color. Most liberal refund policy and cancella-

and the equipment be equipped.

**COMPARE OUR
KITS AND LESSONS.
COMPARE OUR
TUITION.**

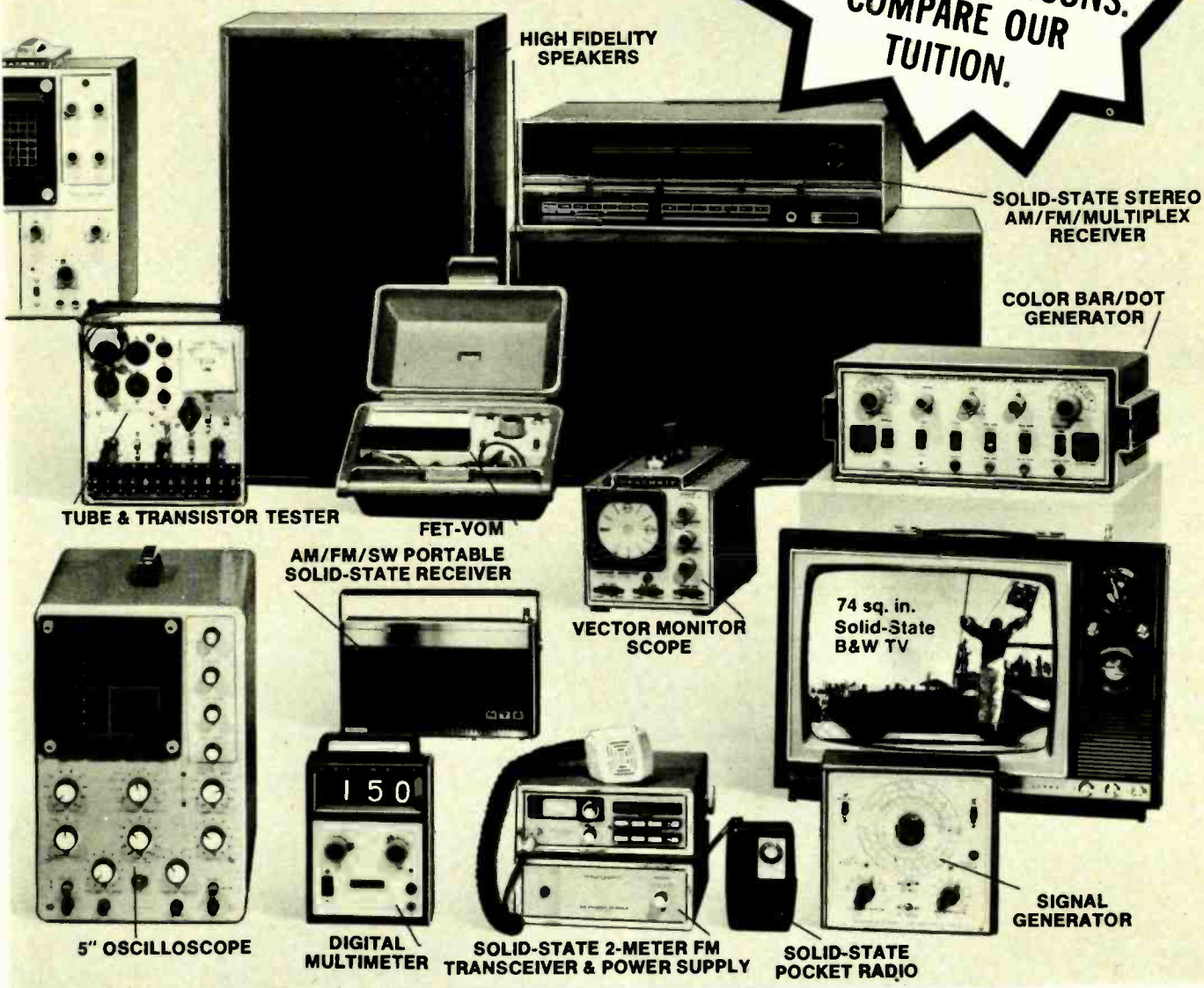

tion privileges spelled out. Make your own comparisons, your own decision. Mail card today, or clip coupon if card is missing.

NO OBLIGATION. NO SALESMAN WILL CALL

APPROVED FOR VETERAN TRAINING

Get facts on new 2-year extension

NATIONAL TECHNICAL SCHOOLS

TECHNICAL-TRADE TRAINING SINCE 1905
Resident and Home-Study Schools
4000 So. Figueroa St., Los Angeles, Calif. 90037

NATIONAL TECHNICAL SCHOOLS

4000 South Figueroa St., Los Angeles, Calif. 90037

Dept. 206-096

Please send FREE Color Catalog and Sample Lesson.
NO OBLIGATION. NO SALESMAN WILL CALL.

- Color TV Servicing
- B & W TV and Radio Servicing
- Electronic Communicators
- FCC License Course

- Electronics Technology
- Computer Electronics
- Basic Electronics
- Audio Electronics Servicing

NAME _____ AGE _____

ADDRESS _____ APT # _____

CITY _____ STATE _____

Please fill in Zip Code for fast service _____

- Check if Interested in G.I. Bill Information.
- Check if interested ONLY in classroom training in Los Angeles.

Calibrating with

New frequency calibration method that is of Standards involves the use of an ordinary

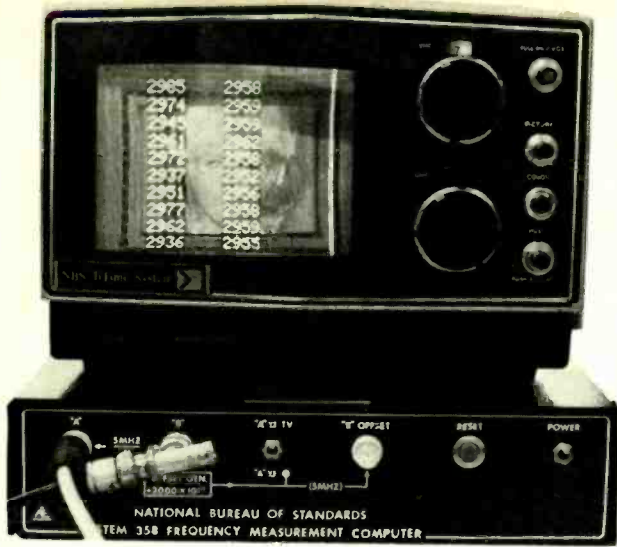

FREQUENCY CALIBRATION WITH GREATER accuracy than most people need is now possible using a system developed by the National Bureau of Standards. The system is based on the characteristics of network color television broadcasts and yields more accurate and quicker results than those obtainable using the NBS radio stations—WWV, WWVH or WWVB.

To accurately measure the frequency of an oscillator or to set it to a predetermined frequency, some means of comparison is required. This is not unlike measuring a distance or constructing your own ruler or micrometer. For the ruler to be very accurate, some means of comparing it to the national standard of length is needed.

Taking the ruler to the standard is usually difficult and taking the standard to the ruler is usually impossible. Some means of transferring a measured length, directly comparable to the standard length, is required. This transfer standard can be a precision "ruler" that is characterized and calibrated by the NBS. This hypothetical ruler comes with data describing how its length changes with temperature and other environmental influences and with data indicating how accurately it was cali-

brated. From this information, the accuracy of this transfer standard ruler can be calculated.

Frequency measurement usually involves some kind of a transfer standard. The international units for time and frequency (the second and the hertz) are defined in terms of atomic phenomena (see box). The oscillator used to generate the standard is shown in Fig. 1. It is difficult to compare an oscillator to the NBS Cesium standard (not the least difficulty being the long drive for most people to Boulder, Colorado). Many schemes have been devised that make it possible to compare an oscillator to transfer standards that are themselves carefully compared to the NBS standard. Three of these schemes are the flying clock, the NBS radio broadcasts and the new television subcarrier transfer system.

Transfer standards

The flying clock is a portable version of the Cesium atomic standard that can be carried aboard an aircraft to any location in the world. This is the most accurate system yet devised and is used to compare the national standards of different

countries to each other. Since few people need this accuracy or can afford the cost (the portable standard has a price tag of close to \$20,000), other methods are used for mass distribution.

Standard-frequency radio broadcasts are the most popular of the transfer standards. The NBS radio stations are located near Fort Collins, Colorado (WWV and WWVB) and Kekaha, Kauai, Hawaii (WWVH). The information and services provided by the broadcasts include standard time and frequency, standard audio tones, seconds broadcasted as ticks, BCD time-code and voice announcements for time, storm information, radio propagation forecasts and geophysical alerts. WWV and WWVH broadcast on 2.5, 5, 10, 15 and 20 MHz. WWV also broadcasts on 25 MHz. WWVB broadcasts on 60 kHz and transmits only a time code. Its VLF (Very Low Frequency) carrier is affected much less by propagation factors than the HF (High Frequency) carriers of WWV and WWVH.

All time-signals, tones and carrier frequencies of the three stations are controlled by Cesium atomic oscillators that are regularly compared to the national standard (see Fig. 2). This precision at the transmitter, however, does not guarantee equivalent precision at the receiver. Effects due to the changes in the propagation medium cause fluctuations in the received frequencies. While transmitted frequencies are held to better than 2 parts in 10^{11} (0.0002 Hz at 10 MHz), the received frequency stability of WWV is no better than 1 part in 10^7 (1 Hz at 10 MHz) when averaged for 10 minutes. The VLF signals of WWVB are good to 1 part in 10^9 (0.00001 Hz) when averaged for 2 to 8 hours. This really isn't too bad for experimenters and amateur radio operators; after all, most common quartz crystals are only calibrated to 0.01% (1 part in 10^4). However, when measuring frequencies in the UHF or microwave regions or setting clock oscillators, more accuracy is often required.

The new television subcarrier transfer system offers this increased accuracy and,

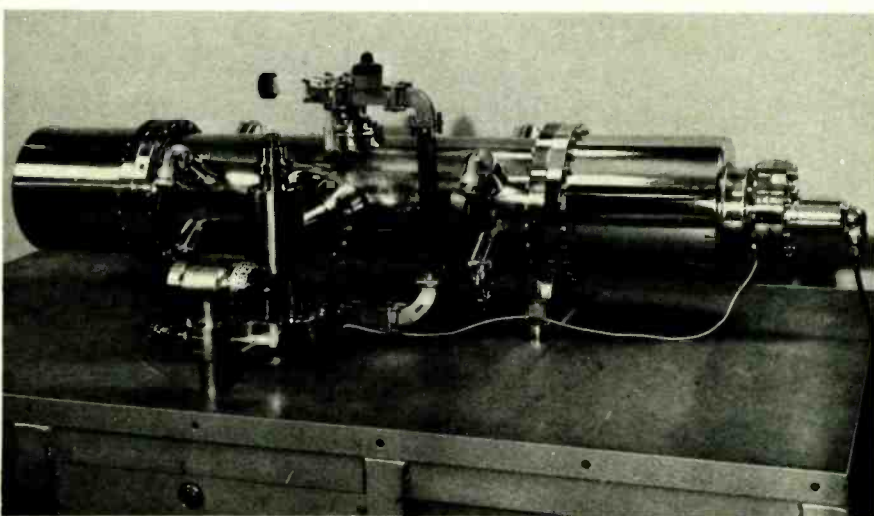

FIG. 1—CESIUM BEAM ATOMIC FREQUENCY STANDARD at the National Bureau of Standards.

Frequency Your TV

directly traceable to the National Bureau of Standards television receiver and an external device

MICHAEL S. ROBBINS

as a bonus, costs less and is quicker to use than most other systems. The transfer standard in this system is the Rubidium atomic oscillator used by the networks to generate the 3.58-MHz color subcarrier. These Rubidium oscillators are in use by the three commercial networks in both New York and Los Angeles and by PBS in New York. If you're not in New York or Los Angeles, don't stop reading! Almost every network show, including those on tape, with the exception of live sports events, has a color subcarrier generated by a Rubidium oscillator. Every program, whether it comes to you via satellite, microwave relay or coaxial cable contains this same color subcarrier practically undistorted by its travels through the bowels of the telephone company and the void of outer space. And, most importantly, every 3.58 crystal oscillator in every television receiver tuned to one of these network shows, in New York, Los Angeles or at the end of CATV cable system in a mountain village, is phase locked to that network Rubidium oscillator! This system is also applicable to those parts of Canada and Mexico that receive U.S. network programs.

Think of it! Every color television set, even that old clunker that you're about to throw out, has an oscillator good to 1 part in 10^{11} (0.00001 Hz) when averaged for only 15 minutes.

TV transfer system

Figure 3 shows how the 3.58 MHz and

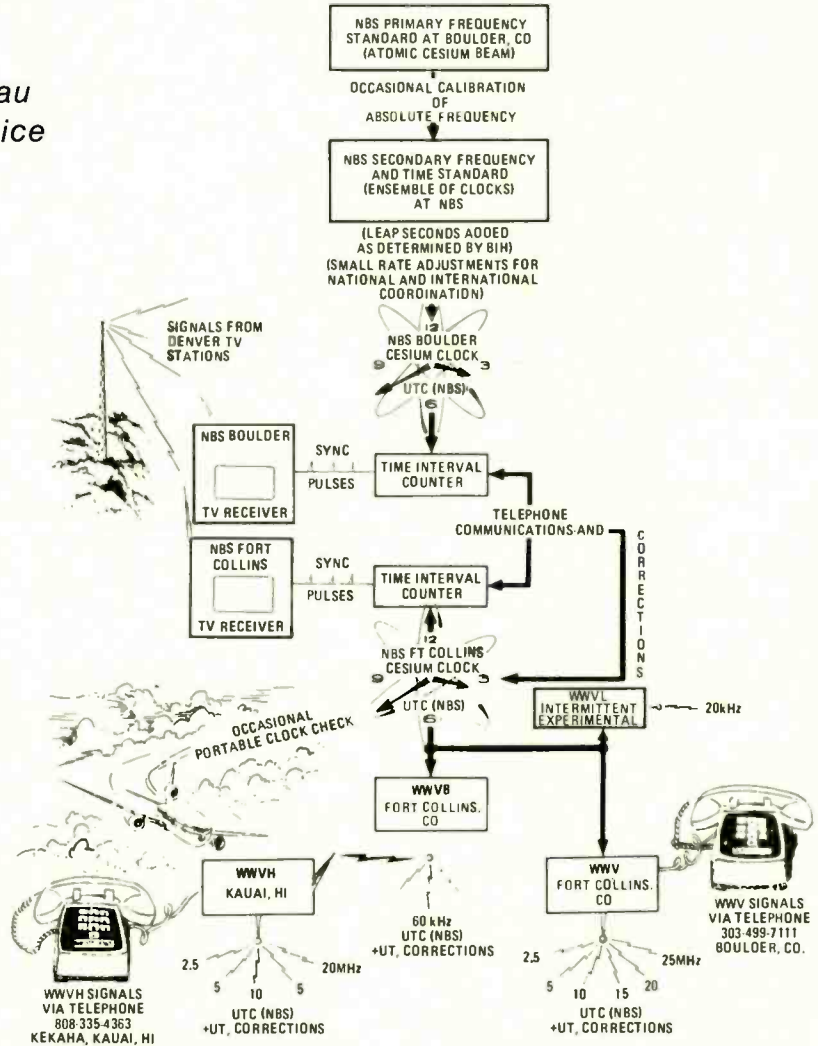

FIG. 2—FREQUENCY AND TIME FACILITIES of the National Bureau of Standards.

the vertical and horizontal synchronization pulses are derived from the 5 MHz Rubidium oscillators. A similar scheme can be used to generate a 3.58 MHz signal from a 5 MHz oscillator in any shop or

lab which can then be compared to the 3.58 MHz oscillator in the TV set. Figure 4 shows how this might be done.

There is a quirk in the system that can be both a help and a hindrance. The network Rubidium oscillators are not exactly at 5 MHz. This is not to say that they are varying all over the place; far from it! International definitions and standards have changed since the networks purchased their equipment and it is now offset from the NBS standard by about 300 parts in 10^{10} low (written -300×10^{-10}). The exact value of this offset including any drift produced by other effects is measured daily by the NBS and published in its free monthly services bulletin. The offset itself facilitates the use of the subcarrier in this measurement system, while the

THE SECOND REDEFINED

A joint experiment between NPL (England) and the U.S. Naval Observatory from 1955-58 determined the cesium transition frequency in terms of the second. "The duration of 9,192,631,770 periods of the radiation corresponding to the transition between two hyperfine levels of the ground state of the cesium 133 atom" defined the second. This definition, replacing the astronomical definition of a second, has been used by the NBS since 1960, and was internationally adopted in 1967 by the 13th General Conference on Weights and Measures. Since 1967, the world's unit of time interval, the second, has therefore been defined by using atomic devices and not by astronomical observatories.

NBS measurements and their publication make your results traceable to NBS.

It is a requirement in every measurement system to have some degree of traceability if a given measurement is to have any validity when compared to measurements made at other times or in other places. Traceability to NBS is a requirement for measurements made to FCC specifications. This system offers traceability to NBS and measurement precision greater than that available using most other methods.

Three different types of equipment have been devised to make use of the technique. All three compare the phase of the received color subcarrier to the oscillator being measured.

The most elegant of the three is the

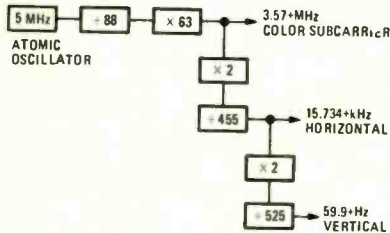

FIG. 3—COLOR TV SYSTEM FREQUENCIES are derived from an atomic oscillator by using a combination of frequency multipliers and dividers.

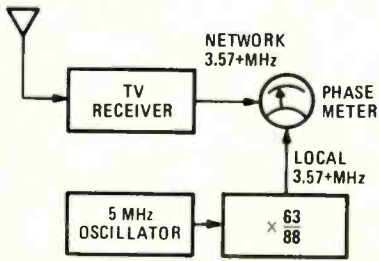

FIG. 4—PHASE COMPARISON permits calibration of oscillator to network color sub-carrier.



FIG. 5—NBS SYSTEM 358 COMPUTER displays frequency difference between network's Rubidium oscillator and local signal.

NBS System 358 Frequency Measurement Computer shown in Figure 5. This unit automatically computes the difference between the networks rubidium oscillator (5 MHz minus offset) and your oscillator and displays it digitally on its TV screen. When your oscillator is exactly at 5 MHz, the number on the screen will be equal

to the published offset. After ten readings are displayed in the left-hand column, their average will be displayed in the right-hand column. A total of ten averages can be displayed for a total of 100 measurements. Any reading that falls outside preset limits (the "window") is rejected and therefore does not skew the average. These rejected values may result from in-

TV set's chroma circuit and is displayed on the TV screen as a vertical color bar. A block diagram is shown in Fig. 6.

If the oscillator being calibrated is at the precise frequency of the network oscillator, the bar will be stationary and its color will not change. This, however, is not the desired situation as the network oscillators are offset from the NBS stan-

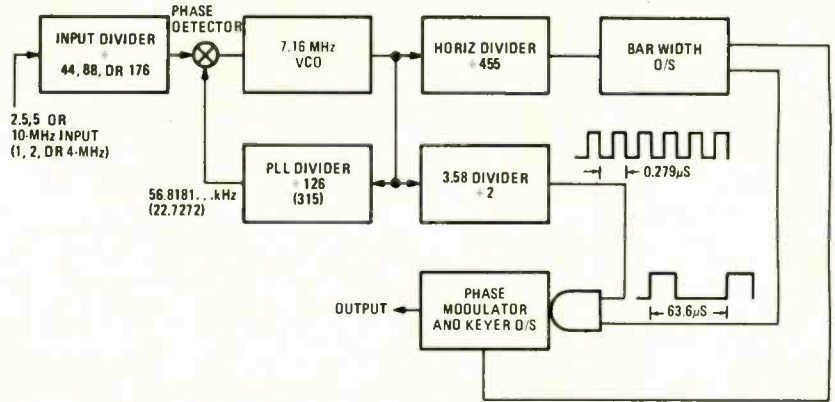

FIG. 6—COLOR-BAR frequency comparator system.

terference or program changes.

The System 358 Frequency Measurement Computer can also be used to compare two oscillators to each other. This is often valuable, especially in the absence of network programs. The unit is available in wired or kit form from Astro Engineering. Complete circuit details are available from the NBS.

Another unit is the Model 1011 Frequency Comparator manufactured by Arbiter Systems. It contains its own television front-end, IF and chroma demodulator circuits. Offsets from the NBS bulletin are entered on thumbwheel switches and measured results are displayed on digital read-outs. The unit sells for about \$3000.00.

Color-bar comparator

The most economical, though slightly less precise, method involves the use of



FIG. 7—DYNATRON MODEL 175 frequency comparator displays color-bar on the screen of an ordinary receiver.

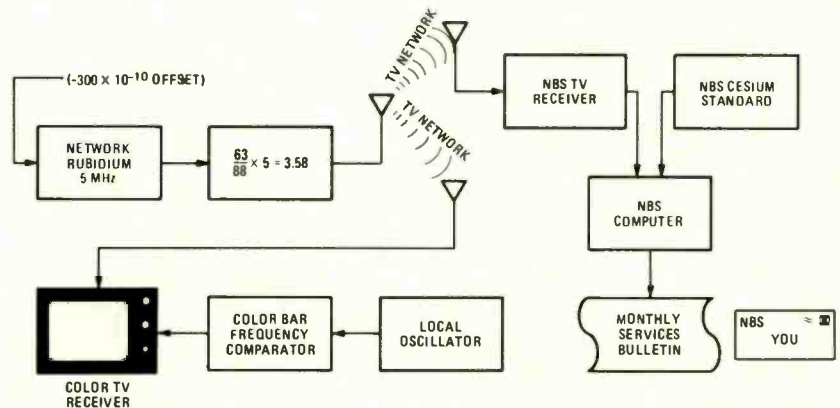

FIG. 8—CALIBRATION SYSTEM using the color-bar frequency comparator.

a color-bar frequency comparator and an ordinary color television receiver. The comparator synthesizes a 3.58 MHz signal from the signal fed into it. A horizontal pulse rate is derived from the 3.58 MHz and used to gate the 3.58 MHz to the output. This pulsed 3.58 MHz is fed into the

dard by approximately 300 parts in 10^{10} low (written -300×10^{-10}). To compensate for this offset, the oscillator being calibrated should be adjusted so that the rainbow appears to move from right to left through a complete color cycle in

(continued on page 108)

Step-by-step TV Troubleshooters Guide

Vertical sweep circuits are basically simple, but their problems may not be. Here's how to troubleshoot them

JACK DARR
SERVICE EDITOR

THE VERTICAL SWEEP CIRCUITS OF A tube-type color TV look very simple. Basically they are, but there can be problems. Let's see how this circuit works; it is very well adapted to step by step troubleshooting methods.

One circuit has almost become a standard in tube-type color sets. It's the multivibrator oscillator. Figure 1 shows a typical circuit. For identification purposes, let's call the left hand tube the "input" and the right one the "output". Most sets, especially later models, use a tube designed for this circuit. The input half is a voltage amplifier triode and the right half a power amplifier pentode.

If you'll look closely at Figure 1, you'll see that this is actually a two-stage R-C coupled audio amplifier. It could be the driver and power output stage of a hi-fi amplifier. We take the signal from the plate of the output tube and feed it back to the input through a dropping and shaping network of resistors and capacitors. It arrives at the input in just the right phase to make the circuit oscillate. With this kind of feedback, the circuit has to oscillate *if all the parts are good*. This is one of the key points in the troubleshooting procedure. If the circuit refuses to oscillate, you've still got a bad part in there somewhere.

The circuit is free-wheeling—it does not depend on the presence of sync pulses to work. Sync pulses are fed into the input stage, at various points. You can feed a positive-going pulse to the grid of the input tube, a negative-going pulse to the grid of the output tube, etc. The sync is often fed to the plate of the input tube through the coupling capacitor. This pulse is amplified by the output tube and fed back to the input grid.

The time-constant that determines the frequency of oscillation depends on the values of the coupling capacitor between input and output, and the grid resistor of the output stage or the grid resistor of the input stage. So, we can control the frequency by making part of this grid resistance variable.

The operation of this circuit depends

on the charging of the grid capacitor. This takes place when the DC voltage is applied to the plate of the input tube. When this capacitor has charged up to the desired voltage, it is discharged by the input tube being driven into conduction. This action is triggered by the sync pulse. Note the gradually rising waveform on the input grid. If the HOLD control is rotated so that the picture rolls slowly downward, you'll see the vertical sync on this waveform. It will be a tiny pip on the curved part. You will be able to see the picture lock-in momentarily when the sync-pip gets to the top of the waveform. This fires the input tube, discharges the capacitor and develop a sawtooth voltage on the output tube grid.

The output stage amplifies and shapes this pulse, and feeds a more or less rectangular pulse to the output transformer. This pulse is fed to the vertical windings of the deflection yoke via the output transformer. The inductance of the yoke converts the rectangular pulse into a sawtooth wave of *current*. The sawtooth wave is required to obtain a linear vertical sweep.

There are three controls—the vertical HOLD control varies the grid resistance of the input stage, the vertical SIZE or HEIGHT control varies the plate voltage of the input stage, and the vertical LINEARITY control varies the grid voltage of the output stage. These are adjusted to make the raster full and linear. There are some pitfalls here; we'll go over them in a minute.

In the "old original" circuit as used in black-and-white TV, the cathode of the output tube was bypassed with an electrolytic capacitor. The cathode resistor was a low-resistance variable, the ends were connected to cathode and ground so that the resistance remained the same. The bypass capacitor was connected to the slider—this changed the amount of the cathode resistor that was bypassed. The *gain* of the output stage was varied by changing the amount of cathode degeneration. With the capacitor at the cathode end, the stage has maximum gain; at the ground

end, minimum gain. This was used as the vertical LINEARITY control. Remember this "effect." We're going to see it used in a slightly different way but with the same basic principle.

Troubles

There are several kinds of different problems that show up in this circuit. One, of course, is a loss of vertical sweep. The symptom is a bright horizontal line on the screen. The appearance of this line will give you a clue to location of the trouble. If it's very thin, only one or two scanning lines high, the cause is usually something in the output stage—an open winding in the vertical deflection yoke or vertical output transformer, dead output tube, loss of supply voltage to the output stage, or a bad connection between the vertical output transformer secondary and the yoke.

If the horizontal line is thicker, say about an inch high or so, the cause of the trouble is more apt to be something in the input stage. What little deflection you see is due to some stray 60-Hz pickup on the open grid of the output section. Loss of the DC supply voltage to input stage, open coupling capacitor between input and output, open plate load resistor of the input stage, open vertical SIZE control, bad tube and similar things. If the feedback loop is completely open, the symptom will be much the same.

Another problem that can develop is sweep distortion. If the raster is short, or the linearity is bad, you'll see that the scanning lines are either too far apart or crowded together. This shows up at the top of the picture in most cases. The top of the picture may even be folded over so that you can see some of it upside down and backwards. Problems like this are mostly caused by something in the output stage. Incorrect bias, open cathode bypass capacitor or leakage in the coupling capacitor between input and output. This allows too much positive voltage to get through to the output grid and causes foldover and non-linearity.

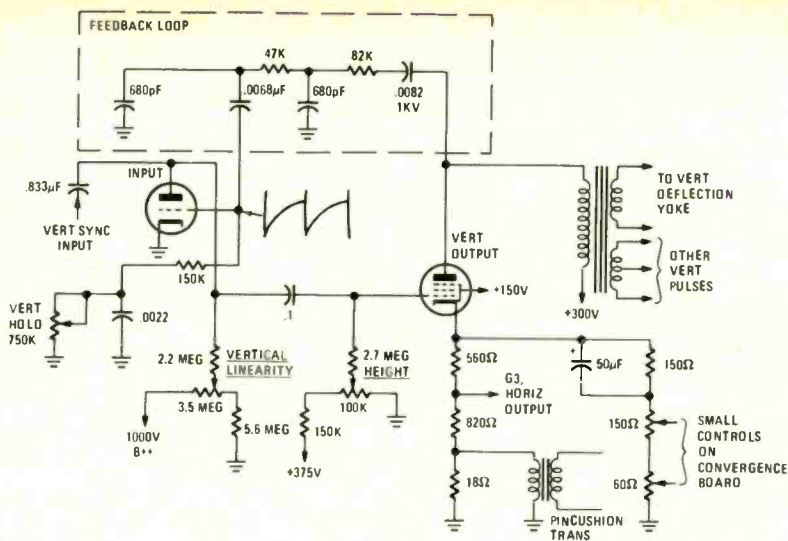

FIG. 1.—TYPICAL CIRCUIT of vertical output and oscillator stage. Tube will probably be special triode-pentode.

Misadjustment of the vertical SIZE and LINEARITY controls can cause non-linearity, short sweep and even fold-over if they're far enough off. The correct method of adjustment is to turn both SIZE and LINEARITY controls until you shrink the raster by about an inch both top and bottom. Adjust both of these controls until the raster is linear. (You'll find that they can affect the vertical hold and the picture will roll. This is normal. Stop the picture by setting the vertical hold control and continue the adjustment.)

A crosshatch generator is very handy for easy checking of linearity. You can also do it by looking at the scanning lines; get them evenly spaced all the way up. To finish up, move both controls until the raster covers the screen, and is overscanned top and bottom by not more than half an inch. This is important; if the raster is stretched too far at the top, this will affect the grid waveform shape and it will actually show up as a case of vertical sync trouble! The waveform distortion makes it hard for the sync to trigger the oscillator at the proper time.

One or two more things. If the raster isn't centered in the first step, adjust the vertical centering control until it is. Also, note that in Fig. 1 the control in the plate of the input half is marked LINEARITY and the control in the output half grid is HEIGHT (or SIZE, interchangeable). In quite a few sets, you'll find the same controls with the names reversed! Actually, this doesn't make much difference. They do the same things and both must be adjusted to set the raster up properly. Finally, the vertical adjustments must be made before any dynamic convergence is attempted. Reason: these adjustments change the shape of the vertical pulses used in the convergence circuitry. Adjust these after convergence and you'll

have to do the convergence over!

Stretching or compression of the scanning lines near the center of the screen (not at the top) is generally due to a few shorted turns in the primary or secondary of the vertical output transformer. Shorted turns in one half of the vertical windings of the deflection yoke will make the raster "keystone." The small end of the keystone will point to the shorted half of the yoke.

Vertical sync problems

If you have a linear raster that fills the entire screen and the vertical HOLD control will make it roll up or down, holding the raster somewhere near the center of rotation of the HOLD control, this is *not* due to a problem in the vertical oscillator or output stages! You have lost too much amplitude in the vertical sync. To check this move the HOLD control until the picture is rolling slowly down. Watch the blanking bar between the pictures. When this reaches a point about two inches or more from the bottom of the screen, it should suddenly snap in and hold temporarily. Check this action on a working TV set; it's a key clue to the presence or absence of vertical sync.

There is a peculiarity in the action of the vertical HOLD control. Its normal action is like this; turning it one way (usually clockwise) should make the picture roll slowly downward with the "snap" at the bottom. Turning it the opposite way should leave the picture stationary for quite a while, then it will break out of sync very suddenly and move upward rapidly. For identification, we say that a picture moving down is "rolling" and moving up is "flipping." This type of action is due to the shape of the grid waveform on the input stage and the timing of the sync pulse.

A good check is turning the HOLD

control to the flipping side and checking the reaction. If you find that you can move the picture slowly upward, you have no vertical sync at all! Don't waste time checking the vertical oscillator or vertical output stages, go to the sync-separator stage. Vertical sync works on amplitude, horizontal sync on phase. So if there is a problem in the sync separator, the vertical sync is always the first one that shows up.

There is another somewhat similar problem but with a different cause. This is the one where the vertical HOLD control will stop the picture but it's all the way to one end or the other of its rotation. You may not be able to make it flip or roll though it will hold fairly well. Normally you should be able to stop the picture with the hold control somewhere near the center of its rotation. This is generally due to a drift in the value of the fixed resistor in series with the vertical HOLD control, the 150K in Fig. 1.

You can check to see which way it went. If your vertical HOLD control is set at maximum resistance, this resistor is now too small. Change it to 180K and see if this will let your HOLD control center again. If the hold control is at minimum resistance, the fixed resistor is too large—try using a smaller one, say 120K. This will not have too much affect on the circuit operation but will give you better centering of the HOLD control. In very rare cases, this can be caused by a minute leakage in the capacitors in the grid circuit. If the resistor won't stop it, check them by replacement.

As we said in the beginning, this circuit can be broken down into two major sections—the two-stage audio amplifier and the feedback loop. In most cases, trouble in the amplifier stages will upset the height, linearity etc. while troubles in the feedback loop will upset the frequency but leave the raster comparatively linear.

One good test for this is to open the feedback loop. Disconnect the .0068-μF capacitor from the input grid. Now feed a test signal into the grid of the output stage. This can be any low voltage at 60 Hz; the heater voltage of the tube itself if this isn't a series-string type set. If you see that this does cause some vertical deflection, usually about half of a full raster, with a decided "barrel shape" (due to the sine-wave signal instead of the sawtooth), the output stage is working. Now go to the grid of the input stage and feed in the same signal. Due to the greater gain, you should obtain much more deflection. If you do, the amplifier stages are working and you have pinned the cause of the trouble down to something in the feedback loop. Check all resistors and capacitors in there.

When you boil it down, this is a very

a spike waveform, but only about 25 to 30 volts P-P.

Additions to basic circuit

The circuit shown in Fig. 1 is a representative sample of what you'll see in practically all tube and hybrid color TV sets. There will be quite a few variations, but the basic reactions will still be there. You'll find different part values, tubes, voltages, and so on. In some sets you'll even find added parts. Some of these will be little R-C networks to ground, these are called "saw-formers" and aid in shaping the waveforms properly. Check these if you have distortion problems.

Unusual troubles

The vertical output stage in color TV sets isn't as simple as the one mentioned earlier. This is especially true of the vertical output *cathode* circuit. In the black-and-white TV, this consisted of one variable resistor and a big capacitor. The one used in color sets is quite a bag of worms! This can cause problems in troubleshooting simply because we don't think of the cathode circuit as a possible cause! Trace out this circuit in Fig. 1. Leaving the cathode, we go through a small resistor then through a couple more to ground. This is one branch. On the cathode, an R-C circuit is connected to the convergence circuitry through two controls. You may find additional components in more complex circuits.

The purpose of all this is to provide vertical frequency pulses for use in the convergence circuits, or for vertical blanking, etc. The tap between the 560 ohm and 820 ohm resistors, though, is used to provide a small DC voltage. This is applied to the suppressor grid of the *horizontal* output tube to suppress snivets. However, a shorted horizontal output tube can damage the lower two resistors, and thus make trouble in the *vertical* circuits! The last tap is used to feed a pulse to the pincushion transformer. Here again, trouble in the pincushion transformer can upset the vertical circuits.

The problem here is that when the other circuits are defective, they upset the *bias* on the vertical output stage. So, check out *all* of the different branches and make sure that they're not affecting the vertical output. One way to check is to measure the cathode voltage. This should be somewhere around 35-40 volts. Another way is to check the cathode waveform. This should be something of a parabola with fairly sharp spikes, about 35-40 volts P-P.

One common cause of "freak" symptoms is that little electrolytic capacitor in the cathode circuit. This will run from 50 to 100 μ F at about
(continued on page 110)

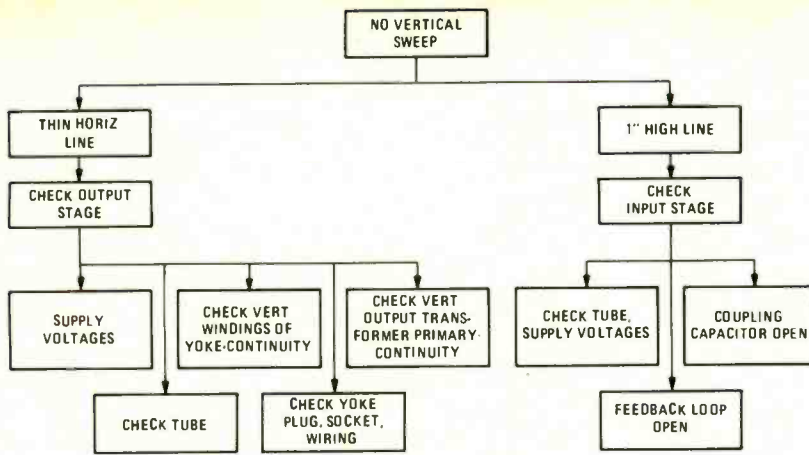

TROUBLESHOOTING CHART—No vertical sweep.

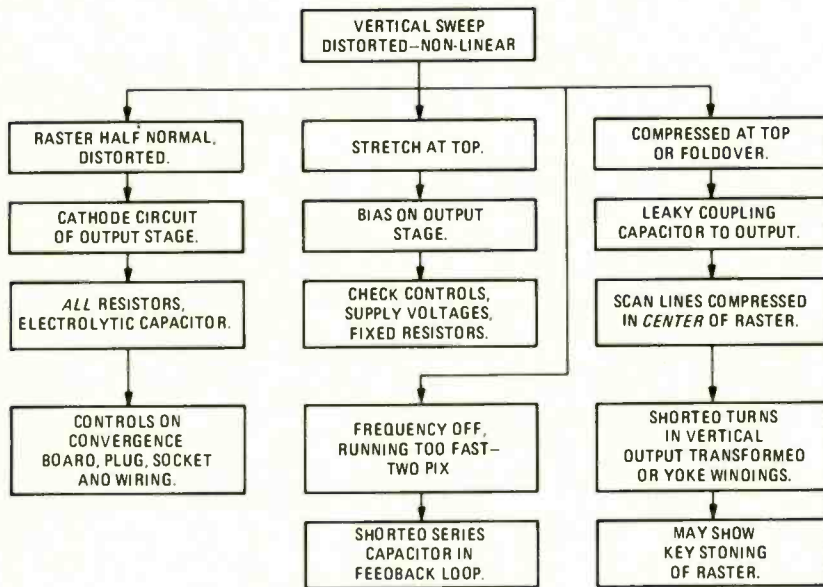

TROUBLESHOOTING CHART—Distorted vertical sweep.

simple circuit. It uses only a few resistors and capacitors! However, they are all critical. Any drift in the resistors or leakage in the capacitors is going to upset circuit operation. Check capacitors for leakage by disconnecting them. Now hook your VTVM or FETVM, set to DC volts, to one end and touch the other end of the capacitor to a high DC voltage. You will see a kick reading. Due to the very high impedance of the voltmeter, this may stay up for some time. You can discharge the capacitor by touching the probe and chassis with a fingertip. The reading should fall to zero. If it climbs back up again, even to only one volt DC, this indicates too much leakage! Try this on a known good capacitor and you'll see how it works. When replacing capacitors, always use the best you can get, with at least a 600 working-voltage rating. Also, never substitute a different size capacitor! Use exactly the same value used in the original.

The "do not measure" point

Note that the plate of the output tube is always marked "Do Not Measure" on schematics. This is due to the presence of a very high transient voltage during normal operation. This is big enough to break down scope probes and unprotected DC voltmeters, it averages around 1400 volts peak. To read the plate voltage of this tube, take your reading at the bottom of the primary winding on the B+. Then, turn the set off and read the resistance of the primary winding. If both of these are normal, you do have plate voltage on the tube and you can go on to other tests. If you're careful, you can check for the spike voltage by holding the scope probe close to, but *not* touching, the plate connection or transformer lead. You will get enough capacitive pickup to see it.

Another way is to check the waveform on the vertical output transformer *secondary*, on the hot lead to the vertical windings of the yoke. This will be

build a digital countdown timer

PART II

A versatile countdown timer with keyboard programming that can control various external devices. The time interval can be programmed in increments of one second from one second to approx. 11,000 years

GEORGE R. BAUMGRAS



THE FIRST PART OF THIS ARTICLE (August, 1976) presented the schematic diagram and a description of the digital countdown timer.

This second and concluding part of the article presents the board layouts and the construction details.

Construction

All of the circuitry, the display and the

keyboard were mounted on 6 printed-circuit boards and assembled in a custom-made cabinet measuring 5" high \times 8½" wide \times 6" deep, affording plenty of room for wiring, switches, the relay and the transformer. Wire-wrap sockets were used for the displays and the TTL IC's so that connections could be soldered on both sides of the board where required and component re-

placement would be easy. All connections between boards were made with No. 22 stranded and color-coded wire, and No. 12 was used between the relay and the AC outlet. The line cord connects directly to the relay common-terminals and should be rated at 10 amps minimum.

The only components that require selective purchase are the discrete transistors, other than Q3. Both the silicon NPN and PNP types are rated at 40V (B_{VCE}), 600 mA (I_C), should have a current gain (β) of at least 80 and a

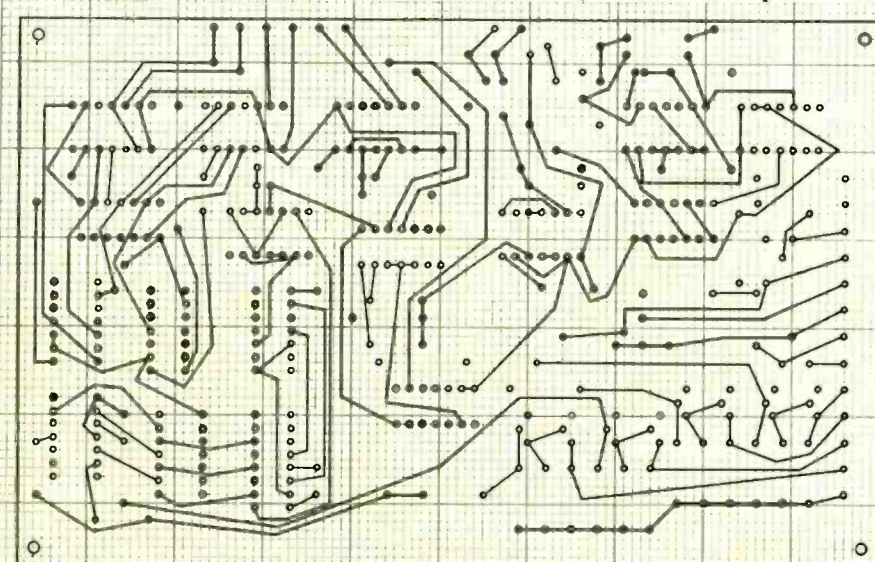

CONTROL BOARD, view of bottom side of double-sided board. Grid is 10 lines per inch.

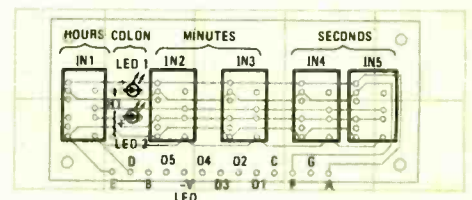

NOTES:

1. ALL PARTS LOCATED ON COMPONENT SIDE
2. WIRE WRAP SOCKETS EXTENDING 2" ABOVE BOARD REQUIRED TO PERMIT SOLDERING
3. CUT OFF SOCKET PINS 4, 9, 12 AND 14.

DISPLAY BOARD, view of component side of board with components shown. Layout may be used to generate PC board or perforated board. Grid is 10 lines to the inch. Actual board size is 4" \times 17." (10.2 cm \times 4.3 cm).

CONTROL BOARD (top left), view of component side of double-sided board with component placement. Layout may be used to make printed-circuit board of perforated board. Actual board size is 4" x 6.4" (10.2 cm x 16.3 cm). Grid is 10 lines-per-inch.

ALARM BOARD (middle left), view of component side of board with components shown. Layout may be used to generate PC board or perforated board. Grid is 10 lines to the inch. Actual board size is 3" x 1.5" (7.6 cm x 3.8 cm).

CALCULATOR BOARD (bottom left), view of component side of double-sided board with component placement. Grid is 10 lines per inch. Layout may be used to generate printed-circuit board or perforated board. Actual board size is 4" x 6.4" (10.2 cm x 16.3 cm).

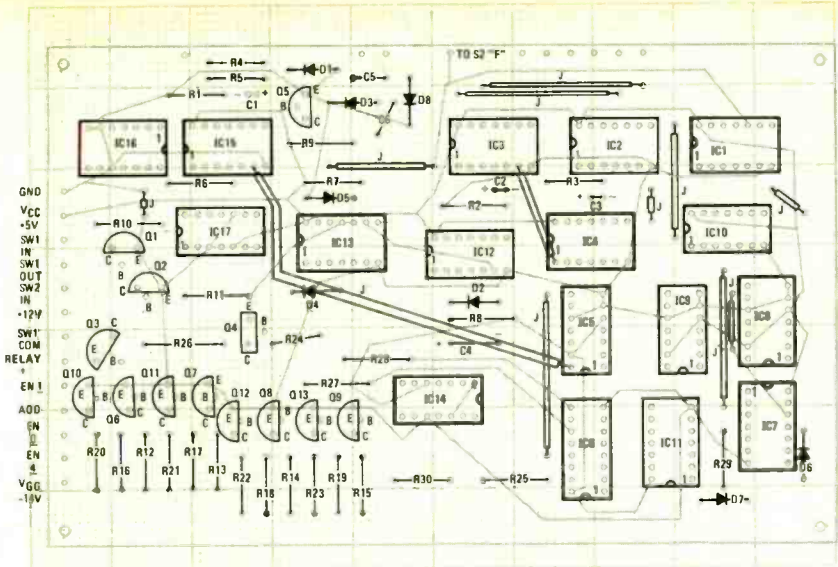

- NOTE:
1. ALL PARTS THIS SIDE
 2. WIRE WRAP SOCKETS EXTENDING 2" ABOVE BOARD REQUIRED TO PERMIT SOLDERING BOTH SIDES.
 3. INSTALL JUMPERS AS SHOWN-INSULATE AS REQUIRED. PIN TO PIN JUMPERS SHOULD BE ON OTHER SIDE.

This mode of construction lets you lay out and make your own circuit boards. Note: Our artist goofed on some boards and drew some IC pins too far apart. Just make sure that the IC terminal pins fall exactly on consecutive one-tenth inch line intersections and all else will work out OK.

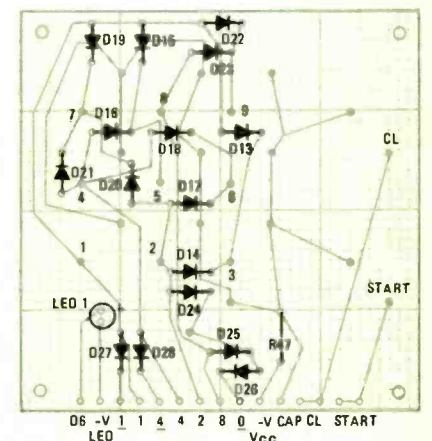

- NOTE:
1. HOLES MARKED ● CONNECT TO AND LOCATE BODY OF DAK #415 SWITCHES.
 2. UNDERLINED NUMBERS CONNECT TO CONTROL CIRCUIT BOARD. "OVER" LED CONNECTIONS ARE TO BE LOCATED PER SWITCH BODY PATTERN, REPLACING DECIMAL POINT KEY NORMALLY USED.
 3. RESISTOR AND DIODES LOCATED ON BOTTOM SIDE-SWITCH BODIES ARE MOUNTED ON COMPONENT SIDE OF BOARD.

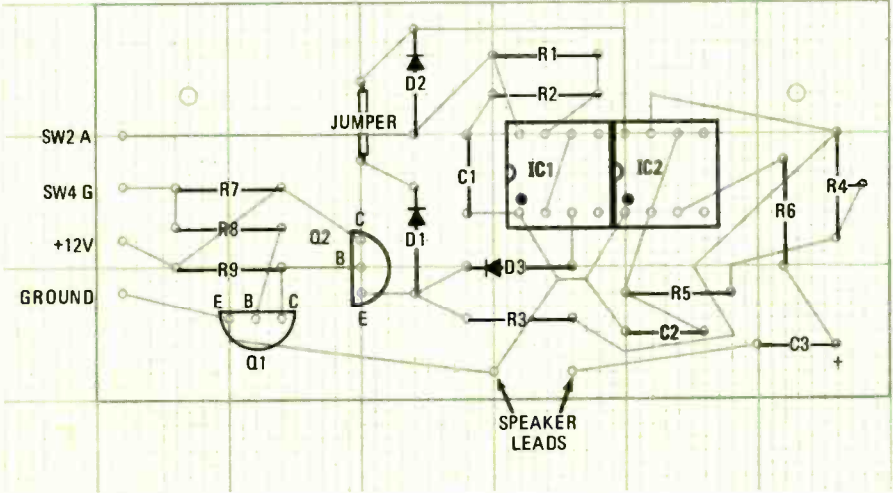

KEYBOARD, view of component side of board with components shown. Layout may be used to generate PC board or perforated board. Grid is 10 lines to the inch. Actual board size is 4" x 4" (10.2 cm x 10.2 cm).

TO-92 case. Those used in the prototype appear to be house numbered, the NPN type being marked M311 and similar to a 2N3904 or 2N2222. The PNP's were marked M236 and similar to MPS6563 or HEP716. Suitable equivalents should be available from surplus outlets for around 20¢ each. These two transistor-types are used throughout the design and each was tested before use. Two of the NPN units that appeared to be matched were selected during testing and used as Q39 and Q40 in the calculator clock circuit shown in Fig. 2. All of the IC's, diodes and resistors were also checked and although not a single bad part was found, the effort was considered worthwhile since a malfunction would be difficult to track down once the total package is put together.

Where a more complex timing func-

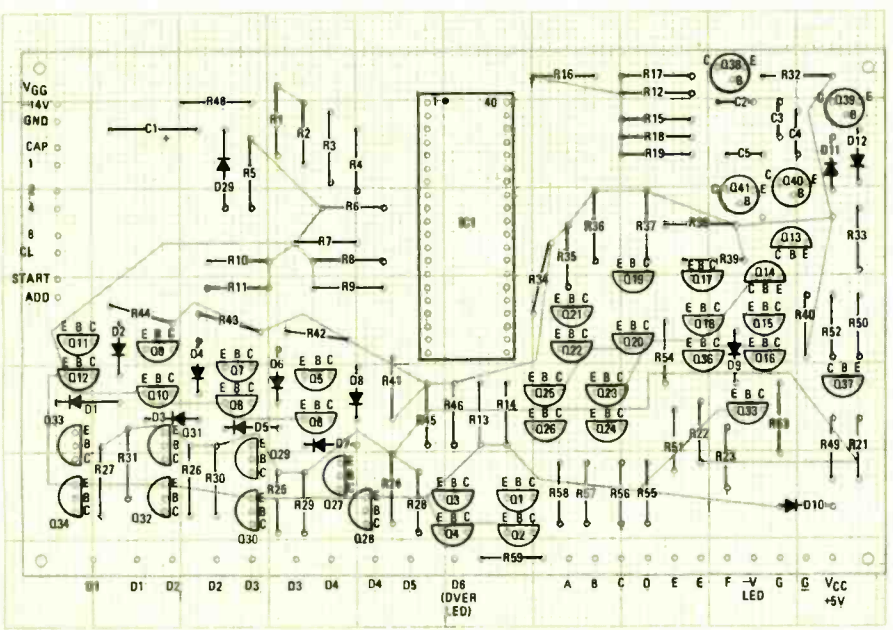

FREE EICO CATALOG

358 Ways To Save On Instruments, Citizens Band, Burglar Alarms, Automotive & Hobby Electronics!

The more you know about electronics, the more you'll appreciate EICO. We have a wide range of products for you to choose from, each designed to provide you with the most pleasure and quality performance for your money. The fact that more than 3 million EICO products are in use attests to their quality and performance.

"Build-it-Yourself" and save up to 50% with our famous electronic kits.

For latest EICO Catalog and name of nearest EICO Distributor, check reader service card or send 50¢ for fast first class mail service.

EICO—283 Malta Street,
Brooklyn, N.Y. 11207

Leadership in creative electronics
since 1945.



Circle 64 on reader service card

tion is demanded, several additional modes are possible. For example, the terminals of switch S2, instead of operating an alarm, can be rewired to provide +12 volts at 30 mA to two receptacles on the rear panel; thus initiating either of two external functions. A third receptacle interfaced with the START input will permit remote, sequential, or automatically controlled triggering of the countdown process. A similar input to the CLEAR function can be used for remote or emergency turn-off, and the normally-closed contacts of the relay could also be brought out to the rear panel. In a darkroom applica-

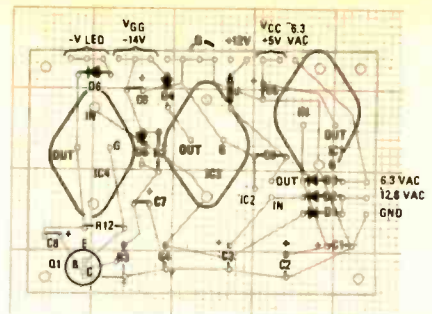

POWER SUPPLY BOARD, view of top of single-sided board. Actual board size is 4.25" X 3" (10.8 cm X 7.6 cm.) Grid is 10 lines to the inch. Layout can be used to generate PC board.

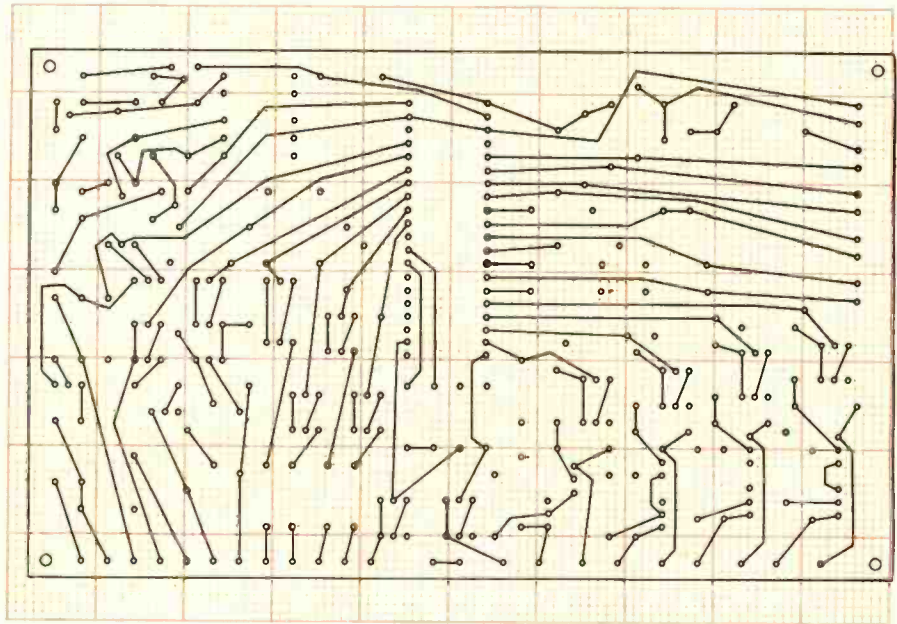

CALCULATOR BOARD, view of bottom side of double-sided board. Grid is 10 lines per inch.

tion, the normally-closed relay contacts can be used to control the safelight while the enlarger is controlled by the normally-open relay contacts. Thus the

safelights will be switched off when the enlarger is on, and vice versa. Probably many other adaptations of the basic scheme will become obvious. **R-E**

BRIGHTNESS CONTROL HAS NO EFFECT

Turning the brightness control on this Philco 22QT79 has no effect. I'd welcome any help.—S.E., Norfolk, VA.

Look in the cathode circuit of the 12GN7 video-output tube. (A little crowded in there, isn't it? There are *three* different controls all in the circuit!) First is the PICTURE-PEAKING, next the CONTRAST, and finally the BRIGHTNESS. The BRIGHTNESS control finally returns to the +20 volt source. See diagram.

The brightness control has one end tied to the slider. Moving this varies the voltage on the 12GN7 cathode, and so changes the bias that in turn changes the brightness. I'd say that it was quite possible that the slider contact on the control was either open or shorted to one end of the control.

Alternate possibility is that the +20-

volt supply is not correct. Be sure that it's present on the low end of this con-

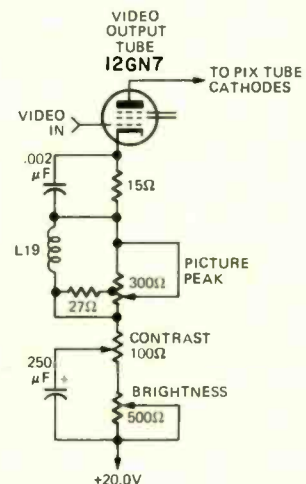

trol and then check to make sure that the control does vary the voltage.

How 2½ Million Smart Buyers Get Superior Quality CB and Hi-Fi Equipment at Lower Prices.



- Citizens Band
- Cameras
- Calculators
- Hobby Kits
- Watches And Clocks
- Test Equipment
- Electronic Parts And Accessories
- Musical Instruments
- Security Systems
- Power Tools
- Stereo Components
- Radios
- Ham Gear
- Scanners
- TV Accessories
- Books
- Auto Accessories
- Home And Office Communication Systems

And Much, Much More . . .

With The
FREE
Lafayette
Catalog

You'll also find extraordinary values on other stereo components, radios, ham gear, scanners, cameras, watches, test equipment, calculators, hobby kits, electronic parts and accessories and much, much more. The new 1977 catalog has 164 pages filled with thousands of the newest products and better electronic values for your home, car and office. Behind every product is 56 years of experience, reliability and our money back guarantee. Enjoy shop-at-home convenience and a variety of easy payment plans. Smart buyers know that shopping around is the best way to get the best deal. Shop around in our new catalog and you'll see why so many people think so much of it. Before you buy anywhere else, check the Lafayette catalog. You'll get more for your money.

Send for your free copy today.

Lafayette Radio Electronics Corp.
Dept. 17
111 Jericho Turnpike, Syosset, New York 11791

Send my FREE catalog to:

Name _____

Street _____

City _____

State _____ Zip _____

Lafayette
Radio Electronics & Shopping Centers



FIG. 1—HICKOK model 350.

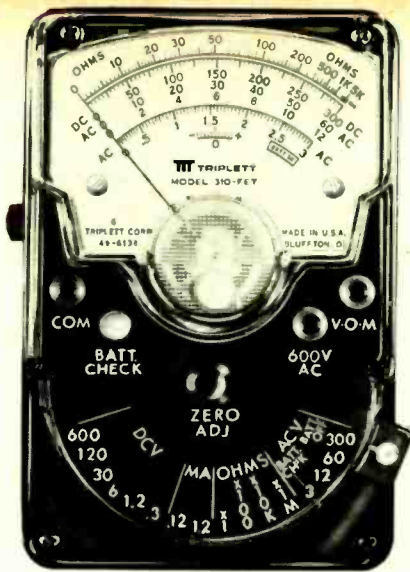

FIG. 2—TRIPLETT model 310-FET.



FIG. 3—B&K model 177 VTVM.

Industrial

A roundup of FETVOM's, amplified VOM's and FETMM's that are

JACK DARR
SERVICE EDITOR

IN THE NOVEMBER 1975 ISSUE OF R-E we covered quite a few of the tests you'll need to make in industrial electronics and electrical work, and the instruments used in doing the testing. Because of space limitations, we were able to cover only the VOM's. Now, as advertised, let's take a look at the "Amplified VOM's"—FETVOM's and FETMM's.

These cover the same basic ranges and functions as the VOM's, and are used for the same kind of testing. Almost all use FET transistor amplifiers; this gives the instruments a very high sensitivity. Typical input impedance runs 10-15 megohms, so they can be used in high-impedance circuits with practically no loading effect. Several of them use IC's, op-amps, etc. which gives them versatility. They can make some measurements that the VOM won't.

The circuits are very low-drain. The instruments are mainly powered by built-in batteries; dry cells or rechargeable NiCad types. Many have built-in recharging circuits. This gives them portability; while they're in use on the bench, the batteries are kept up so that they can be taken to field jobs. The current drain is so small that one

maker says his instrument can be left on at all times, and still get the normal shelf-life from the batteries!

The types designed for industrial work are ruggedized. Cases are made of high-impact plastic, controls are recessed, and test leads are very well insulated. They come in all sizes, like the VOM's. Some can be slipped into your shirt pocket; others are the "standard" size, and some have large meters for bench work with better readability. Accuracy of these types is very good.

Electrically, all of these are well-protected against accidental overload. Fuses and "instantaneous" circuit-breakers prevent damage to the instrument; all have the protective meter-diodes to save the movement.

Digital readouts are beginning to show up here, too. The "DMM's" have the same basic ranges and functions, and the same protection against overload. Their accuracy is very good, giving good results in solid-state circuits where we need readings of very low voltages. They are also handy for working in dark places, with the lighted readout!

You'll see all of these as we go along. Once again, we'll start with the "little fellers," in physical size though not in performance:

The Hickok *model 350* is a handy midget. It has a tough plastic case with

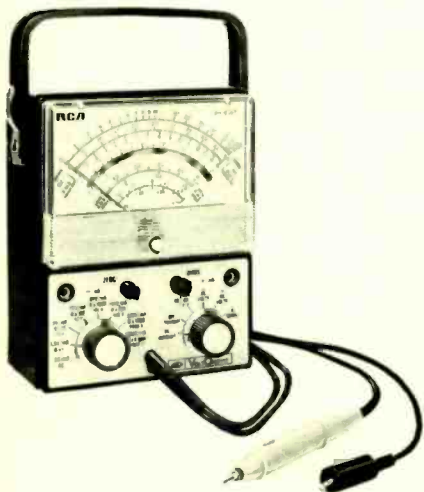

FIG. 7—RCA WV-500B VoltOhmyst. The RCA line of test instruments has been sold to VIZ and are now being manufactured under the VIZ name.



FIG. 4—B&K model 277.



FIG. 5—B&K model 290.



FIG. 6—HICKOK model 370.

Voltmeters

used in industrial electronics and electrical servicing

a protective cover. A full set of AC, DC voltage and resistance ranges are provided, Polarity indication is automatic. The ohms ranges have high-low voltage, for in-circuit transistor tests. It uses an op-amp, with FET input. The meter sees only the op-amp output, for protection. See Fig. 1.

The other "teeny-weeny" may look familiar. It ought to. The Triplett *model 310* has been around for a long time. This is a new one. Even though it looks as if there's no room, they have added a FET amplifier circuit inside the case! So, this one now becomes a "310-FET." Same ranges as the original, with a battery-check light. A handy polarity-reversal switch is on the left side of the case, right where you normally hold it. A flip of the thumb changes the polarity, for fast transistor-testing, etc. See Fig. 2.

In the medium-size and bench models, here's the B&K *model 177* VTVM: See Fig. 3. An AC-powered unit with a large meter, for bench testing and regular maintenance work. Its counterpart in a solid-state version is the *model 277* seen in Fig. 4. Ranges are provided for all standard tests, including AC current. A ruggedized case makes it useful for field work. The *model 290* is a larger-scale model with a meter suitable for bench tests. Both of these have mirror-scale meters for

greater accuracy. See Fig. 5.

Hickok's larger unit is the *model 370* in Fig. 6. This is a FET Multi-meter, with auto-polarity indication on the panel. All controls are push-button, for range and function selection. This one will read AC and DC voltages AC and DC current, and has the high-low ohms feature. It will also read capacitance from .005 up to 10,000 μ F at 60 Hz. A set of decibel calibrations are included; handy for audio work since it will read AC voltage accurately up to 20 kHz.

VIZ has two entries in this field. Both of them are VoltOhmysts. The *model WV-500B* is a standard size case, a FETVOM with the regular ranges. For solid-state work, the lowest DC voltage range is only 0.5 volt full-scale. Top is 1,500 volts. The AC voltage ranges can read RMS or P-P voltages. See Fig. 7.

Another "familiar face" is the *model WV-510A*, a Master Volt-Ohmyst in a solid-state version. It has the large mirror-scale meter and can be used for bench work or field testing. The same basic ranges as in previous VoltOhmyst models are used. See Fig. 8.

Sencore's entry here is a proven model. The *FE-23* "Little Henry" Multimeter is built into a ruggedized plastic case with a carrying handle. All controls are pushbutton, well-

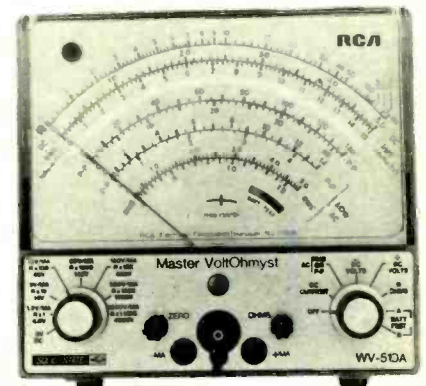

FIG. 8—RCA model WV-510A. The RCA line of test instruments has been sold to VIZ and are now being manufactured under the VIZ name.



FIG. 9—SENCORE FE-23, Little Henry.

spaced for easy use. Li'l Henry has wide range, making it useful for all kinds of industrial-electronics work. The DC voltage ranges go up to 6,000 volts. The AC voltage ranges go to 1,000 volts. There are several "handies" in this instrument. The test leads and jacks are inside a compartment just below the switches. This is not only a handy storage space, but it is used for other things; when you close the lid, a switch automatically turns the power off! For icing on the cake, a special battery is used to provide light for the meter scale. This can be turned on or off by a switch inside the test-lead compartment. A BATTERY-TEST switch is also in there. See Fig. 9.

"Big Henry" has a very similar set of ranges to little brother, and all the same features. This is the model FE27 of Fig. 10. He has a lower range, only 0.3 volt full-scale for both AC and DC, for solid-state work. On the AC



FIG. 10—SENCORE FE-27, Big Henry.

voltage ranges, a special circuit is used to enable reading the "square-wave" AC voltages of TV voltage-regulating power transformers. It gives you the true RMS voltage of such waveforms.

Triplett has a FETVOM, their model 603, called the "Micro-Power VOM." This instrument has a resting current drain of only 10 microamperes; they claim that it will give almost shelf life even if left on all the time. The 603 has AC and DC voltage ranges of 0.3 volt to 1,000 volts, and low-power ohms ranges for transistor work. It will read AC or DC currents from 1.0 mA up to 1,000 mA full-scale. All controls are pushbutton except the range switch; you can get automatic polarity by pushing both + and - buttons at the same time. The meter reads up-scale on either polarity of DC. The + and - buttons can also be used to reverse the polarity of the ohmmeter for quick transistor checks in-circuit. See Fig. 11.

The digital meters

The FET voltmeters, like many other things, are going digital. A couple of representative instruments are shown; one is the B&K 282 DMM in Fig. 12. A 3½-digit display gives bright readings. Ranges and functions are standard. High input impedance is standard. Very high accuracy is possible, to 0.5% on the DC voltage ranges. A smaller version (not shown) is the model 280, which has practically the same features, but in the "standard size VOM" case.

Sencore's new DVM-32 is a ruggedized instrument; very compact, in a tough plastic case. A 3½-digit LED display reads AC and DC voltages up to 1,000. Accuracy of 0.5% on DC gives reliable readings of low DC voltages. High and low ohms scales, and both AC and DC current ranges from 2.0 mA up to 2.0 A make it handy to



FIG. 12—B&K model 282 DMM.

use for any kind of work. The DVM-32 is powered by self-contained batteries, or by rechargeable batteries with an AC charger. A novel feature for battery operation is the "Auto" Display. With the switch in this position, the instrument is "on and ready" but the display is not lit up. When you get any reading above an indicated "10" on the



FIG. 13—SENCORE model DVM-32.

scale, the display lights up. This saves 85 percent of the battery drain. The DVM-32 is protected against overload by fuses and diode clamps. This is only the first of a series: Sencore promises several new developments in digitals in the not-too-distant future.

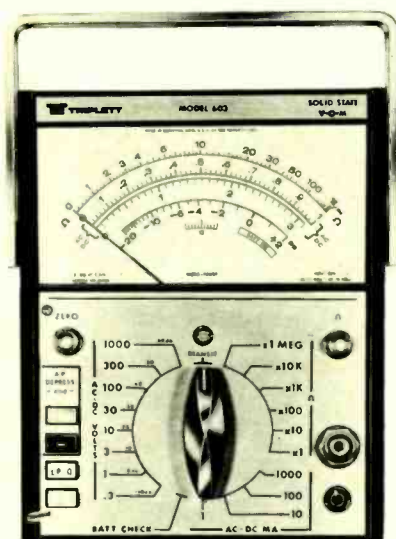

FIG. 11—TRIPLETT model 603.



"I think I can clear up your TV from out here. Do you have a pair of scissors?"

CB testing just became a snap.



MODEL 388
\$349

MODEL 388X
\$475

Hickok Model 388X features a precision temperature compensated crystal oscillator with 1 ppm accuracy.

Now one unit does it all.

Hook our versatile Model 388 in line with your transmitter and instant digital readouts of a transmitter's four most important operating parameters are a turn of a switch away.

A front-panel AM Monitor Output makes scope display of modulation easy. A pushbutton selects front panel or in-line frequency input. And changing to 12V operation is easy, too.

Get your hands on the new Hickok Model 388 CB In-Line Tester. We're betting you can't let go.

The Hickok Model 388 CB In-Line Tester is one element of the modular Hickok CommLine. To put together the CommLine system that's right for you, talk to your Hickok distributor.

HICKOK
CommLine

HICKOK
the value innovator

INSTRUMENTATION & CONTROLS DIVISION
THE HICKOK ELECTRICAL INSTRUMENT CO.
10514 Dupont Avenue • Cleveland, Ohio 44108
(216) 541-8060 • TWX 810-421-8286

Make working on CB's easier with the CommLine from Hickok.

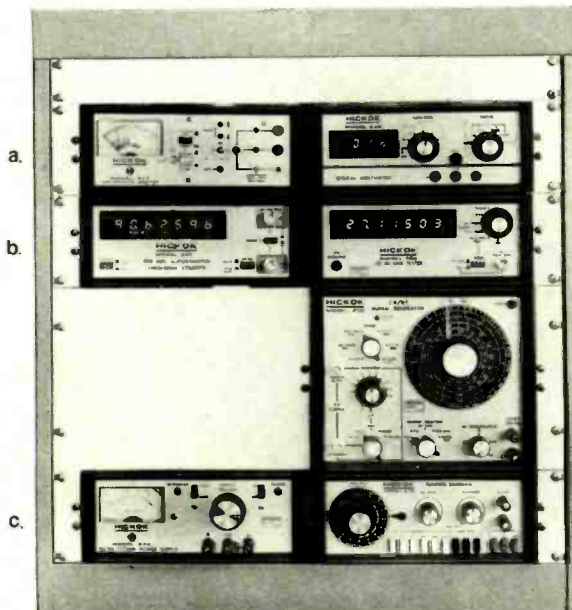

- a) Model 217 Semiconductor Analyzer. \$169
- b) Model 385 Autoranging 500 MHz Frequency Counter. \$499
- c) Model 244 Mobil/Comm Power Supply. \$125
- d) Model 334 Digital Multimeter. \$234
- e) Model 388X Pro CB In-Line Tester. \$475
- f) Model 256 CB / RF Signal Generator. \$199
- g) Model 270 Function Generator. \$189
- h) Model CL-1 CommLine Rack Cabinet. \$35

f. **HICKOK** To put together exactly the CommLine
CommLine CB Service Center you need,
see your Hickok distributor.

g. **HICKOK**
h. the value innovator

INSTRUMENTATION & CONTROLS DIVISION
THE HICKOK ELECTRICAL INSTRUMENT CO.
10514 Dupont Avenue • Cleveland, Ohio 44108
(216) 541-8060 • TWX 810-421-8286

R-E's Service Clinic

The challenge

Troubleshooting with no service data

JACK DARR
SERVICE EDITOR

I FIRMLY BELIEVE THAT MOST OF YOU ARE in this bewildering business for the same reason that I am. You like it! You like to fix things. It's always a challenge to our skill to take something that's dead and make it work again. (You're nuts; you know that, don't you?) We solve puzzles that would drive an ordinary human up the wall, every day. This has to be the reason; we're certainly not in it to get rich!

So, here's a real challenge. Find out just what kind of a hot-shot technician you are. Try this. It must be classified as recreation—play—you are definitely not going to make any money out of it. It will be darn good practice, though. It's fun, and that's the reason I did it. I'll guarantee you that it will sharpen up your diagnostic skills, which is always helpful.

Here's the idea. Find a small transistor radio, of an unknown make. This is the easy part. Get one with a board big enough to see—clock radio, table model, etc. All that is necessary is that it be dead and that you have absolutely *no service data* on it. Sit down, cold-turkey, and *fix it*. To get the most benefit out of this, get a clip-board with plenty of blank paper. Make detailed notes of every test, the reasons for making it, and the results. Take your time and don't leave anything out. That is what I did. I wound up with four and a half pages of notes. Note the start and stop time on each session. I did this. Wound up with four and a half hours of elapsed time. Figure this at your regular rates and you'll see why it isn't a money-maker! After you fix it, you can go back over the notes and recheck your methods. This is valuable data; read it.

OK, here we go. There are test methods we can use for this kind of problem. Open it up and look for the parts that are unmistakable—speaker, volume control, power supply and so on. These are our starting points. Look for any broken wires, burnt resistors or obviously damaged parts. (If you find that the trouble was just a broken wire, that doesn't count! Solder it back and get another set. That's not enough of a workout!)

Troubleshooting

The first step, of course, is to check the DC power supply. You'll usually

find a little power transformer; follow the leads to the rectifier(s) and then find the filter capacitors. You can find the DC output voltage by checking the voltage rating of the filter capacitor. Most of these will be something like 6.9 or 12 volts DC. Verify this by turning it on and reading the AC voltage across the rectifiers.

Now check the DC voltage output. If this is well *below* the AC voltage, the chances are that you have either a short or a heavy leakage. If you find a burnt resistor, lift one end to open the circuit and recheck the DC power supply. You can open the circuit and put a DC milliammeter in series. (Start on a high scale, 1,000 mA at least! Mine was drawing about 250 mA, which is far too much for this type of set. Typical current drain will be about 15 mA with no volume, and about 35-40 mA full volume.)

High current and no sound except for a little hum (which is what I had) usually means trouble in the output stage. You can locate this by following the voice coil leads back from the speaker. If they go to a big electrolytic, you have an OTL output stage. If they go to a transformer, it is a transformer coupled stage. You can check from the transformer and find the output transistors. Check these with an ohmmeter. This will find any with a dead short.

If the problem is high leakage, you'll have to take them out for a definite test. A curve-tracer or one of the new transistor testers that identifies the base pin on any unknown transistor is a big help! Find the base, and then you can find the emitter by checking to see which pin has a small resistor to ground. (In push-pull Class-A transformer stages.)

With the output transistors removed, check the power supply. If the voltage jumps back up and the current drops, scope the base terminal and see if there is audio there. If so, the problem is in the output stage.

One thing you must find is the common or return of the DC power supply. In mine, it was the center-tap lead from the power transformer secondary that was switched. A full-wave rectifier circuit was used. This lead went to a glob of solder on the frame of the output transformer. Here's a pitfall that I fell into. In older sets, the cans of the

REPLY COUPON

Expires 10/30/76

This column is for your service problems—TV, radio, audio or general and industrial electronics. We answer all questions individually by mail, free of charge and the more interesting ones will be printed here.

If you're really stuck, write us. We'll do our best to help you. *This coupon must accompany all questions. No reproductions or facsimile will be accepted.* Don't forget to enclose a stamped, self-addressed envelope. If return postage is not included, we cannot process your question. Write: Service Editor, Radio-Electronics, 200 Park Ave. South, N.Y. 10003.



**The antenna
specialists CB antenna.
We give it our
stamp of approval
before we ask you
to give it yours.**

For the 20th consecutive year, more Antenna Specialists brand antennas are in use than *all other brands combined*. Three reasons: proven, superior engineering and workmanship so *they work better*... clean, simple, professional designs... so *they look better*... highest quality components so *they last longer*.

look for the stripes of quality

**the antenna
specialists co.**



® "Stripes of Quality"

a member of **The Allen Group Inc.**
12435 Euclid Ave., Cleveland, Ohio 44106
Export: 2200 Shames Drive, Westbury, L.I. New York 11590
Canada: A.C. Simmonds & Sons, Ltd.

number one CB antenna by a country mile

Circle 39 on reader service card

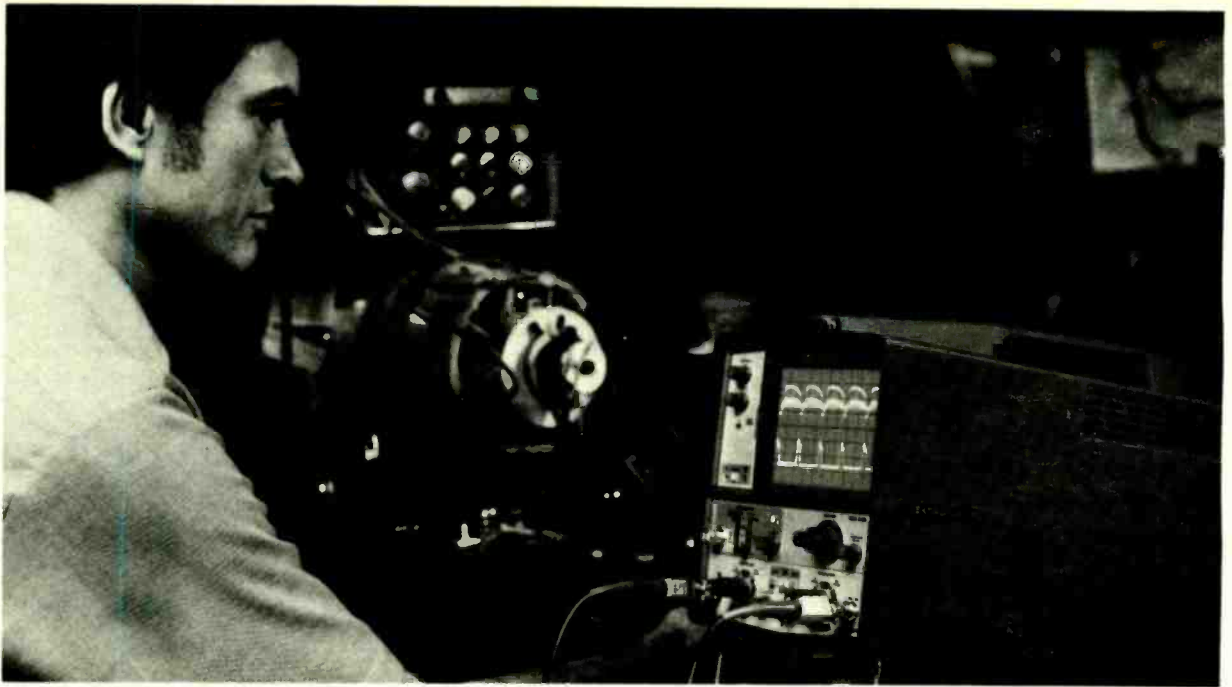

Now you can service with a TEKTRONIX Oscilloscope for as little as \$695*

Cost of service instruments is an important factor in any purchase. But so is reliability. Now T900 Oscilloscopes give you both Tektronix quality *and* reliability at prices *designed* for cost sensitive applications.

- T921—Dc to 15 Mhz; single trace,
single time base \$695*
- T922—Dc to 15 MHz; dual trace,
single time base \$850*
- T932—Dc to 35 MHz; dual trace,
single time base \$1195*
- T935—Dc to 35 MHz; dual trace,
delayed sweep time base \$1395*
- T912—Dc to 10 MHz; bistable stor-
age; writing speed to 250
cm/ms; dual trace, single time
base \$1300*

Performance to Spare

All T900 scopes feature large (8x10 cm), bright crt's; sensitivity of 2 mV/div to 10 V/div in twelve calibrated steps; regulated power supplies; and 3% accuracy. T900 Oscilloscopes are also equipped

with important convenience features; beam finder, single knob triggering, automatic selection of chopped or alternate mode, and automatic selection of tv line or frame display (except T912 Storage model). T900 scopes are compact (7x9x19 in.) and lightweight (only 16 lb.). They are available with a full selection of accessories.

For a demonstration of any T900 Oscilloscope or a free copy of the new T900 brochure, write to Tektronix, Inc., P.O. Box 500, Beaverton, OR 97077. For immediate assistance, call (503) 644-0161, extension T900.

T900 Series the quality low cost Oscilloscopes

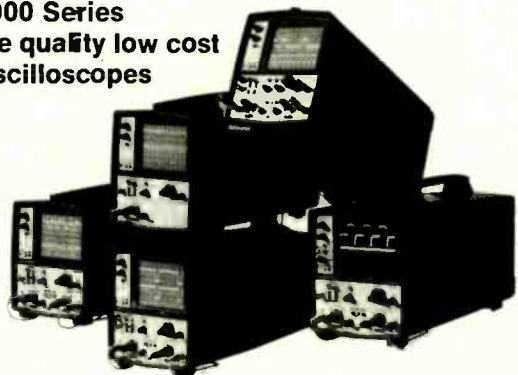

*All prices include 10X probes. Prices FOB Beaverton, Oregon.



TEKTRONIX®

committed to
technical excellence

Circle 101 on reader service card

SERVICE CLINIC

(continued from page 88)

electrolytic capacitors were all common. They're NOT in these little monsters! Also, on the front of the chassis was a metal bracket that wasn't common either, but floating! I finally found a pad of solder along one edge of the board where I could hook the return lead of my voltmeter. In this case, the output transistors were 2SB77's, which are PNP. So, my DC power supply was negative. If the switch lead is like this one, this is a handy place to connect the milliammeter.

From initial tests, I decided that one of the output transistors was bad. So, I pulled it. I looked up a replacement, and tacked it in. Now, I could receive a local station, with very bad distortion. Current drain was still 200 mA. The new transistor got hot enough to burn your finger! I turned it off again to check the transformers, etc. These seemed to be fine. However, I noticed that although the bases of the output transistors were fed from the ends of a center-tapped secondary, they showed different voltages! One was almost double the other. So, what did I do? I checked the preamplifier stage, the driver, and so on. (This is one of the mistakes that you see when you re-read your notes!)

Other things testing good. I went back to that output stage. There was a strange extra transistor close to the outputs. This turned out, after much tracing, to be a DC voltage regulator! It was bad. There was a diode in the base circuit (transistor with collector lead cut off) that was also bad. Replaced these. Still no help. (This took a lot longer to do than it does to write!)

That base voltage unbalance still puzzled me. So, I pulled both transistors and rechecked them (The other original had not been pulled, remember?) My new one was good, but the other one was bad. Terrific leakage. So, back to the transistor guide and hunt up a substitute. Get a pair out of stock (and check them both on the curve-tracer. I was learning. Slowly, but learning.) They match. So, tack them in and turn the set on (which isn't easy to do with your fingers crossed.) Oh, wow. Current drops to about 25 mA. Volume good, tone clear, everything working. NOW the base voltages of the output transistors are the same.

So, there it was. I believe that in most of these sets, the trouble will turn out to be in the DC power supply or output stage or both. If you do have the audio output working and the trouble seems to be in the RF or IF stages, you can pin it down by loosely coupling a signal into the mixer, which will be close to the tuning capacitor.

(turn page)

Why any cartridge (even ours) with an elliptical stylus must be considered just a bit old-fashioned.

Perhaps you've tried to track your records at the lowest advertised setting for your elliptical stylus. In the hopes of optimizing performance and reducing record wear. But every footstep threatens to bounce the stylus out of the groove. And big crescendos are simply *fuzzy*. Should you get a better player? No. Get a better stylus.

We have a sensible new approach. A stylus shape that contacts more of the groove wall, to spread tracking force over a greater vertical area. The Shibata

stylus. It safely tracks your records at up to 2 grams while maintaining response to 45,000 Hz, offering great stereo separation, and *reducing* record wear . . . even compared with an elliptical stylus at less than a gram.

Put an Audio-Technica Dual Magnet UNIVERSAL cartridge with genuine Shibata stylus in your good old record player today. It's a great combination for better sound today and tomorrow, and tomorrow.



audio-technica

INNOVATION / PRECISION / INTEGRITY
AUDIO-TECHNICA U.S., INC., Dept. 96E, 33 Shiawassee Ave., Fairlawn, Ohio 44131
Available in Canada from Superior Electronics, Inc.

Don't broadcast the fact that you've got a CB radio

Now you don't have to let everyone know that you've got a mobile CB radio. Our model MR264 disguise antenna looks and acts just like a normal car radio antenna, operating on AM and FM as well as CB. We know the disguise is effective because we've been making them



for law enforcement agencies for years. If you don't need a disguise antenna, but you do want superior CB performance in a conceal mounted 3-way antenna, check out our model M-267. Both models feature a stainless steel whip that detaches easily so your antenna won't get ripped off in the car wash either. When you're looking for antennas, 3-way, disguise or otherwise, take advantage of our 20 yrs experience. Look for the Stripes of Quality.

**the antenna
specialists co.**



a member of The Allen Group Inc.
12435 Euclid Avenue
Cleveland, Ohio 44106
Export: 2200 Shames Drive
Westbury, N.Y. New York 11560
Canada: A. C. Simmonds & Sons, Ltd.

© 1976 by the Antenna Specialists Co.

Circle 40 on reader service card

You can identify the intermediate frequency used by tuning the signal generator back and forth. Most of these have sealed IF transformers, which is good! Also, the alignment adjustments on the tuning capacitor are so small that most people don't even know they're there.

You'll note that there are no illustrations in this article! You're supposed to have the circuits in your head! However, if you want to be sneaky (which I was!), you can take a peek at a few typical transistor circuits in Sams TSM manuals, and get a good refresher course in what you're apt to find.

As I said in the beginning, you didn't

make any money. It was very good practice though, wasn't it? Builds up your self-confidence. It takes two things to solve a problem like this. One is a very good knowledge of electronic circuits and tests, and the other is good clear rational THINKING. R-E

reader questions

ALPHANUMERIC DISPLAY UNIT
I'm looking for a device that displays letters instead of numbers. I've searched

in vain. What would this look like and who makes them?—L.E., Suffield, CT.

It would look something like the diagram. This one is a liquid-crystal device

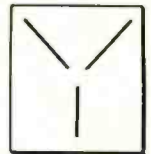
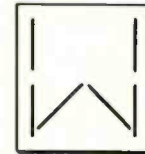
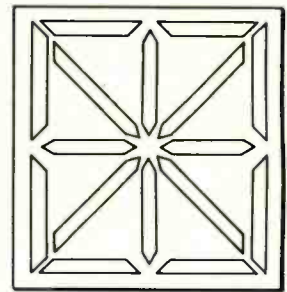

made by Hamlin Electronics, Lake & Grove Streets, Lake Mills, WI 53551. Litronix, 19000 Homestead Road, Vallco Park, Cupertino, CA 95014, makes a similar device with "dot" LED's.

SYNC TRANSFORMER

I can't find a replacement for the synchronizing transformer on an RCA 155B oscilloscope. Can I modify the circuit to work without it?—K.H., Pacific, MO.

I don't think you'll have to. This seems to be just a plain audio transformer with a 1:1 ratio. It would be an

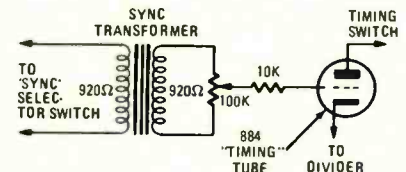

interstage type. Try a Triad T-33X using only one half of each winding. This ought to be very close to the original. If you can locate any other type with about the same resistance, it ought to do.

WHAT'S THE 'K' FOR?

Would you please explain the following resistor nomenclature? The nomenclature in question is: 2K2, 2K7, 6K8, etc. I'm really at a loss and so are all of the people I've asked so far!—C.S., Springfield, VA.

This I can do. I ran across this in *Wireless World* (published in London) some time ago. The British use this and I think several other European countries do as well. It's a very good system, and I like it!

The K stands for kilohms and is used in place of the decimal point. So, a 2.2K resistor would be written as 2K2, 4.7K as 4K7, etc. Even valves, such as 25K, are written as 25K. For larger resistors, a 3M9 is a 3.9 megohm resistor. This does away with the possibility of confu-

EDLIE'S BARGAIN BONANZA ONLY HIGHEST QUALITY PRODUCTS

- SPECIAL BUY**
AMPEX 60 min. cassette tapes only .99¢ each 3 for \$2.69 12 for only \$8.99
- Single conductor SHIELDED WIRE #22 Gauge good for Microphone or stereo cable. Gray color only 25 Ft for \$1.00 100 foot for only \$3.39
Same wire as above with 2 conductors and two shields 25 ft for \$1.25 100 foot for only \$4.39
- (R017) COPPER CLAD BOARDS! Copper on one side, 1/16" thick. Excellent quality for either production or experimental work.
Just arrived doubled sized copper, 1/16" thk. Size 12"x18" \$1.99 ea., 3/\$4.99.
E) 6"x17 1/2" \$1.19 ea. 3/\$2.99
- (R134) 8 ROTARY SWITCHES Some multiple gang. \$1.00
- (R128) 13 MINIATURE ELECTROLYTIC CAPACITORS \$1.00 Axial & upright, popular values.
- (R144) TRANSISTOR REPAIR KIT \$1.19 Various parts used to repair transistorized devices.
- (R336) TO-3 TRANSISTOR SOCKETS 12 for \$1.00
- (R164) 4 ROLLS OF WIRE \$1.00 Approx. 25 ft. per roll, 20-28ga.
- (R140) TAPE RECORDER SPARE PARTS KIT \$2.95 Parts for repairing most tape recorders: capacitors, meter, pilot lamp, jacks, and MUCH MORE.
- (R167) 10 MINIATURE POTENTIOMETERS \$1.00
- (R182) 2 MISC METERS \$1.00 Miniature.
- (R156) 60 DISC CAPACITORS \$1.00 Asst. from .0001 to .1, most 600v, Z5U, NPO, N750, etc.

SURPLUS TUBES
All guaranteed for 1 full year.
ANY 3 FOR \$1.49
Acquired from U.S. Defense depots or removed from equipment (new and used). These are laboratory tested and guaranteed for one full year. Most are of such standard makers as RCA, GE, etc.

3A3	6AQ7	6DE4	12AE7
3AF4	6AT6	6DR7	12AL5
3BN6	6AU6	6DW4	12AU7
3DG4	6AV6	6EB8	12AV6
3KT6	6AX4	6EM7	12BE6
3Q4	6AX5	6GF7	12BH7
4BC5	6AV3	6GH8	18FW6
4BN6	6BA6	6K6	25L6
4BU8	6BG6	6K11	35EH5
4BZ7	6BJ8	6L86	36AM3
5V6	6BQ6	6SN7	50A5
6AF4	6BZ6	6T8	50L6
6AG5	6CB6	6W4	
6AG7	6CG7	6X4	
6AL5	6CM7	10EW7	

- (R147) 4 lb. GRAB BAG SPECIAL \$1.00 Full of exotic and exciting electronics parts.
- (R155) TUBE BONANZA! \$1.00 20 asst. popular tubes, untested.
- (R142) 50 PRECISION RESISTORS \$1.00 All 1%, 1/2w and 1w, low and high ohms.
- (R150) POWER TRANSFORMER Primary 117 volts. Sec. 1-11.1 volts; Sec. 2 17.7 volts; Sec. 3 15.9 volts; Sec. 4 27.7 volts. 3 Each winding approx. 750 mils. Size 2 1/4"H x 2" D x 3 1/8" mounting centers. (Fig. 3). Price \$2.45
- (R175) 70 1/2w CARBON RESISTORS \$1.00 Asst. values. Some 5%.
- (R154) 150 CUT LEAD RESISTORS \$1.00 Carbon, all leads long enough for soldering.
- (R149) 20 POLYSTYRENE TOP GRADE CAPACITORS \$1.00
- (R132) 20 DUAL POTS \$1.00

MONEY BACK GUARANTEE
Terms: Minimum order \$4.00. Include postage. Either full payment with order or 20% deposit, balance C.O.D.

WRITE FOR FREE 1976 VALUE PACKED CATALOG
Listing thousands of components, tubes, transistors, IC's, kits, test equipment.

BONUS FREE CAPACITOR KIT With Every \$5 Purchase

THIS MONTH'S SPECIALS!

- 74\$15 Schottky 3 inp pos AND. O.C. 45¢
- 739 Dual lo-noise pre-amp 85¢
- P8815A Dual 4 inp. NOR 2 for \$1.00

TTL

- | | | | |
|-------------------------------|--------|--------------------------------|-----|
| <input type="checkbox"/> 7400 | 16¢ | <input type="checkbox"/> 7446 | 80¢ |
| <input type="checkbox"/> 7401 | 18¢ | <input type="checkbox"/> 7447 | 80¢ |
| <input type="checkbox"/> 7402 | 23¢ | <input type="checkbox"/> 7448 | 80¢ |
| <input type="checkbox"/> 7403 | 23¢ | <input type="checkbox"/> 7473 | 49¢ |
| <input type="checkbox"/> 7404 | 23¢ | <input type="checkbox"/> 7474 | 49¢ |
| <input type="checkbox"/> 7405 | 23¢ | <input type="checkbox"/> 7475 | 85¢ |
| <input type="checkbox"/> 7406 | 23¢ | <input type="checkbox"/> 7476 | 53¢ |
| <input type="checkbox"/> 7410 | 23¢ | <input type="checkbox"/> 7490 | 79¢ |
| <input type="checkbox"/> 7411 | 27¢ | <input type="checkbox"/> 7492 | 79¢ |
| <input type="checkbox"/> 7413 | 40¢ | <input type="checkbox"/> 7493 | 69¢ |
| <input type="checkbox"/> 7420 | 23¢ | <input type="checkbox"/> 7495 | 79¢ |
| <input type="checkbox"/> 7430 | 23¢ | <input type="checkbox"/> 74121 | 57¢ |
| <input type="checkbox"/> 7440 | 30¢ | <input type="checkbox"/> 74122 | 57¢ |
| <input type="checkbox"/> 7442 | \$1.12 | <input type="checkbox"/> 74123 | 67¢ |

LINEARS

- LM309K 5v la reg. \$1.15
- 555 Timer 75¢
- 556 Dual 555 \$1.00
- 566 Function gen. \$1.75
- 567 Tone decoder \$1.95
- 741 comp. op amp 39¢
- 2102 1024 bit RAM \$4.95
- 2513 Char. Gen. \$5.95
- 8038 volt cont osc \$4.25

CLOCK CHIPS WITH DATA

- (MM5314) 6 dig clock \$4.95
- CT 7001 Alarm & Date \$5.95

LED'S

- (R223) 10 Asst LEDs \$1.00
- (R242) 5 Jumbo Green LEDs \$1.00
- (R242) 5 Med Yellow LEDs \$1.00
- (R001) 5 Jumbo Red LEDs \$1.00
- (R011) 5 Med Red LEDs \$1.00
- (R012) 5 Mini Red LEDs \$1.00
- (R293) DL707 (equiv.) 7 seg red LED, .3" char, comm anode \$1.00
- (R007) DL747 7 seg red LED, .6" char, comm anode \$1.95
- (R013) MAN 5 (equiv.) 7 seg green LED, .27 char, comm anode \$1.49
- (R006) D.L. 704 (equiv.) same as D.L. 707 except comm-cath \$1.35

IC BREADBOARDS & TERMINALS

- Boards have .042 holes. Made of 1/16" polyester glass.
- (RB663) 3"x4" 94¢
 - (RB664) 3"x6" \$1.29
 - (RB665) 4"x6" \$1.65
 - (RB666) 4"x8" \$2.12
- Push-in terminals
- (RP6601-20) pkg 20/90¢
 - (RP6601-100) pkg 100/\$2.89
- Push-in flanged pins
- (RB6602-20) pkg 20/90¢
 - (RB6602-100) pkg 100/\$2.98
- Push-in flea clips
- (RB6603-20) pkg 20/90¢
 - (RB6603-100) pkg 100/\$2.89
 - (R008) 14 pin DIP sockets 3 for \$1.00
- (R1104) IC REMOVAL AND INSERTION TOOL \$4.95 "Pul-n-sertic" extracts and inserts ICs without damage.

EDLIE ELECTRONICS, INC., 2700-R HEMPSTEAD TPKE., LEVITOWN, N.Y. 11756

Circle 33 on reader service card

sion due to a missing decimal point, or a lightly printed one.

SOUND, NO VIDEO

I have sound but no video in this RCA CTC-30. This began as an intermittent, and finally the picture went out and stayed out. Tubes are all good, voltages OK. Can you suggest something?—L.H., Milford, MI.

Yep. If you have sound but no video, the signal must be getting as far as the video detector. Woops; plate of 3rd IF tube is sound takeoff in this one! So, this leaves us with a couple of things.

One is the video detector diode, which is unlikely—seldom intermittent. The other is some problem in the 1st/2nd video amplifier tube, the 6LF8. Now *this* can be intermittent. For one thing, check to be sure that this tube is *lit!* (Feedback: Reader says "That was it. Bad connection to heater of 6LF8! How did you do it?") (Easy; I've been finding the same thing in my own set off and on for quite a while! Hi!)

NO CONTROL OF BRIGHTNESS

I can't control the brightness on this Zenith 12A12C52. All of my DC voltage supplies are OK. The voltages on the 3rd video amplifier transistor are all low. On the 2nd video amplifier transistor, I get +2.6 volts on the emitter, +3.1 volts on the base, and +2.6 volts on the collector. The set was hit by lightning.—R.K., Davenport, IA.

Look again at those DC voltages on the 2nd video transistor! Note that the emitter and collector are exactly *the same*. Normal voltages are +13.6 volts on collector and +5.14 volts on emitter. This is pointing to the very good chance of a collector-to-emitter short. The collector voltage of the 2nd stage is directly coupled to the base of the 3rd video stage. So, this would upset that stage as well. Check this transistor with the ohmmeter. When lightning has been around, you're apt to find such things anywhere in the set.

POWER SUPPLY TOO LOW

I've got an old 6-12-volt bench power supply. Works very well on most things. I have problems on cassette recorders, etc., in getting the thing to eject. Apparently I don't have enough current to make it work right. Do you have any ideas as to how I could raise the current rating?—A.R., Unity, SK.

There are a couple of things you might try. One is a bit wild and I have not tried it, but it might do. Add a big filter capacitor right across the DC output; you can get monstrous big ones from some of the ads in the back pages of R-E. All you really need is a short pulse of high current to make the eject solenoid work, and the charge in the capacitor could provide that. Big capacitor acts as a reservoir. (turn page)

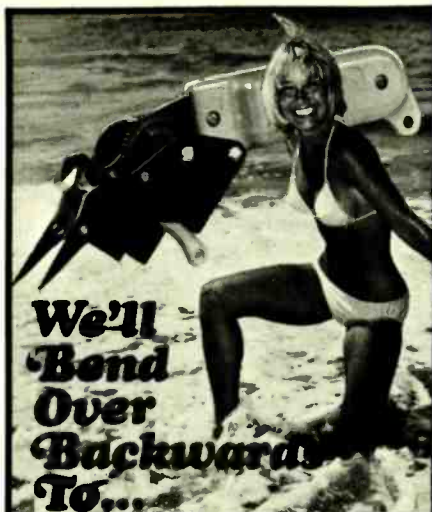

We'll Bond Over Backwards To...

SPEED UP PRODUCTION OF YOUR COMPONENT LEAD BENDING OPERATIONS.



1. MEASURES EXACT BEND SPACING
 2. STRAIN RELIEF CLAMPING
 3. MAKES PRECISION BENDS FOR EASY INSTALLATION
- CALL OR WRITE TODAY FOR FREE, COMPLETE INFORMATION.



HARWIL COMPANY
1548 17th St.
Santa Monica, Ca. 90404
(213) 829-2310

Circle 12 on reader service card



You can build a better organ than you can buy!

A magnificent Schober Electronic Organ

What a marvelous way to put your special talents to work! With our Schober Electronic Organ Kits and your skill, you can build yourself some very special satisfaction, and a lifetime of great music!

Schober Organs are literally far superior to comparably-priced "ready-made" units. You could actually pay twice as much and get no better organ... and miss the fun of assembling it yourself. A PC board at a time, component by component, you'll assemble your own "king of instruments." And when you're done, you'll wish there was more to do. And there is! For then, Schober will help you learn to play, even if you've never played a note before!

Schober Organ Kits range from \$650 to \$2850, and you can purchase in sections to spread costs out... or have two-year time payments.

Just send the coupon for the fascinating Schober color catalog (or enclose \$1 for a record that lets you hear as well as see Schober quality.)

The Schober Organ Corp., Dept. RE-154
43 West 61st Street, New York, N.Y. 10023

- Please send me Schober Organ Catalog;
 Enclosed please find \$1.00 for 12-inch L.P. record of Schober Organ music.

NAME _____

ADDRESS _____

CITY _____

STATE _____

ZIP _____

Circle 81 on reader service card

One of the best CB Antenna ideas we've hatched in 20 years.

Hatchback and fastback car owners of the world, rejoice. Now you too can enjoy excellent CB reception. Our model M-431 CB antenna doubles as a hatchback mount and a trunk groove mount. Its unique mounting hardware lets you adjust the antenna to a perfect vertical position to compensate for roof line slant. The stainless steel whip and shock spring combine with a weather-proof, base loaded coil for maximum durability and performance. When you're looking for antennas, take advantage of our 20 years experience. Look for the Stripes of Quality.



the antenna specialists co.

a member of The Allen Group, Inc.
12435 Euclid Avenue
Cleveland, Ohio 44106
Export: 2200 Shames Drive
Westbury, L.I. New York 11590
Canada: A. C. Simmonds & Sons, Ltd.

© 1976 by the Antenna Specialists Co

Circle 41 on reader service card



also available in a center loaded model M-432.

Got a scanning monitor? Model MON-60 is a hatchback monitor antenna.

Distinctly Superior Performance

LEARN AVIATION ELECTRONICS



at the School
of Aeronautics,
Florida Institute
of Technology.

Prepare for a REAL job in just
2 years and earn a COLLEGE
DEGREE at the same time.

FAA publications identify that
by 1977 the AVIATION IN-
DUSTRY will need 230% MORE
AVIONICS TECHNICIANS.

Half the costs of airplanes to-
day is in electronics, including
navigation systems . . . in-
struments . . . communica-
tions systems . . . and con-
trol systems.

We teach you in our labora-
tories . . . classrooms . . .
and on our aircraft the theory
of radio communications and
how to flight check and repair
all related equipment.

Our placement record of grad-
uates is 100%. . . . Make
your time and money spent
REWARDED by a job in your
field.

The SCHOOL OF AERONAU-
TICS operates one of the larg-
est flight training programs in
the WORLD and we are an
"accredited University".

Classes starting September
. . . January . . . June.

To learn more about our avia-
tion electronic programs,
check the reader service card
or write direct to:

The School of Aeronautics,
Florida Institute of Tech-
nology, P.O. Drawer 1839,
Melbourne, Florida 32901
Att: Director of Admissions

Second thing would be to check your rectifiers. If these are selenium, they may have dropped off in output. You can also get high-current low-voltage rectifiers from those same ads. They're making silicon types now with plenty of current rating. All you'd need would be something like a 50-volt rating for this.

FUNNY SHAPED RASTER

The raster on this 20Y1C48 Zenith has an odd shape. With a crosshatch pattern, the vertical lines on each side pull in at the bottom. I've checked a lot of things with no luck.—G.S., Warren, MI.

There is one "funny" that can cause a "fake keystone" raster in some Zeniths. This is the 30- μ F electrolytic capacitor on the screen of the vertical output transformer (the red wire). This is a "waveshaping" capacitor that actually works in the pincushion corrector circuitry. It is not the screen bypass that is directly on the screen terminal with a resistor between it and this one. Try a new capacitor here and see.

CB PROBLEM

I liked your article on CB testing. Now I have a problem! This CB transmitter will tune up fine on a dummy load with an in-line wattmeter. Modulation causes reading to go up, as you said. But! When I hook up the vehicle antenna and modulate it, the reading goes down. Using a field-strength meter at the same time, its reading goes down too. There is an antenna-matcher unit in the line. I don't get it.—C.E., Great Neck, NY.

When you can tune up a transmitter on a properly matched dummy load and get normal output and modulation, that transmitter is working. The only thing you're changing when you go to the vehicle is the antenna! I've tuned up many a two-way radio on a dummy load, then moved it into the vehicle and never had to move a tuning adjustment. So; go thou and see what is the matter with the vehicle antenna! For a crystal ball hint, the transmission line may not be grounded at the antenna base, or something. That was one of my favorite goofs!

FIX FOR HOT TRANSISTORS

Your "Quick and Dirty" fix for over-heating transformer, output transistors and so on, works! You said to add a small resistor in series with the collector supply of each transistor to act as a current limiter. I did. Worked like a charm! Currents much lower, output still OK, and customer happy. Thanks!—C.K., Ft. Gibson, MS.

Glad to hear it! I was a little ashamed to use this, but not long ago I saw a modification hint from one of the better-known hi-fi amplifier makers. and that's what they were doing. So, I feel better.

WHAT SIZE RESISTOR?

I have an old DuMont amplifier. The tubes used are 6C4, 12AX7 and two 50C5S. The cathode resistor from pin 8 of the 12AX7 is burnt up and I can't find a schematic. Can you help?—W.W., Calumet City, IL.

Can't identify this chassis, but I can give you a crystal-ball guess on the resistor. The 12AX7 will be one of two things, or both. Probably used as audio driver and a phase-inverter to drive the 50C5's. If it's the audio driver [check for coupling capacitor from pin-6 (plate) to pin-2 (grid)], the cathode resistor will be about 330-ohms bypassed by something like a 0.1 μ F capacitor.

If the triode (pins 6, 7 and 8 of the 12AX7) is the phase inverter, it'll probably be a "split-load" type. In this circuit, the resistors in the plate and cathode will be the same size (about 270K), and there will be a coupling capacitor from both the plate (pin 6) and cathode (pin 8) to the grids of the 50C5's.

NO COLOR

The black-and-white picture is good in this Motorola TS-929 chassis, but I have no color at all. If I put a small positive bias on the base of the ACC amplifier, I can get rainbows. I've changed the pulse amplifier, burst gate and burst amplifier transistors, and the crystal. No luck.

The burst amplifier doesn't seem to be working. I get a 1.0 V P-P pulse on the

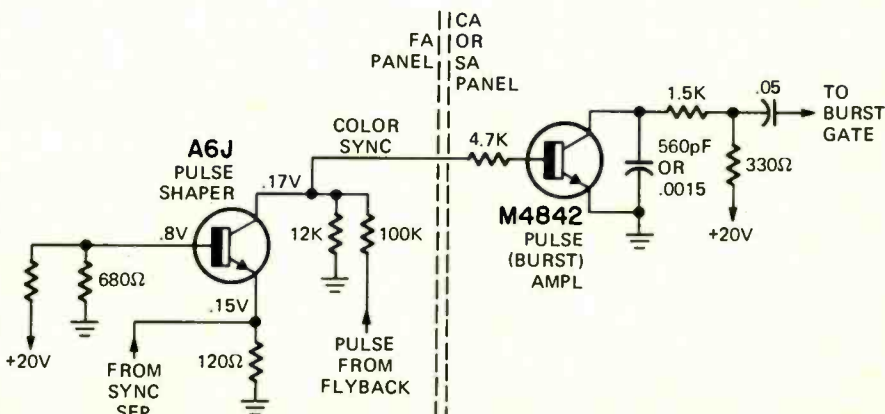

base and only 4 V P-P on the collector. This should be 30 volts P-P. Any ideas as to where to look now?—W.K., E. Sparta, OH.

I believe I'd go "downhill", on the schematic, that is. Your burst-amplifier stage seems to have normal voltage gain. Note that you read 1 volt in and 4 volts out. The schematic shows 8 volts in and 30 volts out, (P-P) which is a gain of four. Your input pulse is only 25% of normal.

This comes from the pulse shaping stage (which the Motorola diagram calls Pulse Former). In the Sams schematic, 1207-2, this is Q1 on the FA panel. There is nothing between this stage's collector and the burst amplifier's base except a 4700-ohm resistor.

It is often possible for a transistor to open a junction, yet you will see a certain amount of signal getting through. This is due to the very close spacing of the elements. Combined vertical and horizontal sync pulses are fed to the emitter of this stage. Check it for amplification.

THE FLUTTERING PICTURE

The picture on this Sylvania B10 fluttered. I never saw so many things at once. It was: 1. shrinking about an inch top and bottom; 2. pulling in at both sides, about the same amount; 3. bending slightly on the edges; 4. brightness went up and down; 5. rolling about every 3-4 seconds. All of this happened at the same time, at a rate of about 1 or 2 per second.

This was due to an open output filter capacitor, C500B, 100 μ F. The ripple on this line read about 125 volts P-P.

Thanks to: Leon Caldwell, Caldwell's TV, Mena, AR.

REPEAT PROBLEMS

I wrote you about a jail-bar symptom in a Sears 562-10421 quite a while ago. You recommended checking the 50- μ F AGC bypass capacitor. I'd replaced this last November! When I went back to this set, I rechecked that. Sure enough; the one I had put in was defective! This is the third time in as many months that we've had problems with defective or mis-marked new parts!—E.B., Largo, FL.

I know what you mean. I've been there!

RECTIFIER CAP ARCING

I've got a problem with arcing from the high-voltage rectifier plate cap in a Nivico 7208. I can't find a replacement for the flyback in any of the Guides.—M.B., LaCrosse, WI.

I can't find a substitute for the flyback either! However, you might try using one of the very well insulated plate cap units. For instance, Oneida Electronics A-177, which has a long skirt and high-voltage wire.



**save on gas!
save on tune-ups!
save on maintenance!**

Electronic ignition is "IN"! So says Detroit.

Update your car with either a TIGER CD or a TIGER I breakerless system.

Enjoy the benefits of better gas mileage, quicker starting, elimination of tune-ups, 50,000 miles on points and plugs, and reduced maintenance expenses.

TIGER MAX CD	\$69.95
TIGER 500 CD	59.95
TIGER SST CD	42.95
SIMPLIST CD	31.95
TIGER I	45.95

Postpaid U.S.A. only.

Tri-Star Corporation

Dept. WW, P.O. Box 1727
Grand Junction, Colorado 81501
Circle 23 on reader service card

**STEREO
CHORD EGG**



THE ULTIMATE
MEDITATION
ENVIRONMENT
MACHINE

The EGG plugs into any stereo amp to create soothing, flowing environmental sound textures - and through headphones it's incredible. The chords and notes EXIST in your mind, they pan and swell and phase their way through your psyche in unpredictable patterns never repeating.

The combination of LSI organ technology with synthesizer-type processing and digital randomizing/control elements make the EGG an altogether intriguing package from either technological or metaphysical viewpoints.

Kit includes: Circuit board, parts and step-by-step instructions.
CHORD EGG Kit \$24.95 postpaid
*Encephalo Gratification Generator

— FREE CATALOG —
IAA ELECTRONICS DEPT. 9-R
1020 W. WILSHIRE BLVD.
OKLAHOMA CITY, OK 73116

Circle 26 on reader service card

Instant CB Antennas. Now you see 'em, now you don't.

The beauty of Antenna Specialists temporary CB antennas is that they can be mounted and unmounted in seconds without leaving a trace. That can be important for security, or if you rent or change cars frequently.

Our model MS178 magnetic mount has powerful ceramic magnets that grip firmly even at highway speeds. A detachable, in-line mini-connector permits antenna removal without disturbing the cable. Instant mounting is also available in an economy magnetic mount, the M-440 and our MR131 gutter mount.

Take advantage of our 20 years experience. Look for the Stripes of Quality.

the antenna
specialists co.



© Stripes of Quality.
a member of The Allen Group Inc.
12435 Euclid Avenue
Cleveland, Ohio 44106
Export: 2200 Shames Drive
Westbury, L.I. New York 11590
Canada: A. C. Simmonds & Sons, Ltd.

Distinctly
Superior
Performance

© 1976 by the Antenna Specialists Co.

Circle 42 on reader service card



SEPTEMBER 1976

avanti ASTROPLANE CB base antennas give you patented performance



The unique construction features are so exceptional they are covered by U.S. Patent #3587109. 4.46 db gain over isotropic provides a stronger signal in and out.

To make use of the better signal, the Astroplane radiates the signal from higher up than other CB antennas and at a better angle. According to Dr. Alva Todd of the Midwest College of Engineering, "it possesses an unusually low angle of maximum radiation." This low angle of radiation means that your power is radiated at the horizon and not up into the clouds for greater efficiency.

You'll also get long lasting, trouble-free performance because it is compact in design—without long drooping radials, without coils to burn or short out, and high power capacity for lightning and static dissipation.

\$36.95 Suggested Retail
Length 12 Ft. • Dia. 30 in.

Free 24 page color catalog

Avanti makes a complete line of high performance base and mobile CB antennas from \$11.95 to \$373.95.

avanti

RESEARCH AND DEVELOPMENT, INC.
340 Stewart Avenue, Addison, IL 60101

Creators of the famous

MOONBAKER

Circle 90 on reader service card

new products

More information on new products is available from the manufacturers of items identified by a Reader Service number. Use the Reader Service Card inside the back cover.

TWO-SPEED TURNTABLE, model SR-222, is a belt-drive turntable with one-touch control. The motor is a four-pole synchronous type with wow-and-flutter kept down to 0.07%. Signal-to-



noise ratio is 54 dB and rumble is 60 dB. The tonearm is an S-shaped, static-balance type, and the balance weight is continuously adjustable. The turntable is equipped with an anti-skating adjustment and is protected by a hinged dustcover. Suggested retail price is \$115.00.—**Sansui Electronics Corporation**, 55-11 Queens Boulevard, Woodside, NY 11377.

Circle 106 on reader service card

POWERED CB ANTENNA, model CBE-10, is motor driven and can be mounted in the rear deck or fender of any automobile. The unit is made of chrome-plated tubular brass. It weighs seven pounds. With a flick of a switch, the disappearing electric antenna extends to its full

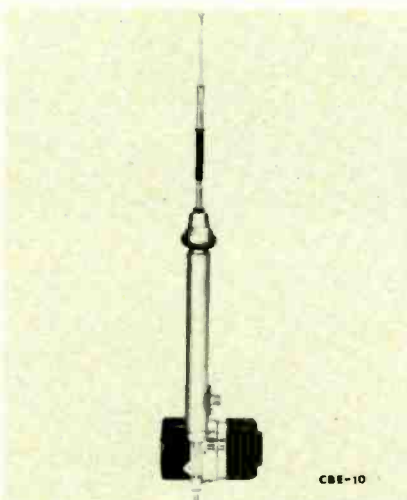

length for its top performance and turns on the CB transceiver automatically. Another flick of the same switch and the antenna with its skinny center-loading coil disappears turning the radio off.—**Tenna Corporation**, 16201 Parkway, Cleveland, OH 44128.

Circle 107 on reader service card

PORTABLE DIGITAL MULTIMETER, model 460-3, features pushbutton selection of 32 overload-protected ranges and functions. A custom-designed MOS-LSI chip provides 0.1% accuracy of reading +1 digit on all DC voltage ranges, plus reliability and low power drain. Includes a calibrated analog meter for nulling, peaking and scanning trends. Digital readout is 0.43" LEDs. 32 ranges include 5 DCV ranges to 1000V, 5 ACV ranges to 600V, 5 low-power ohms ranges to 2 Meg, 5 standard ohms ranges to 20 Meg, 6 DC and 6 AC current ranges to 10 amps. The model 460-3A is \$285, and operates on line voltages of 120/220/240 VAC (50-400 Hz). The 460-3D has a built-in rechargeable battery circuit to permit completely portable operation

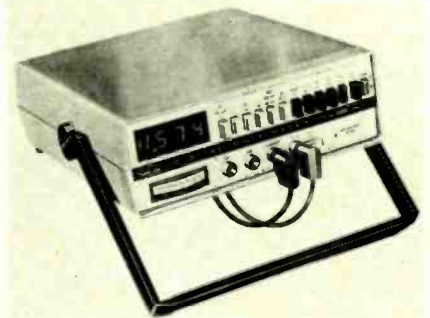

in addition to AC line operation. Its price is \$322, batteries not included.—**Simpson Electric Company**, 853 Dundee Avenue, Elgin, IL 60120.

Circle 108 on reader service card

CB REPAIR KITS. Kit K-936 consists of 37 semiconductors and 16 different types. Kit K-



937 consists of 36 semiconductors and 16
(continued on page 98)

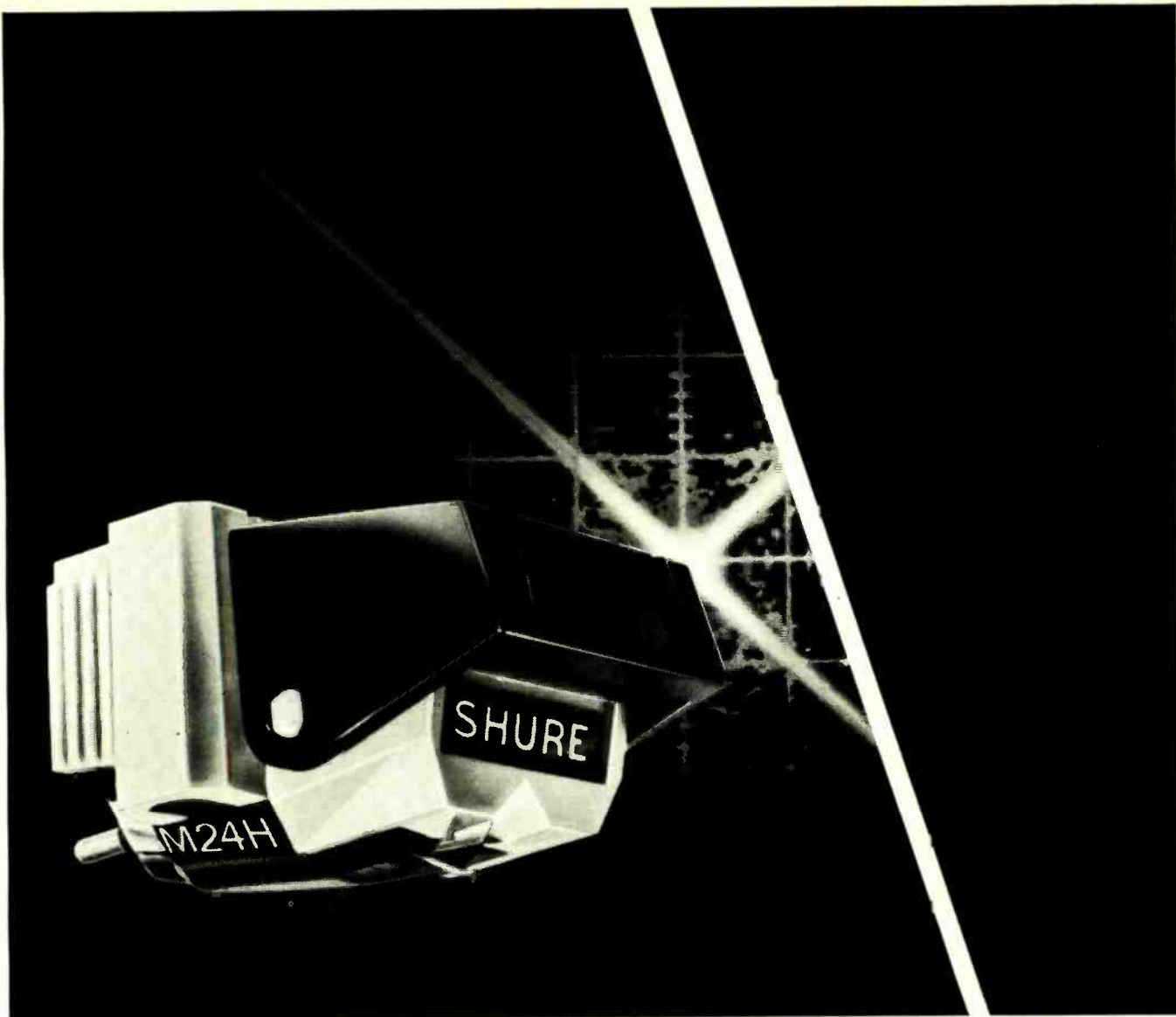

Uncompromised stereo/quadrphony —Undeniably Shure.



The new Shure M24H Cartridge offers audiophiles the best of both worlds: It is the only cartridge on the market that does not compromise stereo reproduction to add discrete quadriphonic capability. It eliminates the need to change cartridges every time you change record formats! This remarkable performance is achieved at only 1 to 1½ grams tracking force—comparable to that of some of the most expensive conventional stereo cartridges. Other M24H features include the lowest effective stylus mass (0.39 mg) in quadrphony, a hyperbolic stylus tip design, an exclusive "Dynetic® X" exotic high-energy magnetic assembly, and a rising frequency response in the supersonic carrier band frequencies that is optimized for both stereo and quadriphonic re-creation. If you are considering adding CD-4 capability, but intend to continue playing your stereo library, this is the ONE cartridge for you.

Shure Brothers Inc.
222 Hartrey Ave., Evanston, IL 60204
In Canada: A. C. Simmonds & Sons Limited



Manufacturers of high fidelity components, microphones, sound systems and related circuitry.

Circle 71 on reader service card

NEW PRODUCTS

(continued from page 96)

different types. Both kits come in a 24-drawer storage cabinet with pull-out drawers. Among the popular CB brands that can be repaired with the G-E Kits are: Air Castle, Allied, Browning, Channel Master, Claricon, Cobra, Courier, Electronic, Fannon, Fieldmaster, Hy-Gain, J.C. Penney, Johnson, Kris, Lafayette, Mark, Midland, PCE, Palomar, Pierce-Simpson, Ray Jefferson, Raytheon, Realistic, Regency, Robyn, SBE, Sharp, Siltronix, Teaberry, Tram and Trutone.—General Electric, Suite 301, 2100 Gardiner Lane, Louisville, KY 40205.

Circle 109 on reader service card

MOBILE AM/CB TRANSCEIVER, model XL-25, has bright LED readout, talkback intercom circuitry, 0.5 microvolt receiver sensitivity, adjacent-channel rejection better than 60 dB, 95%

modulation capability, and 4 watts RF output. Other features include four-position noise-limiter switch, public address, internal/external



speaker switching, delta tuning, RF gain control, squelch control and illuminated S/RF meter. Comes complete with connectors and mounting bracket, plug-in microphone and installation

instructions. \$219.95.—Kris, Inc., Pioneer Road, Cedarburg, WI 53012.

Circle 110 on reader service card

CB CARRYING CASES, Models CB-1 and CB-2, are rugged, lightweight, molded cases for CB equipment and accessories. Protects CB equipment when it's taken in and out of a vehicle. Made of high-density polyethylene with a double wall. Interior is shock absorbent polyfoam. Two



sizes are available, each with a 5-year guarantee. The 12 x 8 1/2 x 4 1/4" case is \$14.95. The 13 1/2 x 10 x 4" case is \$19.95.—Platt Luggage, Inc., 2301 South Prairie Avenue, Chicago, IL 60616.

Circle 111 on reader service card

CB TRANSCEIVER/ANTENNA, model CB-800 transceiver and CA-11 mobile antenna. The transceiver includes LED digital channel-indicator and a pulsing red light for emergency Channel-9. Also features phase-locked-loop circuitry. The CA-11 is a trunk-lip mount type antenna with a three-step telescopic rod that opens to a minimum of 26 inches, to a maximum



of 60 inches. The combination CB-PAK-2 is \$169.95.—Sharp Electronics Corp., 10 Keystone Place, Paramus, NJ 07652.

Circle 112 on reader service card

MULTIPROCESSING SYSTEM, developed for IMSAI 8080 computer, can handle a variety of complex applications, such as high-speed telemetry-data acquisition and reformating, and time sharing with simultaneous batch-processing. Using this technique, as many as six processors can be connected to a single shared memory block (or several noncontiguous memory blocks). Each processor can operate either independently or on a shared basis with one or more I/O peripheral devices. The processors access the shared memory on a priority basis. When two or more processors access the shared memory simultaneously, they are automatically sequenced according to a pre-programmed priority status. The hardware

(continued on page 100)

INTRODUCING THE VERAS F8 COMPUTER THE SYSTEM DESIGNED WITH THE USER IN MIND

A COMPLETE 1K RAM SYSTEM

With CPU card, buffered mother card, power supply and cabinet. The VERAS System is developed around the popular F-8 Series of chips which in our estimation is the finest and most versatile Micro processor now available. The VERAS System can be made into a 17K processor by merely adding four of our optional memory boards.

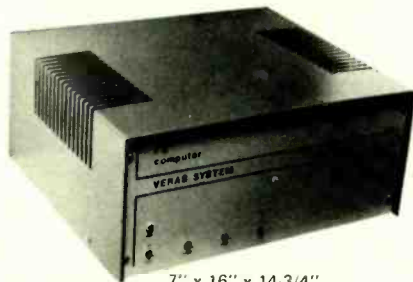

7" x 16" x 14-3/4"

THE CPU BOARD FEATURES:

- Two I/O ports on the CPU and ROM chip make 32 bidirectional TTL lines.
- The 'Fairbug' programmed storage unit provides the programmer with all I/O subroutines, allows the programmer to alter or display memory, and register its contents via teletype.
- Programmable internal timer is built into the ROM chip.
- Built in clock generator and power on reset are built into the CPU chip.
- There is a local interrupt with automatic address vector.
- It is expandable to 65K bytes of memory.
- 20 mil loop and/or RS232 Interface included.
- 1K of on board 2102 RAM.
- Serial interface built into PSU chip.

OUR 4K STATIC RAM BOARD FEATURES: (OPTIONAL)

- Outputs buffered.
- On board decoding for any four of 64 pages.
- Address and data lines are fully buffered.
- 32 2102-1 static RAM's, 500 ns. or less, requiring no refreshing.
- No on-board regulators to cause heat problems. (Chassis mounted)
- 4K memory boards with connector, buffers and static RAM's are available in kit form for \$149.00

The fully buffered mother board will accept (4) 4K RAM boards for a total of 16K bytes of memory. Individual power terminals for each 4K RAM board are provided. Memory expansion beyond 16K bytes can be accomplished by the addition of more mother boards. Extra buffered mother boards with connector are available in kit form for \$45.00

Our modular power supply is designed around a high frequency torroid transformer which affords a large saving in size and weight, and keeps filtering to a minimum. It is rated at +5V at 10 amps and -5V and ±12V at 1 amp. This power supply will drive our CPU, four memory boards and some peripherals.

POWER SUPPLY KIT \$124.00

All boards are high quality G-10, double sided, solder plated with gold plated edge connector.

PACKAGING FEATURES ARE:

- A) Complete modular plug-in construction.
- B) Specifically designed rugged aluminum card rack with provisions for voltage regulators (TO-220 supplied) to keep heat off the boards.
- C) Designed for convection or optional forced cooling.
- D) All I/O ports brought out to the rear panel connectors for easy accessibility.
- E) Auxiliary DC power available at the rear panel to power peripherals.

Veras Systems is currently developing the following: UV PROM board, DMI and DMA board, Cassette, modem, video board and more. All these boards will have innovative design, something you will come to expect from VERAS SYSTEMS.

SPECIAL INTRODUCTORY PRICE FOR THE VERAS F8

Computer kit is \$429.00 or \$679.00 assembled. The price will be \$459.00 after Sept. 15, 1976. The kit includes everything you need to build the VERAS F-8 Computer as described. All boards, connectors, switches, discrete components, power supply and cabinet are supplied. Programming manual, data book and simplified support documentation supplied. 8K Assembler and Editor (paper tape) available on request with minimum order of 8K RAM.

Computer dealers and hobbyist club inquiries are invited.

Expected delivery time 30 days or less.

The More Flexible and Expandable
Computer at a Comparative Price.

VERAS SYSTEMS

Warranty: 90 days on parts and labor for assembled units. 90 days on parts for kits. Prices, specifications and delivery subject to change without notice.

*Fairbug is a registered trademark of Fairchild Corp.

VERAS SYSTEMS
A Div. of Solid State Sales, Inc.
Box 74D, Somerville, MA 02143
(617) 547-1461

Enclosed is check for \$ _____
or Master Charge # _____

VERAS F-8 Computer Kit Assembled
 4K Ram Board Quantity _____
 Power Supply Kit

Name _____
Address _____
City, State _____ Zip _____

Circle 80 on reader service card

THE LOGICAL CHOICE—First in a series

Logic Probe 1 is a compact, enormously versatile design, test and troubleshooting tool for all types of digital applications. By simply connecting the clip leads to the circuit's power supply, setting a switch to the proper logic family and touching the probe tip to the node under test, you get an instant picture of circuit conditions.

LP-1's unique circuitry—which combines the functions of level detector, pulse detector, pulse stretcher and memory—makes one-shot, low-rep-rate, narrow pulses—nearly impossible to see, even with a fast scope—easily detectable and visible. HI LED indicates logic "1", LO LED, logic "0", and all pulse transitions—positive and negative as narrow as 50 nanoseconds—are stretched to 1/3 second and displayed on the PULSE LED.

By setting the PULSE/MEMORY switch to MEMORY, single-shot events as well as low-rep-rate events can be stored indefinitely.

While high-frequency (5-10MHz) signals cause the "pulse" LED to blink at a 3Hz rate, there is an additional indication with unsymmetrical pulses: with duty cycles of less than 30%, the LO LED will light, while duty cycles over 70% will light the HI LED.

In all modes, high input impedance (100K) virtually eliminates loading problems, and impedance is constant for all states. LP-1 also features over-voltage and reverse-polarity protection. Housed in a rugged, high-impact plastic case with strain-relieved power cables, it's built to provide reliable day-in, day-out service for years to come.

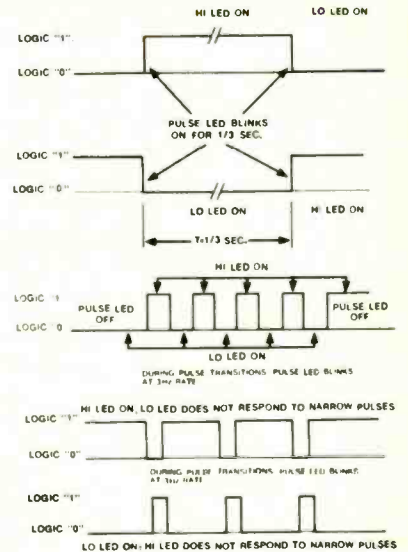

**CSC'S MULTI-FAMILY LOGIC PROBE 1.
AT \$44.95, IT DIGS UP A LOT OF INFORMATION WITHOUT
BURYING YOUR BUDGET.**

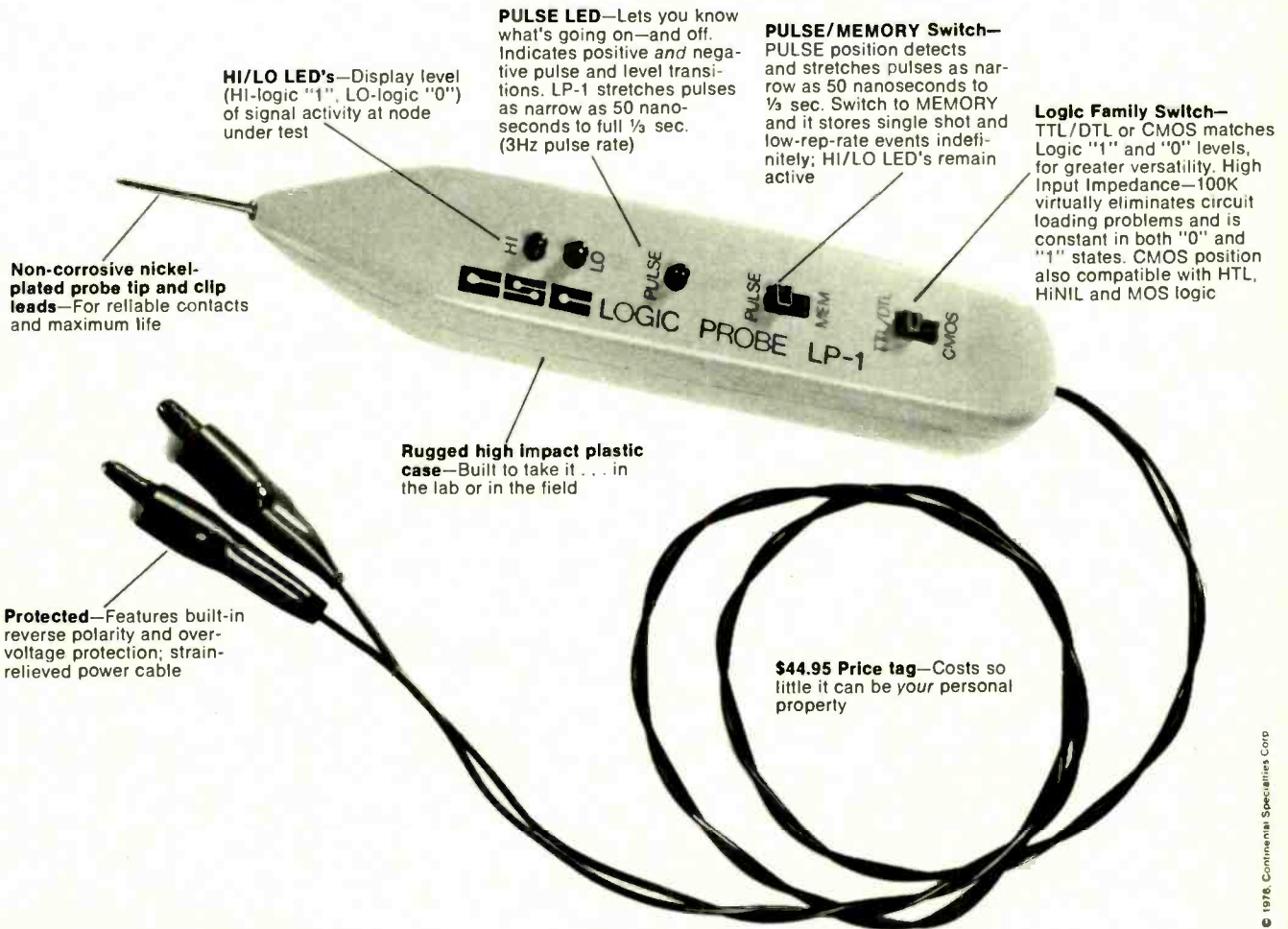

For more information, see your distributor or write for our catalog and distributor list.
44 Kendall St., Box 1942 New Haven, CT 06509 • 203-624-3103 TWX: 710-465-1227 West Coast office:
Box 7809, San Francisco, CA 94119 • 415-421-8872 TWX: 910-372-7992 Canada: Len Finkler Ltd., Ontario

Circle 83 on reader service card

Put safety first ... Use RCA flameproof film resistors .

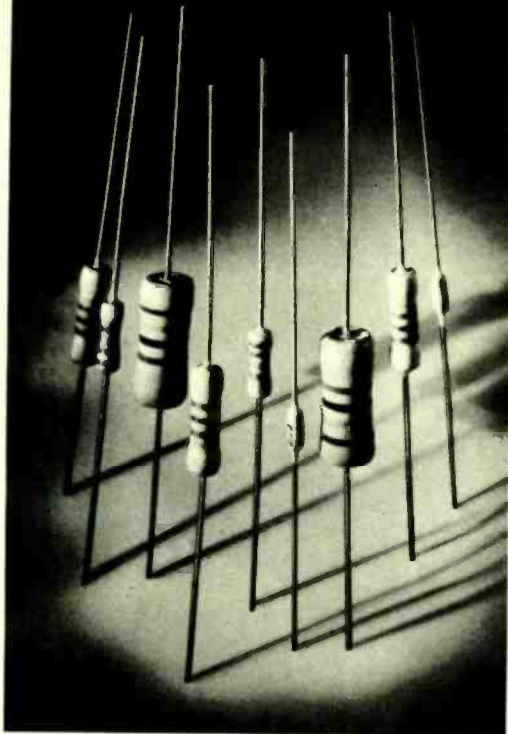

Circle 58 on reader service card

Design engineers prefer them because they won't flame or short under the most severe conditions. Service technicians prefer them because they're safe replacement parts.

RCA flameproof film resistors have a 2% tolerance and are available in 1/4 watt, 1/2 watt, 1 watt, and 2 watt ratings. Resistance values range from 10 Ohms to 1.5 Megohms, depending on wattage rating. Altogether, there are 475 film resistors to choose from.

See your RCA Distributor for all the details, or write to RCA Distributor and Special Products Division, Sales Promotion Services, Cherry Hill, NJ 08101.

RCA

Flameproof Film Resistors

NEW PRODUCTS

(continued from page 98)

required for the multiprocessor logic consists of a bus multiplexing board (\$399 assembled, \$325

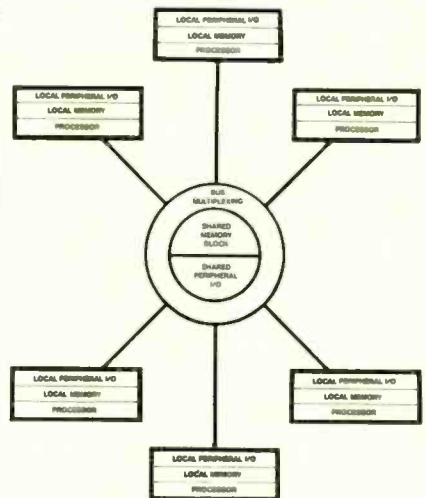

IMSAI 8080 MULTIPROCESSING
COMPUTER SYSTEM

unassembled), a timing and control board (\$305 assembled, \$225 unassembled), and, for each processor, a bus extension board (\$65).—IMS Associates, Inc., 14860 Wicks Boulevard, San Leandro, CA 94577.

Circle 113 on reader service card

NEW SOLDER, Savbit, developed to prevent fine-gauge copper wires and thin copper foils forming the conductive patterns of flexible circuits and printed-circuit boards from dissolving during the soldering operation. This dissolving action, a result of the well known tin-copper



migration phenomena, has frequently caused a wire or thin foil to weaken during soldering, and subsequently break during field use. It is also ideal for applications where copper soldering tips are used because it prevents rapid pitting and wear. Approximately \$3.00 per pound, depending on gauge quantity and world metals prices.—Multicore Solders, Westbury, NY 11590.

Circle 114 on reader service card

MOBILE CB-TRANSCIEVER, model CB 2600, incorporates a sensitive and responsive automatic noise-limiter circuit with time constants so rapid that there is no perceptible time-delay before the circuit counteracts or suppresses noise. Equipped with Delta tuning, backlighted

(continued on page 102)



WORLD'S SMALLEST RECHARGEABLE CALCULATOR...\$19.95! *Does Everything Big Ones Do*

Small but mighty! 8-digit, 4-function electronic calculator even has automatic % key . . . for only \$19.95. Take it anywhere. Carry it in your pocket or purse — it's 2/3 the size of a pack of cigarettes. This 3 1/2-ounce dynamo features floating decimal, constant key, lead zero depression, clear entry, more! At Edmund's low price, the unit comes with a Ni-Cad rechargeable battery pack that can plug into any AC outlet. No need for special recharging adapters. Calculator overall is just 2 x 3 1/2 x 1/8" with plenty of room for most fingers. Another Edmund first with advanced technology. **\$19.95** ppd.
STOCK NO. 1945EH..... Only

GIANT FREE CATALOG!

NEW 164 Pages Over 4,500 Unusual Bargains for Hobbyists. Schools. Industry



JUST CHECK COUPON!

EDMUND SCIENTIFIC CO.
300 EDSCORP BUILDING
Barrington, N. J. 08007
(609) 547-3488

America's Greatest
Science • Optics • Hobby Mart

COMPLETE AND MAIL COUPON NOW

EDMUND SCIENTIFIC CO. 300 Edscorp Bldg., Barrington, N. J. 08007

SEND FREE  

164 PAGE CATALOG "EH"

Charge my BankAmericard

Charge my Master Charge

Interbank No. _____

Card No. _____

Expiration Date _____

30-DAY MONEY-BACK GUARANTEE. You must be satisfied or return any purchase in 30 days for full refund.

City _____

Send me:

ELECTRONIC CALCULATOR(S)

@ \$19.95 ea. (No 1945EH) \$ _____

Service and handling charge \$ _____ \$1.00

Enclosed is

check, m.o. in amount of \$ _____

Signature _____

Name _____

Please print

Address _____

State _____

Zip _____

HELPING TO DEVELOP AMERICA'S TECHNOLOGY FOR OVER 30 YEARS.

Circle 6 on reader service card

Throw out? No!...trade in!

That's right... Here, for the first time, your opportunity to trade in your old, tired, worn out VOM (no matter whose, what model, or what condition) on a new Weston Model 660 series VOM.

The famous "Drop Proofed" champ that is warranted in writing to function completely and satisfactorily even after an accidental fall of up to five feet. A meter mechanism specially ruggedized and a case made of high impact plastic.

The Weston 660 series is renowned for its accuracy, ease of operation, and engineering ingenuity. The movement is diode-protected, a single range switch is used, and all controls are made flush with the edge of the case for extra protection. Unique pluggable circuit boards are used. It can be recalibrated without being removed from its case, can have its fuses replaced externally, and is small enough to fit easily into a tool box or attache case. The light weight, rugged construction, easy to read scales, and hidden carrying handle make the 660

series VOM extremely portable and versatile.

So, if you dropped your VOM and broke it, or if it's just old and tired, join the parade and bring it in to your local Weston distributor. He'll give you up to \$8.50 or more toward the purchase of a new 660 series VOM, the one you've always wanted anyway...the one that's warranted "Drop-Proofed" ...by Weston. That's a really fair trade. So barter up... to a new Weston Model 660 series VOM.

WESTON

WESTON

Schlumberger

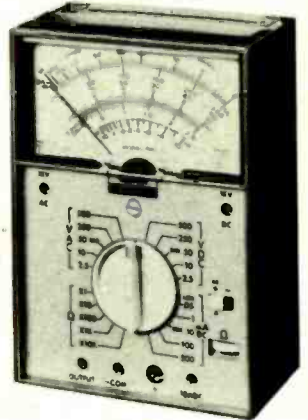

Circle 69 on reader service card

Sphere...

we started at the top and worked our way up!



And we're still working. We were first in the micro-processor computer field to offer a CPU in a complete system. A microprocessor with input, processing and meaningful output.

But we didn't stop there. We had the best product on the market, but we didn't have the best product possible. So our engineers went to work and added more memory and versatility in a rapid succession of advancements, all compatible with the basic product.

We're still on top in the microprocessor field... and through research and development we'll stay on top. At Sphere we're committed to engineering leadership, because in the microprocessor field, you're only on top as long as you're working your way up.

Write for complete information: P.O. 213
Bountiful, Utah 84010
Dept. 101



SPHERE
CORPORATION

Circle 89 on reader service card

NEW PRODUCTS

(continued from page 100)

channel selector, on-air indicator lamp, dual-purpose RF output-power and signal-strength meter, and external speaker jack. Can be used



in any mobile installation with positive or negative ground electrical systems. Price: \$159.00.—**Surveyor Manufacturing Corp.**, 7 Electronics Court, Madison Heights, MI 48071.

Circle 115 on reader service card

DIP EXTRACTOR, model DE180-1, offers a simplified way to remove 14- and 16-pin DIP IC's from printed-circuit boards. It features a precision width, high-mass heating head for maximum pin-contact and heat transfer. All pins are heated uniformly so the IC can be quickly removed when the solder becomes molten. The key to removing the IC is an integral gripping device shaped much like a surgical forceps. The forceps device is spring loaded vertically and

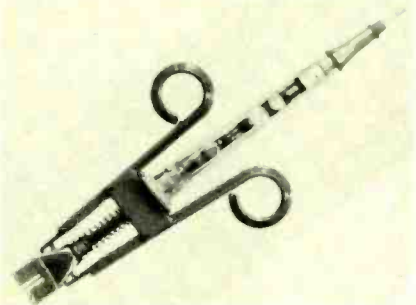

free to rotate 360 degrees about the axis of the heating head.—**Edsyn, Inc.**, 15954 Armita, Van Nuys, CA 91406.

Circle 116 on reader service card

CB REPLACEMENT-SEMICONDUCTOR KIT, model ECG CB10-4, provides replacements for those solid-state devices most frequently subject to failure in Citizen band (CB) transceivers.

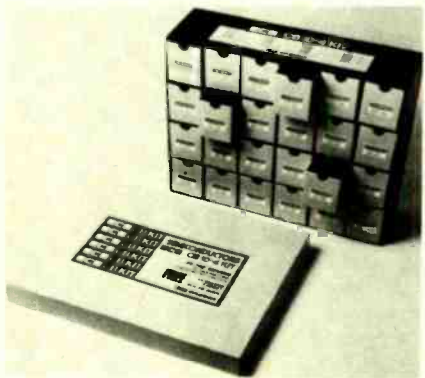

Kit ECG CB10-4 includes 23 transistors and 3 IC's for replacing drivers, modulators, RF output and other semiconductors. Included with the kit is a *CB Replacement Guide* (Bulletin ECG 212F-2). It cross-references more than 3,600 industry part numbers for 44 brands of CB radios in a 20-page booklet.—**GTE Sylvania, Inc.**, One Stamford Forum, Stamford, CT 06904. **R-E**

Circle 117 on reader service card

FREE catalog

over 2000

unique tools,
handy kits,
precision
instruments,
technical
supplies.



Over 24 years of service to the world's finest craftsmen and technicians.

A carefully selected and tested assortment of unique, hard-to-find tools, clever gadgets, precision instruments, bargain kits. One-stop shopping for the technician, craftsman, hobbyist, lab specialist, production supervisor. Many tools and measuring instruments available nowhere else. One of the most unusual and complete tool catalogs anywhere. Get your copy of the **NC FLASHER** today.



National Camera

2000 West Union Ave., Dept. GBA
Englewood, Colorado 80110
(303) 789-1893

Circle 18 on reader service card

FREE burglar — fire alarm catalog



over 900
systems,
detectors,
controls,
sunders,
tools, locks,
supplies

TO PROTECT HOMES, BUSINESSES, INDUSTRY

Huge selection of hard-to-find security equipment from stock. 64 fact-filled pages loaded with 100's of highest quality professional alarm products, technical notes, diagrams.

ONE-STOP SUPERMARKET SELECTION INCLUDES:

ultrasonics, radar, infrared, undercarpet mats, magnetic contacts, smoke & heat detectors; Controls; Alarms: bells, sirens, phone dialers, lights, guard panels. Large selection of tools, relays, wire, holdup alarms, books. Fills need for industry, alarm cos., businesses, homes, institutions. Order your copy today. (Outside U.S. send \$1.00.)



mountain west alarm
4215 n. 16th st.
phoenix, az. 85016
(602) 263-8831

Circle 17 on reader service card

Suddenly, you're the most versatile shop in town.

With this little 25-pound test jig, you can adapt to over 10,000 color sets, 59 different brands. Delta 70° and 90° tube, hybrid, transistor, SCR sweep. Anode voltages to 30kV and more. Regular 4.5kV and 7.1kV focus voltages.

And our new optional In-Line Test Kit lets you handle more than 100

precision in-line chassis, including RCA, Magnavox, Admiral and Sears. (We're the first test-jig manufacturer to offer a kit like this.)

CK3000 comes to you fully assembled, pretested and ready to use.

Just plug it in, and you're in business. See it now, at your Sylvania distributor.

GTE Sylvania, Electronic Components Group, 100 First Avenue, Waltham, Massachusetts 02154.

The Sylvania CK3000



Simply the most versatile test jig you can buy.

GTE SYLVANIA

Circle 36 on reader service card

**CIE has
a terrific idea
for a few people
who know what
they want.**

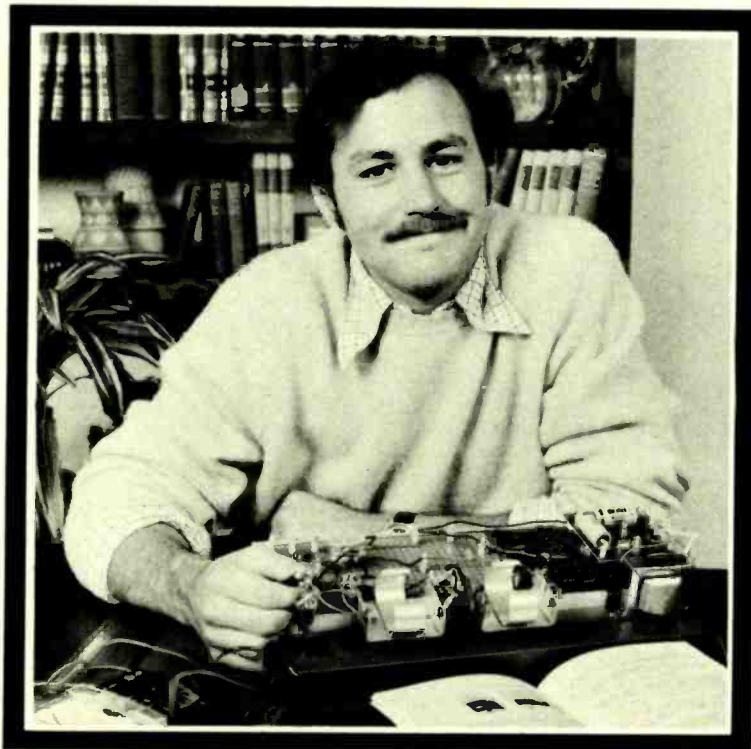

If you want success in electronics . . . if you want the skills people are glad to pay for . . . find out about CIE training. It's a terrific idea that can get you on your way to success in electronics troubleshooting.

Let's face it, learning valuable new skills isn't something you just breeze through. Especially in a modern technological field like electronics troubleshooting. You've got to really *want* success if you're going to build your skills properly.

But, oh boy, the rewards when you do! In today's world, the ones who really *know* electronics troubleshooting find that people . . . even industries . . . look for their help.

What about you? How much do you want the thrill of success . . . of being in demand? Enough to roll up your sleeves and work for it?

Why it pays to build troubleshooting skills.

Suppose the automated production controls on an assembly line break down. Imagine how much money the manufacturer can lose when help doesn't come *fast!* And it takes a skilled electronics troubleshooter to move in . . . locate the problem . . . solve it . . . and get the lines moving again.

Or take a TV station. Breakdowns are costly in broadcasting where time is money. Viewers won't sit forever waiting for sound or the picture to come back. Before they change channels, the station needs to get back on the air again — with the help of a skilled troubleshooter.

No question about it. Building new skills in electronics troubleshooting is an investment in your future. It's well worth the effort.

Why you should get CIE to help you do it.

Troubleshooting starts with *ideas* . . . principles. CIE's Auto-Programmed® Lessons help you get the idea — at your own most comfortable pace. Step by step at home, you explore each principle — each theory — until you understand it thoroughly and completely. Then you start to use it.

How CIE helps you turn ideas into reality.

If you're a beginner, you start with CIE's Experimental Electronics Laboratory. You actually perform over 200 experiments to help you grasp the basics. Plus you use a 3-in-1 Precision Multimeter to get your first taste of the testing, checking, analyzing steps you take in troubleshooting!

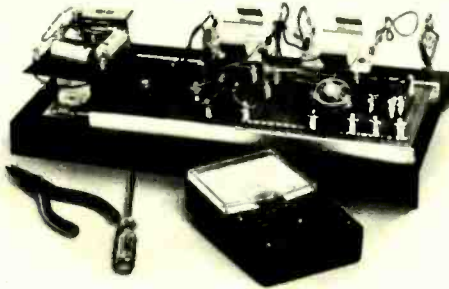

How 3 practical steps help you build troubleshooting skills.

You'll take your first practical step in professional troubleshooting when you build your own 5MHz triggered-sweep, solid-state oscilloscope.

As a trained troubleshooter, you'll use your oscilloscope the way a doctor uses his X-ray machine. As a student, you learn how to "read" waveform patterns on a big, 8cm. x 10cm. screen . . . how to "lock them in" for closer study . . . how to understand and interpret what they tell you.

Your second practical, skill-building step begins when you get your Zenith 19-inch diagonal, solid-state color TV — featuring nine removable modules! Now's your chance to apply the new skills you learned with your oscilloscope!

With CIE's guidance, you perform actual service operations — the kind you'd handle on the job as a trained troubleshooter! Using the TV, you learn to trace signal flow . . . detect and locate malfunctions . . . restore perfect operating standards . . . just as you would with any sophisticated electronics equipment.



Finally, step three rounds out your experience as you work with a completely solid-state color bar generator — actually a TV signal transmitter that produces ten different display patterns on your TV screen!

You study a gated color bar rainbow . . . crosshatch lines . . . dot patterns.

You explore digital logic circuits . . . observe the action of a crystal-controlled oscillator!

This practical, "hands on" training takes concentration and effort. But it's enjoyable and rewarding. And it's a great way to prepare for a troubleshooting career!

Why it's important to get your FCC License.

For some troubleshooting jobs, you *must* have your FCC License. For others, employers often consider it a mark in your favor. It's government-certified proof of specific knowledge and skills!

Almost 4 out of 5 CIE graduates who take the exam get their Licenses. More than half of CIE's courses can prepare you for it . . . and the broadest range of career opportunities!

Free catalog!

Mail the card. If it's gone, cut out and mail the coupon. If you prefer to write, mention the name of this magazine. We'll send you a copy of CIE's FREE school catalog — plus a complete package of independent home study information! For your convenience, we'll try to have a representative call to help you with course selection. Mail the card or coupon . . . or write: CIE, 1776 East 17th Street, Cleveland, Ohio 44114.

CIE Cleveland Institute of Electronics, Inc.

1776 East 17th Street, Cleveland, Ohio 44114
Accredited Member National Home Study Council

YES . . . I want to succeed in electronics. Send me my FREE CIE school catalog — including details about troubleshooting courses — plus my FREE package of home study information!

NAME (please print)

ADDRESS APT.

CITY

STATE ZIP

AGE PHONE (area code)

Check box for G. I. Bill information:
 Veteran Active Duty

Mail today!

RE-84

LEADER TEST INSTRUMENTS

WE MAKE IT EASY FOR YOU TO SERVICE AUDIO EQUIPMENT

for as low as \$139.95



LAV-190 WIDE BAND AUDIO ANALYZER
It's a 3 in 1 Audio generator, Attenuator & AC mVmeter! Has 6 or 600 Ω; dual imped. net., 10Hz — 1MHz freq. range (5 steps) in audio gen. section. Adj. output is 2.5Vrms into 600Ω. Harm. distort. is 0.3%. Attenuator cont. variable with 150μV to 500V AC mVmeter.
With Accessories... \$499.95

LDM-170 AUDIO CIRCUIT DISTORTION METER
Measures dist'n to 0.01%; S/N ratio to 70dB; Signal levels from 100μV to 300V! Has high gain amp. effective to 200KHz; suppresses fundam't'l freq's from 20Hz to 20KHz. Also useful as a pre-amp in low level circuits. Has scope terminal connect.
Excellent Buy \$549.95

LAG-26 LOW DISTORT. SINE/SQUARE WAVE GENERATOR
Tests audio & supersonic freq. ranges! Has low dist'n sine wave & fast rise 0.5μsec. sq. wave for trans. resp. tests. Also used for mod'n & dist. tests. Sync's signals from ext'l source; 200KHz freq. range, 4 bands; 600Ω output imped.
A Real Value... \$139.95

LAG-120 SINE/SQUARE WAVE AUDIO GENERATOR
Tests the most sensitive Hi-Fi! Generates sine & sq. waves from 10Hz to 1MHz with easy push-button freq. range switch'g. Solid State circuit keeps dist. to 0.1%. Has built-in trigger term; switch controlled Freq. ranges; & up to 20dB attenuation.
Portable... \$219.95

LAG-125 LOW DISTORT. AUDIO GENERATOR
For Hi-Fi. amps. speakers, filter nets, etc. Gives clean, sharp sq. waves to trigger pulse gen's. & test trans. resp. Offers burst type signals for speakers. Has dB/V dual scale output meter; push but. freq. range select w/ sync. from ext'l source. 10Hz — 1KHz range flat output. 0.03% distortion.
W/Accessories... \$499.95

LEADER Instruments Corp.

"Put Us To The Test"

151 Dupont Street Plainview, N.Y. 11803 (516) 822-9300

In Canada: Omnitronix Ltd., Quebec

Circle 65 on reader service card

NBS FREQUENCY STANDARD (continued from page 76)

about ten seconds. The exact time may be calculated using the following formula and the information published in the NBS services bulletin:

$$T = \frac{279.36 \times 10^{-9}}{\text{NBS Published Offset}}$$

This determination should be made for each network signal available to increase the confidence in the calibration. As an example, the information published by the NBS for the five days of December 30, 1974 through January 3, 1975 is as follows:

Network	Offset
NBC	- 301.30 × 10 ⁻¹⁰
CBS	- 296.04 × 10 ⁻¹⁰
ABC	- 300.50 × 10 ⁻¹⁰

The resulting values for the calculated period of a rainbow color cycle using the equation above are as follows:

Network	Period
NBC	9.27 seconds
CBS	9.44 seconds
ABC	9.30 seconds

A commercial version of the color bar frequency comparator from the Dynatron Company is shown in Fig. 7. It sells for about \$100.00 and can be used with any color TV. The overall system using the color bar comparator is shown in Fig. 8.

This new system has the potential of exceeding the requirements of most users at a lower cost in time and money. It will be turning up where accurate frequency and time measurements are made **R-E**

CSC'S NEW DESIGN-MATE 4. AN 8-FUNCTION DIGITAL PULSE GENERATOR FOR LESS THAN MOST DVM'S.

Wherever you need crisp, clean, fast output pulses compatible with virtually all logic families and discrete circuits, Design-Mate™ 4 is the logical choice. It produces symmetrical and unsymmetrical pulses ranging from 0.5Hz to 5MHz. And has a 100mV—10V variable output, with rise/fall times of less than 30 nanoseconds plus TTL sink output for up to 40 loads. Pulse width and spacing are independently-controllable from 100 nanoseconds to 1 second (10⁷:1 duty cycle) in seven overlapping ranges. And with the DM-4 you can select continuous operation, manual one-shot or external triggering to 10MHz with synchronous output gating. And a lot more. Which adds up to a high quality clock source, delayed pulse generator, synchronous clock source, manual system stepper, pulse stretcher, etcetera, etcetera, etcetera... minus the 'high quality' price tag.



For more information, see your CSC dealer. Or write for our catalog and distributor list.

CONTINENTAL SPECIALTIES CORPORATION



EASY DOES IT

44 Kendall Street, Box 1942
New Haven, CT 06509 • 203-624-3103 TWX: 710-465-1227
West Coast office: Box 7809, San Francisco, CA
94119 • 415-421-8872 TWX: 910-372-7992
Canada: Len Finkler Ltd., Ontario

Circle 84 on reader service card

FOR MORE INFORMATION CONTACT:

Arbiter Systems
1402 Norman Firestone Road
Goleta, CA 93017

Astro Engineering
2655 Pearl
Boulder, CO 80302

The Dynatron Company
P.O. Box 48822
Los Angeles, CA 90048

U.S. Department of Commerce
National Bureau of Standards
Time and Frequency Division
Boulder, CO 80302



The United Way

Announcing an . . .

Exclusive New Broadband MATV Amplifier

with Automatic Overload Control



Model 3662

Just set it... and forget it.

- Automatic control for input variations of up to 20 dB
 - Eliminates nuisance service calls
 - 45 dB Gain, VHF High Band
 - +52 dBmV Output Capability
 - Separate Lo and Hi VHF band controls
 - Operates at full output rating
 - Switch selectable AOC or MAN operation
 - Lightning protected
 - Universal rack or surface mounting bracket
 - UL listed
- Jerrold Model 3662 is the only broadband MATV amplifier with output signal levels automatically controlled. This exclusive feature permits use of the full output capability of a broadband amplifier without fear of overload due to input signal fluctuations. AOC operates to:
1. Prevent overloading the amplifier when input levels increase.
 2. Increase amplifier gain to compensate for signal fades.
 3. Prevent system cross-modulation even if only one channel level increases or fades.

TRY THE 3662 FOR YOUR NEXT MATV INSTALLATION



JERROLD

a GENERAL INSTRUMENT company

JERROLD ELECTRONICS CORPORATION Horsham, Pa. 19044 • (215) 674-4800

Circle 53 on reader service card

THE MEAN LITTLE KIT

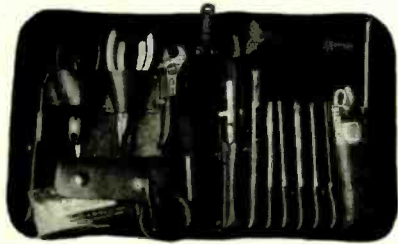

New compact 24-piece kit of electronic tools for engineers, scientists, technicians, students, executives. Includes 7 sizes screwdrivers, adjustable wrench, 2 pair pliers, wire stripper, knife, 2 alignment tools, stainless rule, hex-key set, scissors, 2 flexible files, burnisher, miniature soldering iron, solder aid, coil of solder and desoldering braid. Highest quality padded zipper case, 6 x 9 x 1 3/4" inside. Satisfaction guaranteed. Send check, company purchase order or charge BankAmericard or Mastercharge. We pay the shipping charges.

JTK-6 TOOL KIT..... \$59.50

FREE CATALOG

112 pages of hard-to-find precision tools. Also contains 10 pages of useful "Tool Tips" to aid in tool selection. Send for your free copy today!



JENSEN TOOLS and ALLOYS
4117 N. 44TH STREET, PHOENIX, ARIZONA 85018

Circle 15 on reader service card

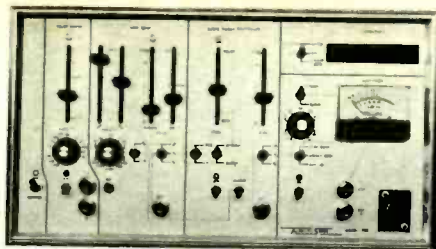

MODEL 100 AUDIO RESPONSE PLOTTING SYSTEM and general purpose sweep/tone burst/pulse generator consists of two sine/square/triangle function generators, pulse generator, frequency counter and peak amplitude measurement sections. It is primarily intended to generate a frequency response plot on an X-Y recorder or scope.

Time base generator offers symmetrical or independent control of the positive and negative sides of the ramp providing a duty cycle of .7% to 99.3%. Frequency range is .0035Hz to 100kHz. Amplitude is 15Vpp into 500 ohms with ± 5 VDC offset. The time base output drives the X axis of an X-Y recorder.

Audio sweep generator provides manual frequency adjustment or log/linear sweep of 20Hz to 20kHz. Blanking mode produces zero reference line on X-Y recorder or tone burst. Amplitude is 15 Vpp into 500 ohms or 10 Vpp into an 8 ohm speaker.

Pulse generator frequency range is .0035Hz to 525kHz. Pulse width is adjusted independent of frequency from 4 seconds to 40 nanoseconds. Outputs are complimentary TTL.

Peak amplitude measurement section measures internal or external signals from mike to power amp level. Amplitude output drives Y axis of X-Y recorder.

Frequency counter is 6 digit, line triggered, and reads either internal or external. Sensitivity is 50 mv peak at 20kHz.

Dimensions: 8 x 14 x 3. Warranty: 1 year. \$525, stock to 30 days.

FIDELITY SOUND

1894 Commerceter W., #105
San Bernardino, Ca 92408
(714) 889-7623

Circle 7 on reader service card

STEP-BY-STEP

(continued from page 79)

50 volts. If this opens, it changes the cathode degeneration drastically. If it develops a high power-factor or leakage, here we go again. The best way of checking this is to lift one end of the capacitor and try a new one. Bridging another one across it may not clear up the trouble.

Follow the cathode circuit and note that it goes to ground *through* the two little controls on the convergence board. So, if one of these is open, one half of the cathode circuit is too. This will change the bias on the vertical output tube, and away we go. If you have just finished fixing a set only to find that now you have a raster only half normal height with distortion, you have probably forgotten to plug in the convergence yoke! A bad socket contact or broken wiring on the convergence yoke plug, socket or board can do the same thing. Incidentally, if you don't see the little 50- μ F electrolytic capacitor on the chassis, keep looking. In quite a few sets you'll find it on the convergence board!

One other problem that is often thought to be in the vertical circuits, but is not, is a light horizontal bar about an inch high. This bar floats slowly up through the picture which is otherwise normal. The root cause of this is in the vertical circuit; it's the good sized pulse of current drawn by the vertical output tube once each field. This is normal. However, if the DC power supply *filter capacitors* are not good enough to take it out, the pulse will get into the video stages and cause the floating bar.

The best test for this is to scope the ripple on the DC power supply. Your pattern should stand still, and not be of a higher P-P voltage than the value shown on the schematic—about 1.5 volts maximum. If this ripple waveform shows a distinct "writhing" or movement, varying when you turn the vertical HOLD control, look out. You have a filter capacitor that isn't doing its job. In well-designed sets, one of the capacitors will be below normal in capacitance. In some of the cheaper sets, the original design may be marginal. In both of these cases, you will have to add more capacitance to get rid of the bar. I have had to add as much as 100 μ F of extra capacitance to get rid of it. R-E

NEWS RELEASE 1976

OFFICIAL TESTING LAB RATES ALLISON #1...
the BEST of ALL Ignition Systems!

The ALLISON "Opto" was Officially Rated #1 by a Foreign Government Testing Laboratory as the BEST "Fuel Saving" Ignition of ALL the Ignition Systems Tested, including Systems with C.D. "add-ons"!

ALLISON

'OPTO XR-700'

with the Exclusive... "Built-In" SOLID-STATE VOLTAGE REGULATOR



★ The "XR-700" is a NEW, redesigned, EASIER TO INSTALL version of the Allison "Opto-Electric", with the New addition of the Voltage Regulator, making it the MOST RELIABLE and Fool-Proof Ignition System ever invented.

★ "XR-700"... Designed for those who want the BEST in Performance, Gas Mileage, Quicker Starting, Eliminate frequent Tune-Ups and Maintenance Costs.

★ Factory-Backed 10-YEAR WARRANTY. (FREE Unit Repair or Replacement on ANY Defects)

★ ORDER WITH CONFIDENCE... Remember, even if you PAY Three Times as much, you cannot get a better Ignition System than the "XR-700"!

★ SAVE! ORDER FACTORY DIRECT. Send Check or M.O., Car-Make, Year, No. Cyl. (4, 6, or 8-Cyl.)

★ You may use your MASTER CHARGE or BANKAMERICARD. Send us (1) Your Number, (2) Interbank No., (3) Exp. Date.

★ MC or BA Card Holders, ORDER by TOLL FREE PHONE: (800) 423-6525, Ext. 2. (When in Continental U.S.A.)

★ Before Buying ANY other Type Ignition System... Send Postcard for FREE BROCHURE.

If you have already installed a "Capacitive-Discharge" Ignition...
★ Convert Your "C-D" Unit to BREAKERLESS!
INCREASE ITS EFFICIENCY with "XR-CD"... Only \$34.95

★ Allison replaced the mechanical Breaker-Points and Condenser with a "Highly Accurate" Optical Control. A Beam of Light, passing through a specially designed "ROTOR" precisely triggers a Heavy-Duty "POWER MODULE" that BOTH "Charges and Fires" the Ignition Coil, with the "FASTEST" High Voltage RISE TIME, producing the MAXIMUM "HIGHEST ENERGY" SPARK available.

★ Since there is NO Mechanical Friction, there are NO Parts to ever WEAR or need replacing, and ONCE properly Timed, it should NEVER need any Maintenance! DWELL never needs adjustment, it is PRE-SET to supply the OPTIMUM Performance at BOTH High and Low Speeds. The RPM Capability of the "XR-700" is Factory Tested to 15,000 RPM.

★ The "High-Energy" SPARK INTENSITY and DURATION... permits the Positive FIRING of Spark-Plugs, even under the MOST ADVERSE conditions, results in more COMPLETE COMBUSTION and Eliminates "Engine Misture", hence fewer exhaust Emissions, IMPROVED Fuel Mileage, a HIGHER Performance Level... and helps keep Plugs FROM FOULING, which greatly extends the Spark-Plug LIFE!

★ Only the Highest Grade (U.S. Made) Solid-State Components are used... UNAFFECTED by Moisture or Vibration! The Allison "XR-700" was engineered to OUTLAST the LIFE OF YOUR CAR!

★ "EASY-TO-FOLLOW" INSTALLATION. (Not Necessary to Dismantle your Distributor.)

★ "CB" USERS: The XR-700 completely ELIMINATES the Major Cause of Primary (Ignition Noise) Interference.

★ America's Oldest and Largest Manufacturer of Opto-Electronic Ignition Systems. ©

ALLISON

AUTOMOTIVE CO.

★ Our BEST Salesmen... are the USERS of our ALLISON Systems!

1267 -E9, East EDNA PL., COVINA, CAL. 91722

Circle 86 on reader service card

Red Cross.
The Good Neighbor.

SCELBI SOFTWARE



Introducing SCALBAL, the new microcomputer language that's simpler than machine language.

A complete language for "8008"/"8080" systems including source listings, routines, flow charts and more!

SCALBAL. SCientific ELementary Basic Language for "8008"/"8080" systems. A complete, illustrated program book. Routines. Techniques. Source Listings. Flow Charts. And more. Took several years to develop. Now yours for many years to come. First time that intimate details of higher level language has been offered for such a low price. Only \$49! You get 5 **Commands**: SCR, LIST, RUN, SAVE, LOAD. 14 **Statements**: REM, LET, IF... THEN, GOTO, FOR with STEP, END, INPUT, PRINT, NEXT, GOSUB, RETURN and optional DIM. 7 **Functions**: INT, SGN, ABS, SQR, RND, CHR, TAB. And, it runs in 8K and more. Here's all the data needed to customize a high level language for your system... at a fraction of the cost!

Order your copy today! Get **\$49** ppd. started advancing your system!



Here's SCALBI's First Book of Computer Games for the 8008/8080. Action-packed. And fun.

Try to beat the computer at its own game. Here's the first complete machine language computer manual for computer games to include source listings, flow charts, routines and more. **Space Capture** — You against the computer using "search and destroy" strategy to shoot down roaming alien spaceships in outerspace. **Hexpaw** — a mini-chess game that lets the computer make mistakes... but only once. **Hangman** — an updated version of the great kid game. Computer selects words at random from long, expandable list. Try to beat it in 8 moves or less. Illustrated. Fun extras to put your computer to challenging, competitive, fun use. **Order yours today! 14⁹⁵ ppd.**

SCALBI's new microcomputer Game Book of Outer Space... **GALAXY**

Captain your own crusading starship against the logic of your "8008" or "8080". You must destroy a random number of alien ships without running out of stardates, out of fuel, out of ammunition or out of the galaxy. Plan your mission. How much fuel is used for your warp factor? Don't run into roaming stars that can damage your ship. **Suddenly! Condition Red! Alien in sight!** How big is he? Fire a phasor or torpedo! He's damaged or destroyed. But, you've used valuable fuel. That's just the beginning. A new game every time. Complete program book in machine language for 4K memory, including source listings, flow charts, routines, etc. Great intergalactic adventure and fun.



Order "GALAXY" today! **14⁹⁵ ppd.**

"8080" SOFTWARE MANUALS

Three new basic, complete "MUST" manuals! "8080" Assembler Program operates easily in 4K bytes of RAM (including symbol table). Unique feature: How to accept mnemonics related to "8008" based machines on "8080". Includes all major routines, pertinent flow charts, highly com-

mented assembled listing and more. **\$17.95.** "8080" Editor Program identical to "8008" Editor, with machine codes for "8080". **\$14.95.** "8080" Monitor Routines same functions as "8008" specifically developed to utilize expanded capabilities of "8080". **\$11.95.**



SAVE \$5.35! BUY ALL 3 FOR ONLY \$39.50!



MACHINE LANGUAGE PROGRAMMING FOR THE "8008"

(and similar microcomputers)

Here's the detailed, basic manual you need to develop today's machine language programs. 170 pages. Illustrated. Easy-to-read, understand. Most techniques applicable to other micro-computers, including "8080". Floating-point arithmetic package is worth the price alone!

Order today!

19⁹⁵ ppd.

- Detailed presentation of "8008" codes • Flow Charts
- Mapping • Floating-point Package • Debugging
- Basic programs: loops, counters, masks
- Organizing Tables • Editing/Assembling
- Math operations • I/O, Real Time Programming
- Maximizing memories • And lots more.

Master Charge, Postal and Bank Money Orders preferred. Personal checks delay shipping up to 4 weeks. Pricing, specifications, availability subject to change without notice. Prices for U.S. and Canadian delivery at book mailing rate. Add \$2.50 for each publication if Priority Air Service (U.S.) desired. Foreign orders add \$6.00 for each publication.



SCALBI COMPUTER CONSULTING INC.

1322 Rear Boston Post Rd., Milford, CT 06460
Telephone: 203/874-1573

Circle 25 on reader service card

QUICK CHARGE IRON- QUICK CHANGE TIPS

ISO-TIP® Quick Charge Cordless Soldering Iron recharges in 3-4½ hours. Uses any of **Wahl's 16 snap-in tips.**

Low voltage, battery powered, ground free isolated tip design.

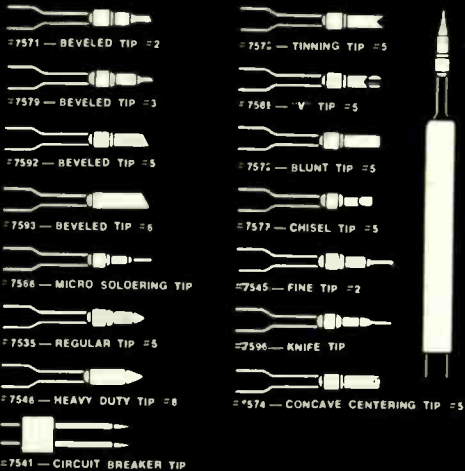

7556 TUNER EXTENSION TIP



WAHL CLIPPER CORPORATION
ORIGINATORS OF PRACTICAL CORDLESS SOLDERING
Sterling, Illinois 61081 (815) 625-6525
"Manufacturing Excellence Since 1919"

Circle 21 on reader service card

If you don't need it for forever, don't build it for forever.

Here's an application for our ACE solderless breadboards you may not have thought of.

Next time you only need a circuit for a little while, build it up on an ACE. There's an ACE the right size for almost any circuit you have to build. And ACE's a more reliable solderless breadboard, so your circuit can stay functional for as long as you need it together. Then, when your need for the circuit disappears, just disassemble it and use everything over again. It's all good as new.

And what's true for ACE is also true for our versatile A P Super-Strips™, Terminal and Distribution Strips.

So if you have a special application circuit that you won't need around forever—a test jig, a set-up-and-calibrate hookup, you name it—put ACE to work for you. The time you save may be your own. ACE. The All Circuit Evaluator from A P Products.

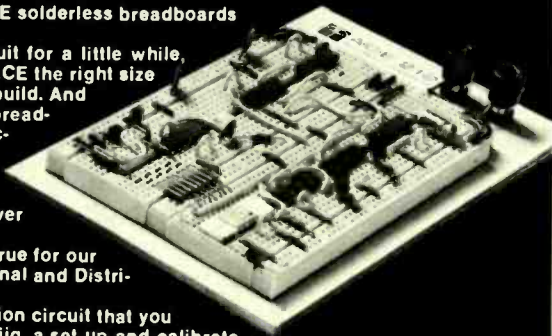

Part No.	ACE Model No.	Tie Points	DIP Capacity	No. Buses	No. Posts	Board Size (Inches)	Price Each	Qty.	Total
923333	200-K (kit)	728	8 (16's)	2	2	4-9/16x5-9/16	\$18.95		
923332	208 (assem.)	872	8 (16's)	8	2	4-9/16x5-9/16	28.95		
923334	201-K (kit)	1032	12 (14's)	2	2	4-9/16x7	24.95		
923331	212 (assem.)	1224	12 (14's)	8	2	4-9/16x7	34.95		
923326	218 (assem.)	1760	18 (14's)	10	2	6-1/2x7-1/8	46.95		
923325	227 (assem.)	2712	27 (14's)	28	4	8x9-1/4	59.95		
923324	236 (assem.)	3648	36 (14's)	36	4	10-1/4x9-1/4	79.95		

ACE solderless breadboards feature gold-anodized aluminum base/ground plates, non-corrosive nickel-silver terminals and four rubber feet.

Credit Card Number _____

4 Numbers Above Name (MC) Good Thru _____

Signature _____

Print Name _____

Address _____

City _____ State _____ Zip _____

- Check or M.O. enclosed
- Charge BAC
- Charge MC
- Send catalog



Total for merchandise _____

Sales Tax (OH and CA) _____

Shipping (see table) _____

TOTAL ENCLOSED _____

Shipping/Handling

Up to \$10.00 \$1.00

10.01 to 25.00 1.50

25.01 to 50.00 2.00

50.01 to 100.00 2.50

100.01 to 200.00 3.00

Company PO's FOB Painesville No COD orders

DEALER INQUIRIES INVITED.

Orders subject to acceptance at factory.

STATE OF SOLID STATE

(continued from page 36)

are useful—they are a viable way to get going—but you're going to find programming with them eventually a tiring and unproductive procedure.

Incidentally, a control panel switch register is not as easy to implement with micro as it is with minis. The various registers are not discrete as in the mini and can not be reached by wiring directly to them. Programs must be written and stored that fetch and display data or alter register contents.

Breadboarding and evaluation packages are available in different orders of sophistication and price. Money-making projects with a commercial product as a goal may justify spending 2 to 10 thousand dollars on an evaluation and design system. These finely polished systems include RCA's Microkit, Motorola's EXORciser, and National's PACE microcomputer.

If on the other hand you are working on a low production item or simply are in the learning or hobby phase (along with most of us), you will probably want to spend a minimum. You can use evaluation modules that the larger manufacturers use as the basis for their breadboarding systems, or you can go to one of the smaller producers and get started for around \$200.

Software

Don't forget to consider software. It may be available with the breadboarding kit, from the microprocessor manufacturer or from an independent organization. Software may be free or have a moderate price tag. Software comes as a simple program listing on paper, or on magnetic or paper tape that is loaded directly with a peripheral input device.

You must have software to do an effective job. It should be considered an equal partner with hardware in a microcomputer system. Hundreds of hours of experienced effort are consumed in its development, so it is not wise to try to duplicate the effort. Later on you may be able to make additions or modifications to the software package on your own. And I certainly encourage dissecting the software and learning what makes it tick. Figure 1 (top right) shows the elements of software packages. Very few systems include all the pieces shown.

One way to write a program is directly in machine language. Keeping the instruction list nearby, take a piece of paper or a programming pad, figure out what you want to do and list the machine code line by line. This can be a listing in octal or hexadecimal, but the program will be entered into the machine, in binary. The only exception to this is when hardware or resident software does a number conversion.

At the other end of the scale are the most sophisticated operating systems. These systems, upon cue of terminal commands, automatically load processors or programs into memory from peripherals such as cassette tape. There are also stand-alone operating systems with a monitor that keeps all the programs in memory simultaneously and selectively starts the one of interest. Operating systems used in microcomputers are generally simple because of the tendency for limited memory space. They still do a powerful, nontrivial job.

(text continues on page 114)

A P PRODUCTS INCORPORATED

Box 110-R Painesville, OH 44077 (216) 354-2101

Circle 2 on reader service card

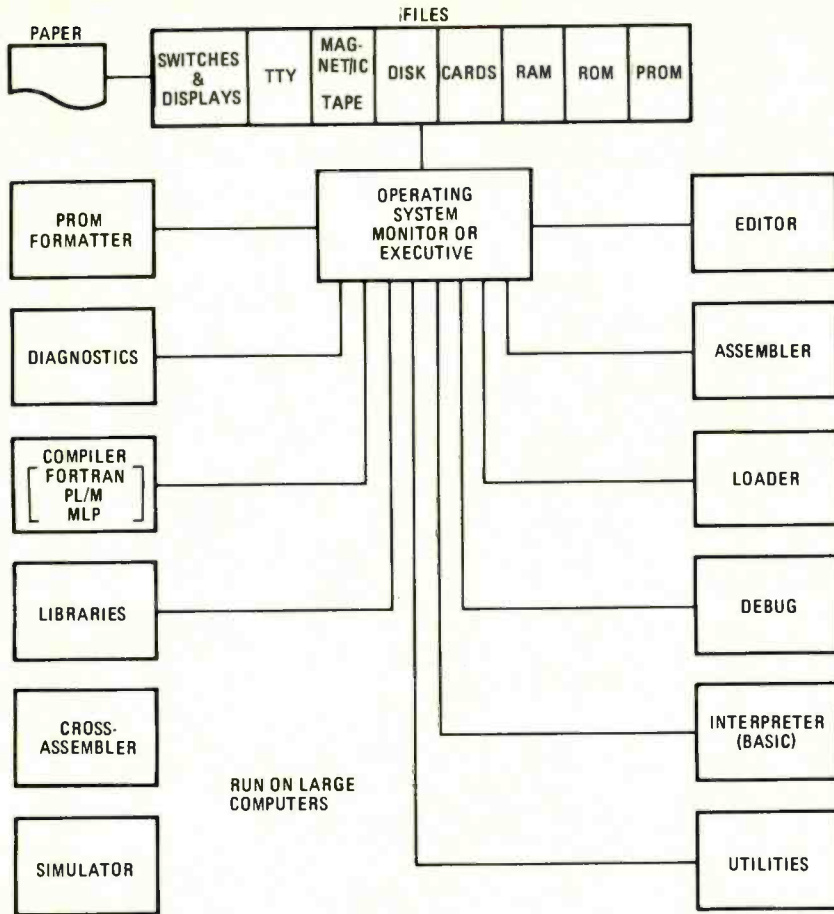

FIG. 1—SOFTWARE operating system components.



EVERY DEALER
NEEDS A
Levelite[®]
INSTANT TV SIGNAL INDICATOR

Levelite is not just a new product, it's a great new patented profit maker for distributors. About the size of a pocket calculator, it is invaluable for troubleshooting TV antenna and MATV systems. Every dealer will want to carry one with him on service calls, so he can instantly isolate the trouble either to the set or the antenna.

Jerrold is advertising the new Levelite heavily in dealer magazines. Be sure you stock it and display it.

JERROLD 
a GENERAL INSTRUMENT Company

Horsham, Pa. 19044 • (215) 674-4800

Circle 54 on reader service card

Consumer Tested Remedy for Sick Car Performance Sparks New Life in Pre-1975 Cars.

Owners of pre-1975 cars get better performance with less maintenance when they install one of the Mark Ten C.D. Electronic Ignition Systems. In fact, thousands of users testify the Mark Ten has noticeably improved their automobile's performance. As a California doctor stated after using the Mark Ten for 95,000 miles. "...I can 'feel' the difference in performance between my conventional ignition and the Mark Ten..."

Mark Ten Systems* spark each plug with 50,000 to 60,000 volts in secondary output compared to a mere 25,000 volts in standard and most pointless systems. This means dramatic increases in acceleration and general engine performance, and substantial increases in gasoline mileage. Points will last the lifetime of the rubbing block. Spark plug life is extended three to ten times due to the hot spark generated by the Mark Tens, which eliminates fouling and cleans dirty plugs. And the Mark Ten Systems virtually eliminate at least 2 out of 3 tuneups! Look at what Delta Customer P.S. from New York wrote, "...I might add that I had another unit of yours that has been on three cars so far. Each of the cars was driven about 50,000 miles

before it was turned in. *Not one of the cars ever had a new set of points, new plugs or a tune-up.*

Now its on the fourth car with 20,000 miles on it and going strong." The result? **BIG SAVINGS!**

Send today for your copy of the new Delta brochure and learn how a Mark Ten System can spark your car into new life.

*Only Delta Products offers a full line of C.D. ignitions: The Mark Ten and Mark Ten B, available assembled or in kit form; and the Mark Ten C, assembled only.



Circle 49 on reader service card

DELTA PRODUCTS, INC.
P.O. Box 1147
Grand Junction, Colo. 81501
(303) 242-9000 Dept. RE

I want to know more about Mark Ten CDI's. Send me complete no-nonsense information on how they can improve the performance of my car.

Name _____
Address _____
City _____ State _____ Zip _____

Incredible counter!

Incomparable price!

A 500mHz (6-Digit) **FREQUENCY COUNTER** for under 40 cents per mHz! Figure it out. It adds up to unheard-of savings! With guaranteed quality to match and exceed overpriced brands. Let us prove it to you now!

169⁹⁵

\$199.95 assembled

(6-DIGIT/500mHz KIT)
FREQUENCY COUNTER



Perfect for: CBers, Hams, Service Techs, & Experimenters!

• HAM, CB, & COMMERCIAL BANDS • WIRED & TESTED AVAILABLE • 100HZ READOUT • 6 DIGITS
• CRYSTAL TIME-BASE • 1Hz OPTIONAL • MASTER CHG. / B. AMERICARD OK • ADD \$2 SHIPPING

Hufco

Incredible counters starting at \$45.95 are also available!
All counters can be factory wired and tested. Write or call today!
Box 357, Dept. 62, Provo, UT 84601 (801) 375-8566

Circle 78 on reader service card

STATE OF SOLID STATE

(continued from page 112)

Programming is also done on large time-shared or dedicated computers. The completed program is then simulated on the same large machine. A large computer speeds the job but there are some serious shortcomings to the approach. A large computer cannot completely simulate the final microcomputer system. Timing and I/O interfaces are peculiar to the specific micro and cannot be simulated. Time-shared computer time and dedicated computer overhead is also expensive. Before any program is indelibly written onto a ROM mask, it must be checked by running on its eventual host machine.

Operating system modules

First you need some kind of file system. You will need to store the components of the software package and the programs you are developing. In the most elemental systems, the program is entered via front-panel switches so that the switch positions can then be read and transferred to paper—a file system of sorts. Punched paper tape is a much better long-term storage medium. File storage is also necessary for saving the programs at various stages of editing and assembly. Random-access memory in sufficient quantity is ideal for intermediate storage because of the high speed with which the programs can be shuffled back and forth. Let's look at some file handling examples:

Processor Technology sells a software operating system package designated package No. 1 for the 8080. They assume you have a microcomputer system running with facilities for entering their program. An executive routine carries out commands typed into the terminal. It costs only \$3 as a program listing—looks like a bargain. 6,000 bytes of memory are required for its routines plus the additional space needed to store the source and object user programs.

Assume that the four programs are already stored in RAM. Maximum capacity of the system is six files. These files should not be limiting since this is short-term RAM storage. To find out how the four are cataloged, type the FILES command. The software directs the printer to list the names and their memory locations.

Motorola's EXORciser development system is built around their M6800 evaluation module. EXbug, the resident control program is stored in 1,000 bytes of ROM. Directed from a teletype or RS-232C terminal, EXbug can load programs or search a tape for a specific one. The LOAD command starts the program entry sequence.

Programs stored in ROM or PROM are called firmware—they are nonalterable software. They are less expensive than hardware implementation of the same function since the only thing they require is allocated memory space and the ROM itself. Firmware is also less expensive than software because, in quantity, ROM is cheaper than RAM. And there is no need to worry about destroying the firmware program during execution of a defective program.

The JOLT system built around MOS Technology's MCS6502 also uses firmware. To read in from a high-speed tape reader, simply type LH for load hexadecimal. The monitor does the conversion into binary.

Now that the program has been loaded from a storage medium or has been typed in

Money Generator

PAT. PEND.

\$299.95



ATC-10 GENERAL TELEVISION SERVICER

- Extra wide range RF/IF attenuator for testing receiver sensitivity.
- HATCHDOTS - versatile composite pattern for dynamic & static convergence plus other checks.
- COLOR BARS pattern with 6th bar marked to make your job easier.
- 3.58 MONITOR pattern for oscillator frequency checks with no need to short the AFPC test point.
- RED RASTER pattern for checking and adjusting purity at the flip of a switch.
- High level, 75 ohm output provided.
- ◆ 2 year factory warranty.
- ◆ 30 day money back guarantee.
- ◆ 2 volume owner's manual available separately - \$1.00.

Unique

One of the most useful, UNIQUE patterns of the ATC-10 is the GRAY QUAD pattern below. Use it for checking and adjusting gray scale tracking or for checking effects of video level upon horizontal sync. Use it to check for reversed yoke connections - vertical, horizontal or both. Use it to check low frequency video response. *It can save you time, trouble and money!* Write us.

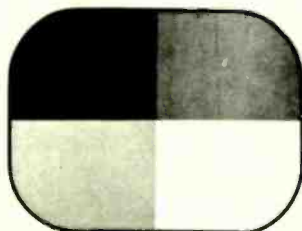

American Technology Corporation

225 Main Street, Dept. 9C, Canon City, Colorado 81212

Credit card & COD phone orders accepted. Same day shipment. (303) 275-8991, ext. 3.

Circle 51 on reader service card

fancy typewriter—much like automatic correcting office typewriters.

A common operation is to delete lines. Sometimes the program is modified so a smaller number of lines replace an original larger group. One or more lines have to come out. All the lines after the deleted lines are moved up displacing the old characters. Overwriting is the normal computer operation rather than erasing. Pointers keep track of where everything is. File deletions are sometimes done by just erasing the listing. As memory space becomes short because of deleted files, a pack command then crams the active programs together overwriting the dropped files.

Processor Technology uses the DELT (delete) command followed by the line numbers. Each line is prefixed with a line number by the user. To change a single line, simply rewrite that line number along with the updated text. Separating line numbers by 5 or 10 when you enter text initially allows you to go back and make insertions by using intermediate line numbers.

Motorola's Exbug has an I command for insertion of text. It also has a string-search feature to find a sequence of characters anywhere in the workspace buffer.

The contents of the editor buffer is called TEXT since the editor is an English text handling program. Whether you are writing machine code or a trip report doesn't make any difference to it. You may be writing in binary, hexadecimal, assembly language, or a high-level language depending on what the next step of program development is. Figure 2 shows the inputs and outputs of the main operating system components.

If an assembler is part of your package, program writing using the editor will be done in shorthand mnemonics. Things become much simpler. Instead of committing the machine code to memory including all the variations of addressing, you use more easily remembered mnemonics like ADC for add with carry.

The next step is assembly. The assembler is loaded and the editor mnemonic text output fed through it. Each assembly language statement has a number of fields. The label field holds the symbolic statement name if any, the operation field contains the instruction mnemonic or assembler directive, the argument field holds operands and the comment field is used for documentation. A good programmer includes nonexecutable comments to help himself and others recall what was done.

In one or more passes over the mnemonics, the assembler produces binary object code ready for loading into the computer for execution. A listing of the program is typed out matching the machine code to the mnemonics. More sophisticated assembly programs run on the larger computers will produce cross-references and symbol tables. During editing, program steps are given names such as BEGIN or NEXT. Alphabetical table listings printed by the assembler tell you where the tagged statements are located in memory. The cross-references give the locations of all instructions that refer to labeled statements. Assembly listing make life a lot easier when troubleshooting or analyzing programs.

Most assemblers produce error diagnostics—messages that call out common mis-

takes. It is easy for an assembler to know that you typed ADB instead of ADC if ADB is not a valid instruction mnemonic and is not in the assembler's internal instruction list.

Assembled programs are put into memory with a loader. Absolute loaders take a program and store it in the specific memory addresses assigned by the programmer. Many programs must be able to run in different segments of memory. Relocatable loaders are called into play. You must realize that programs contain specific addresses in their instructions. If an instruction says JUMP NEXT and NEXT is located at address 4200, the actual instruction will be the machine code equivalent of JUMP 4200. The relocatable loader not only puts the instruction into memory step by step, but first modifies the code so that it will run where it is loaded.

The loader will often start the program. Otherwise, the CPU program counter is changed to the address of the first instruction and the computer is started manually or through the terminal monitor software.

Debugging procedures are now used to find out why the program does not do what it is supposed to or why it doesn't run at all. Firmware or software debuggers set traps or breakpoints by replacing instructions with halt commands. The program runs until it reaches the suspected trouble spot where the breakpoint has been inserted. Registers and memory are then examined to see what went wrong. Corrections are made by returning to the editor and assembler. Without an assembler, if an instruction has to be added, each statement would have to be moved up a slot throughout the entire

(continued on page 119)

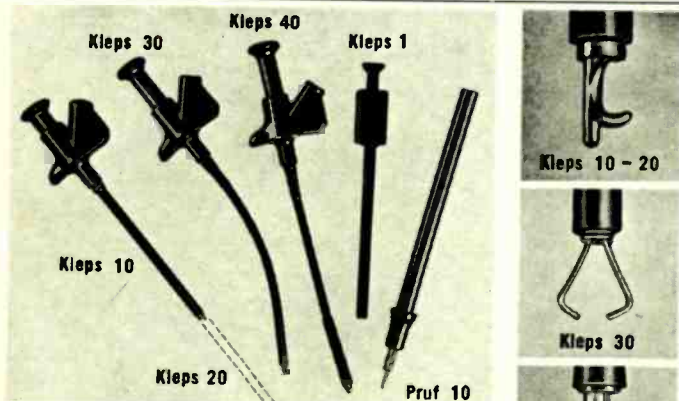

Clever Kleps

Test probes designed by your needs—Push to seize, push to release (all Kleps spring loaded).

- Kleps 10.** Boathook clamp grips wires, lugs, terminals. Accepts banana plug or bare wire lead. 4¾" long. **\$1.39**
- Kleps 20.** Same, but 7" long. **\$1.49**
- Kleps 30.** Completely flexible. Forked-tongue gripper. Accepts banana plug or bare lead. 6" long. **\$1.79**
- Kleps 40.** Completely flexible. 3-segment automatic collet firmly grips wire ends, PC-board terminals, connector pins. Accepts banana plug or plain wire. 6½" long. **\$2.59**
- Kleps 1.** Economy Kleps for light line work (not lab quality). Meshing claws. 4½" long. **\$.99**
- Prof 10.** Versatile test prod. Solder connection. Molded phenolic. Doubles as scribing tool. "Bunch" pin fits banana jack. Phone tip. 5½" long. **\$.89**

All in red or black - specify. (Add 50¢ postage and handling). Write for complete catalog of - test probes, plugs, sockets, connectors, earphones, headsets, miniature components.

Available through your local distributor, or write to:

RYE INDUSTRIES INC.
125 Spencer Place, Mamaroneck, N.Y. 10543
In Canada: Rye Industries (Canada) Ltd.

Circle 67 on reader service card

How to:

Did you ever want to know how to manage your money to make every penny count?

You can learn how to do it.

We're the Consumer Information Center of the government. And our free catalog lists over 200 booklets, brochures, and publications that tell you how to do a lot of different things.

You'll find brochures about growing vegetables in tiny gardens. About food and nutrition. Home repairs, health and recreation. Even about buying a used car.



Free catalog.

How to get the catalog that lists them all?

Just write Consumer Information Center, Pueblo, Colorado 81009.

WEIRD PROBLEM

I've got a really weird problem in an RCA CTC-52. The horizontal and vertical sync are very jittery, and I get small bright wormy lines in the center of the screen. The edges of the raster seem to pull in where the lines are, but the picture is jumping around so fast I can't be sure. Wow! Checked filters, etc.; no help.—E.G., Umpire, AR.

You have got a problem. Try this: this is a "dual-feed" horizontal oscillator supply circuit. The oscillator is started by a connection to B+ but runs on a DC voltage coming from boost. Check the two resistors going from the oscillator plate back to boost. These should be 270K and 120K, and you will probably find that both of them have gone away down in value. The loss of load impedance is actually making the oscillator "drop out" so that you lose horizontal sweep, then start up again. This makes the "wormy lines" in the middle of the screen. A lot like "Christmas-Tree" in the older sets.

REPEATED CAPACITOR FAILURE

This Admiral 3C3591 came in with C111, 300 pF, on the damper cathode burnt up. I replaced it. Worked fine. Sent it home and it came back in three weeks with the same capacitor burnt up, and no other problems! I need a permanent fix!—C.G., Albuquerque, NM.

Apparently this has happened to others. I have an *Admiral Service Note* saying that this capacitor must be replaced with an exact duplicate, with the right temperature coefficient and voltage rating. The Admiral part number of this is 65A10-457—300 pF ceramic disc, 10%, with a 6 kV rating.

RCA LISTING OF RCA TYPES!

I have a solid-state RCA TV. The audio output transistor, X10, is given as "2444", and this is what was in the set. However, I can't find a substitute listed in any of the transistor guides, even RCA's! What the heck?—J.L., Bridgeport, OH.

The "2444" is a "device number". You'll find all of the transistors in this set listed in the RCA SK replacement guide. Look for them under the RCA stock number. In this case, this would be 116075. An RCA SK-3021 will replace this; case and everything match.

TV SOUND IN RADIO

Give me a good idea on how I can pick up TV sound on a radio. I like to listen to some programs without watching them—L.S., Miami, FL.

I know what you mean. I have a couple of programs like that, too! There are several ways. I think the easiest and cheapest would be to use one of the little "wireless mike" modules fed from the top of the TV volume control, etc. You can get these for AM or FM. The FM might be better because the AM unit might pick up harmonics from the TV sweep. See any of the "little ads in the back of the book" in any issue of R-E, or look at radio-TV supply houses for the modules.

REPEATED FAILURE

I got a Sears 562.10523 color set. When it came in, the 30KD6 and 23JS6 tubes were bad. Replaced them, and it ran about a month. Came back with the 23JS6 high-voltage regulator bad. Replaced it again, and it was back in two weeks! Same thing. The high-voltage, cathode current, etc., are all in spec. I don't get it.—P.C., Salem, WV.

Neither did I, the first few times I heard of this. Thanks to Monty Huckle of Lake Tahoe, CA, we found the reason! The 23JS6 tubes used in these are a special EIAJ (Electronics Industries Association of Japan) type, with a much higher heater-cathode breakdown voltage than the EIA (U.S.) 23JS6 type! So, a perfectly good American 23JS6 won't stand up. You'll have to get the Japanese type replacement from the factory. We covered this in a Reader Question some time ago, but it seems to need a "re-run". Watch out for this. R-E

Put Professional Knowledge and a COLLEGE DEGREE in your Electronics Career through HOME STUDY

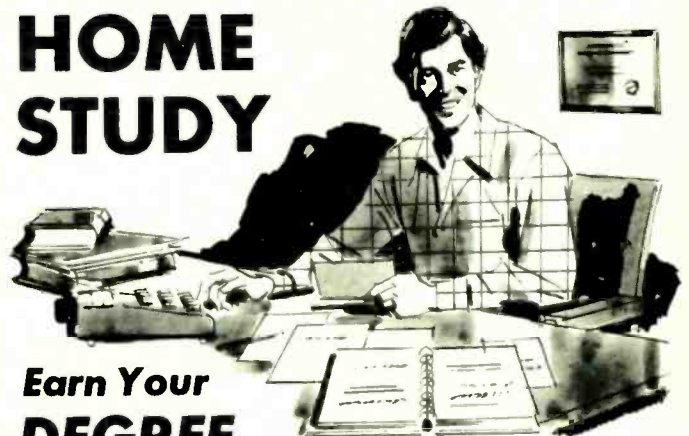

Earn Your DEGREE

by correspondence, while continuing your present job. No commuting to class. Study at your own pace. Learn from complete and explicit lesson materials, with additional assistance from our home study instructors. Advance as fast as you wish, but take all the time you need to master each topic. Profit from, and enjoy, the advantages of independent study.

The Grantham correspondence degree program in electronics is comprehensive. It begins with basics, written in very simple language, and continues through the B.S.E.E. degree level. Throughout the entire program, heavy emphasis is placed on clear explanations written in great detail, progressing from the simple to the complex, in easy steps.

Our free bulletin gives complete details on the curriculum, the degrees awarded, the requirements for each degree, and how to enroll.

GRANTHAM SCHOOL OF ENGINEERING

2000 Stoner Ave., Los Angeles CA 90025

● Telephone (213) 477-1901 ●

Worldwide Career Training thru Home Study

Mail the coupon below for free bulletin.

Grantham School of Engineering RE 9-76
2000 Stoner Ave., Los Angeles, CA 90025

I have been in electronics for _____ years. Please mail me your free bulletin which gives details concerning your electronics degree programs.

Name _____ Age _____

Address _____

City _____ State _____ Zip _____

Circle 11 on reader service card

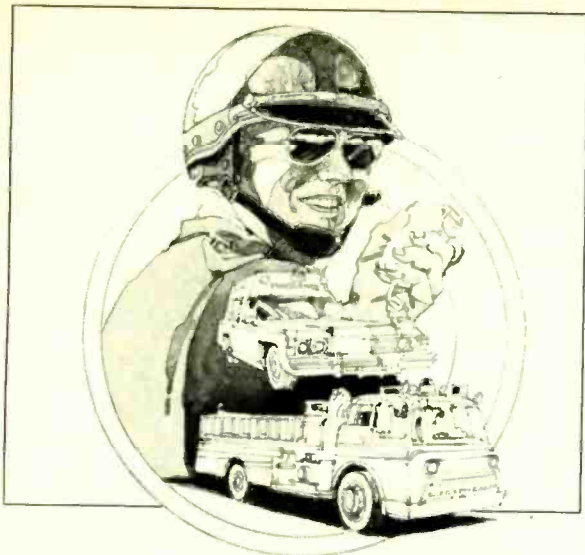

INTERNATIONAL FM 2400CH

FREQUENCY METER for testing mobile transmitters and receivers



- Tests Predetermined Frequencies 25 to 1000 MHz
- Extended Range Covers 950 MHz Band
- Pin Diode Attenuator for Full Range Coverage as Signal Generator
- Measures FM Deviation

The FM-2400CH provides an accurate frequency standard for testing and adjustment of mobile transmitters and receivers at predetermined frequencies.

The FM-2400CH with its extended range covers 25 to 1000 MHz. The frequencies can be those of the radio frequency channels of operation and/or the intermediate frequencies of the receiver between 5 MHz and 40 MHz.

Frequency Stability: $\pm .0005\%$ from $+50^\circ$ to $+104^\circ\text{F}$.

Frequency stability with built-in thermometer and temperature corrected charts: $\pm .00025\%$ from $+25^\circ$ to $+125^\circ$ (.000125% special 450 MHz crystals available).

Self-contained in small portable case. Complete solid state circuitry. Rechargeable batteries.

FM-2400CH (meter only) \$595.00
 RF crystals (with temperature correction) 24.00 ea.
 RF crystals (less temperature correction) 18.00 ea.
 IF crystals catalog price

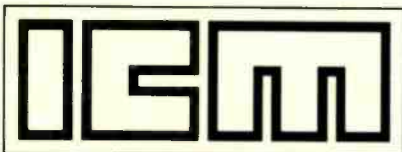

International Crystal Manufacturing Company, Inc.

10 North Lee, Oklahoma City, Oklahoma 73102

Circle 85 on reader service card

next month

OCTOBER 1976

■ CB Technical Feature

Synthesizers—what they are and how they work.

■ SWR Made Easy

How it affects your CB operations and how to make the best of it.

■ AM Stereo

It's new and may be all over the US soon. Here's a preview of this new kind of sound.

■ Build Digicolororgan

A really special kind of color organ that turns sound into color in your music room.

■ Elcaset

New jumbo cassette takes $\frac{1}{4}$ -inch tape, runs at a higher speed and permits the use of multiple tape heads.

■ PLUS

Mystery Of The Tweeters

Overspeed Circuits For Your Car

Mindpower: Alpha

Lab Tested Hi-Fi Reports

Delayed Sweep—How To Use It

Step-By-Step Troubleshooting

State Of Solid State

Komputer Korner

Jack Darr's Service Clinic

STATE OF SOLID STATE
(continued from page 116)

program. Then there is the problem of correcting addresses and off-page references. For a program of larger than about 100 statements, you will be pretty unhappy.

When the program is finished, you will either file it away or produce an output to program a ROM or PROM. Small volume applications, those under 100 systems where the mask charges for ROM are too high, will probably use PROM in the final product.

Some programmable read-only-memory can be programmed only once. Microcomputer systems usually use the reprogrammable type. They are erased by exposure to ultraviolet light. To change a single bit, the entire PROM is erased and is totally reprogrammed including the modified bit. Operating systems may include PROM formatters to produce output tapes that will control external programming machines. Typical program flow during program generation is illustrated in Fig. 3.

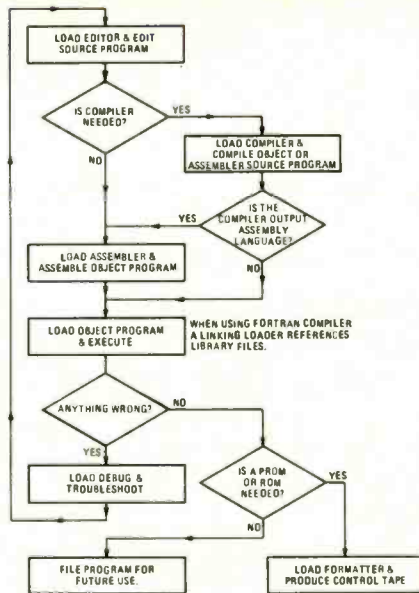

FIG. 3—PROGRAM FLOW during program generation.

Micro notes

Electronic Product Associates compact microcomputer, the Micro-68, comes with a keyboard, LED display, 512 words of PROM, 128 words of RAM and a power supply. The 512 word John-Bug PROM lets you load programs, inspect and edit them, and insert breakpoints. It sells for \$430. 8K-byte static-memory boards for the 8-bit machine are

\$270. Built around the Motorola M6800 it has a \$28.50 MIK-BUG ROM option.

An assembler, 64K memory board, PROM programmer, television adapter and cassette tape recorder are in the works. Electronic Product Associates, Inc., 1157 Vega Street, San Diego, CA 92110.

Motorola and Hitachi have announced that Hitachi will join AMI in second sourcing the M6800 NMOS MPU family including software, firmware, and the EXORcisers.

National Semiconductor is delivering production quantities of the 16-bit PACE microprocessor for Hamilton-Avnet's PACER desk-top microcomputer.

The build-it-yourself machine sells for \$685 in kit form. It features a new type keyboard to enter programs directly into memory and two 4-digit alphanumeric displays to analyze data and programs.

Vector Electronics 4350 plugboard will supply up to two voltages to a wide variety of microprocessors and interface circuits. The 7 x 9.6" (178 x 244 mm) board holds 14-, 16-, 24- and 40-pin DIP's. The 4350 was originally developed for TI's 9800 series of computers. Vector Electronic Company, Inc., 12460 Gladstone Avenue, Sylmar, CA 91342.

MITS Computer Notes is a publication of the Altair Users Group. Software and operating notes and a Q & A column on the Altair 8800 and 680 lines are featured. New products and information on the 8080 BASIC interpreter are presented. 4K, 8K, and Extended BASIC is available for \$150, \$200 and \$350, respectively. 4K, 8K, or 12K Altair 8800's with an I/O board lowers the prices to \$60, \$75, or \$150. MITS, 6328 Linn NE, Albuquerque, NM 87108. R-E

BETTER THAN A THIRD HAND!



PANAVISE TILTS, TURNS, AND ROTATES TO ANY POSITION. IT HOLDS YOUR WORK EXACTLY WHERE YOU WANT IT. PanaVise has great strength yet is gentle enough to firmly hold delicate objects.

Quite possibly the finest new tool you will buy this year, PanaVise is built to exacting professional standards. We guarantee it!

Illustrated is the Electronics Vise Model 396. Three other bases and a wide variety of heads are available. All interchangeable! Buy a basic unit, then add on to create your system.

Available through your dealer. Write for a free catalog.

PANAVISE Dept. 5E
10107 Adella Ave., South Gate, CA 90280
In Canada: 25 Toro Rd., Downsview, Ont. M3J 2A6

A Division of Colbert Industries

Circle 27 on reader service card

For faster service

USE ZIP CODE

on all mail

EIGHT INSTRUMENTS IN ONE

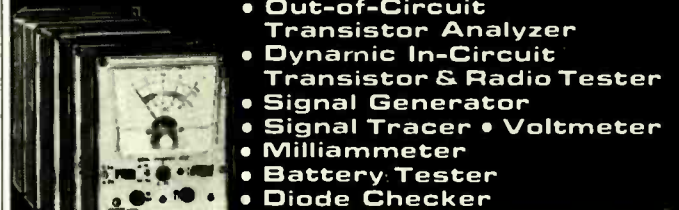

- Out-of-Circuit Transistor Analyzer
- Dynamic In-Circuit Transistor & Radio Tester
- Signal Generator
- Signal Tracer • Voltmeter
- Milliammeter
- Battery Tester
- Diode Checker

Transistor Analyzer Model 212

Factory Wired & Tested—\$28.24
Easy-to-Assemble Kit—\$19.21

YOU DON'T NEED A BENCH FULL OF EQUIPMENT TO TEST TRANSISTOR RADIOS! All the facilities you need to check the transistors themselves — and the radios or other circuits in which they are used — have been ingeniously engineered into the compact, 6-inch high case of the Model 212. It's the transistor radio troubleshooter with all the features found only in more expensive units. Find defective transistors and circuit troubles speedily with a single, streamlined instrument instead of an elaborate hook-up.

Features:
Checks all transistor types — high or low power. Checks DC current gain (beta) to 200 in 3 ranges. Checks leakage. Universal test socket accepts different base configurations. Identifies unknown transistors as NPN or PNP.

Dynamic test for all transistors as signal amplifiers (oscillator check), in or out of circuit. Develops test signal for AF, IF, or RF circuits. Signal traces all circuits. Checks condition of diodes. Measures battery or other transistor-circuit power-supply voltages on 12-volt scale. No external power source needed. Measures circuit drain or other DC currents to 80 milliamperes. Supplied with three external leads for in-circuit testing and a pair of test leads for measuring voltage and current. Comes complete with instruction manual and transistor listing.

EMC, 625 Broadway, New York 12, N. Y.

Send me FREE catalog of the complete value-packed EMC line, and name of local distributor.

NAME _____ RE-9

ADDRESS _____

CITY _____ ZONE _____ STATE _____

EMC

ELECTRONIC MEASUREMENTS CORP.
625 Broadway, New York, N. Y. 10012

R-E TESTS JVC S-300
(continued from page 68)

Using our spectrum analyzer for successive frequency sweeps, it becomes a simple matter to visually illustrate the capabilities of the S.E.A. (graphic equalizer) circuits of the JVC S-300 receiver (see Fig. 5) but the true flexibility and usefulness of those five slide controls can only be appreciated by using them during actual listening and use tests. Figure 5 illustrates only the extreme settings

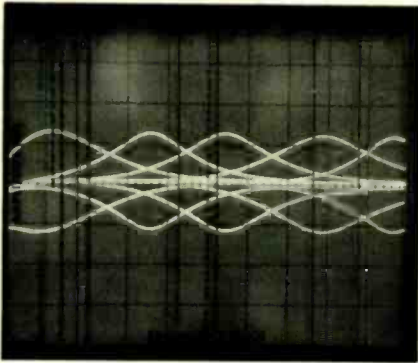

of each of the five controls, but of course an almost limitless variety of response curves can be set up with the equalizer controls to suit any listening requirement and to compensate for just about any kind of acoustic or equipment limitations that are present, within reason.

One minor criticism of JVC's brochure is

in order. In it, they imply that the end controls (those that govern boost or attenuation of 40 Hz and 15 kHz) may be considered to be low and high cut filters, as well as tone controls. Certainly, when placed in their most downward positions these levers will attenuate the region of frequencies around the nominal center points named, but as can be clearly observed from the scope traces in Fig. 5, output tends to be restored beyond the range of these controls. Thus, the 15-kHz level provides maximum attenuation at 15

kHz, but output rises again beyond 15 kHz—hardly the action expected of a low-pass high cut filter.

The same is true of the 40 Hz lever. Below 40 Hz, output increases even if that lever is pushed down to its greatest attenuating position. This is perhaps a minor point, and one not worthy of serious criticism, but we get the feeling that JVC felt guilty at not having been able to include separate low and high cut filters at this price and so they elected to assign "double duty" (at least verbally) to

RADIO-ELECTRONICS PRODUCT TEST REPORT

Manufacturer: JVC

Model: S-300

AMPLIFIER PERFORMANCE MEASUREMENTS

POWER OUTPUT CAPABILITY

RMS power/channel, 8-ohms, 1 kHz (watts)	58.0
RMS power/channel, 8-ohms, 20 Hz (watts)	54.0
RMS power/channel, 8-ohms, 20 kHz (watts)	56.0
RMS power/channel, 4-ohms, 1 kHz (watts)	70.0
RMS power/channel, 4-ohms, 20 Hz (watts)	N/A
RMS power/channel, 4-ohms, 20 kHz (watts)	N/A
Frequency limits for rated output (Hz-kHz)	14-43

R-E
Measurement

R-E
Evaluation

DISTORTION MEASUREMENTS

Harmonic distortion at rated output, 1 kHz (%)	0.065
Intermodulation distortion, rated output (%)	0.18
Harmonic distortion at 1 watt output, 1 kHz (%)	0.027
Intermodulation distortion at 1 watt output (%)	0.026

0.065
0.18
0.027
0.026

Excellent
Very good
Superb
Excellent

DAMPING FACTOR, AT 8 OHMS

53

Very good

PHONO PREAMPLIFIER MEASUREMENTS

Frequency response (RIAA ± dB)	-0.4, +0.5
Maximum input before overload (mV)	220
Hum/noise referred to full output (dB) (at rated input sensitivity)	71 (78 wtd)

-0.4, +0.5
220
71 (78 wtd)

Good
Very good
Excellent

VIDICONS

TOP QUALITY AT LOW, LOW PRICES

- 8823/8844
- 20PE13A
- 8929/20PE19
- 7735A
- 7262A
- 7038
- 20PE11

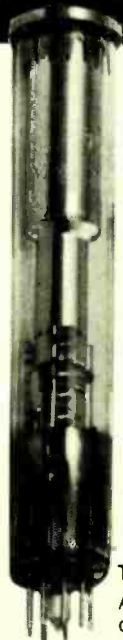

Fully
Guaranteed
in
Factory Sealed
Cartons!

8758A only
\$42.00 ea.*

8507
8541A only
\$61.95 ea.*

only
\$29⁵⁰
ea.*

*in lots of five or more
(any mix). For less
than 5 add 10%.

Terms: Check with order.
Add \$2.00 for shipping
charges.

GBC CLOSED CIRCUIT TV CORP.
"World's Largest CCTV Supplier"

74 FIFTH AVE. • NEW YORK, N.Y. 10011 • (212) 989-4433

Circle 50 on reader service card

**NEW! An absolutely LEGAL way
to Pull In Distant, Weak
CB Signals!**



● MAKES
INCOMING
CB SIGNAL VOLTAGE
10 TIMES STRONGER

● PERMITS "WALL-TO-WALL"
CB RECEPTION FROM MUCH
GREATER DISTANCES

● MAY BE USED WITH BOTH AM AND SSB

● FAIL-SAFE. AUTOMATICALLY BY-PASSED WHEN
TURNED OFF AND WHEN TRANSCIVER TRANSMITS

● CAN BE USED WITH NEG. OR POS. GND

● CONNECTS EASILY BETWEEN CB XCVR & ANTENNA



Our business is improving yours!

Circle 38 on reader service card

those end sliders on the graphic-equalizer arrangement.

Listening tests

Our overall product analysis as well as our reactions during listening tests of the S-300 will be found in Table II.

Our view is that JVC has managed to cram a great many circuit features and flexible switching and program source selection into a medium-priced receiver that offers excellent value for its price.

TABLE III

HIGH LEVEL INPUT MEASUREMENTS		
Frequency response (Hz-kHz, \pm ___ dB)	15-53, 1.0	Very good
Hum/noise referred to full output (dB)	85 (97 wtd)	Excellent
Residual hum/noise (min. volume) (dB)	90 (102 wtd)	Excellent
TONAL COMPENSATION MEASUREMENTS		
Action of bass and treble controls	see Fig.	Not applicable
Action of secondary tone controls	see Fig. 5	Superb
Action of low frequency filter(s)	see Fig.	Not applicable
Action of high frequency filter(s)	see Fig.	Not applicable
COMPONENT MATCHING MEASUREMENTS		
Input sensitivity, phono 1/phono 2 (mV)	2.7/	
Input sensitivity, auxiliary input(s) (mV)	190	
Input sensitivity, tape input(s) (mV)	190	
Output level, tape output(s)	190	
Output level, headphone jack(s) (V or mW)	N/A	
EVALUATION OF CONTROLS, CONSTRUCTION AND DESIGN		
Adequacy of program source and monitor switching		Very good
Adequacy of input facilities		Very good
Arrangement of controls (panel layout)		Excellent
Action of controls and switches		Excellent
Design and construction		Very good
Ease of servicing		Good
OVERALL AMPLIFIER PERFORMANCE RATING		
		Excellent

Latest hand-held calculator computes common fractions

The AL-8, recently introduced by Casio, is the world's first calculator that can compute with ordinary fractions. It has a number of other extraordinary features, two of the most striking being the ability to calculate in circular measure units (degrees, minutes and seconds) and computing standard deviations.

The 8-digit calculator handles the four basic functions, has a percent key and a full 4-key independent memory (allowing addition, subtraction, recall and clearing of the memory). But in addition, it has two slide switches with special functions. The one at the left under the display in the photograph cuts off or rounds decimals to two places. The longer one, at the right in the photo, has six positions marked with special codes: The first position (left to right) computes the square root. The next position, GT (Grand Total) is used with the memory to compute horizontal and vertical totals. The REM (Remainder) position enables the user to divide one number by another, determine the integer number of times that the first number can be divided by the second, and by pressing a key display the remainder. The fraction position enables the user to add, subtract, multiply and divide fractions. The next position is for sexagesimal calculations, those dealing with degrees, minutes and seconds. It can also be used for measuring time intervals expressed in hours, minutes and seconds. The last position is for calculating the standard deviation.



Antenna, Incorporated
 U.S. MANUFACTURERS OF
**THE BEST IN
 CITIZENS BAND
 ANTENNAS**

ZAPPER
 MODEL 13510
 BASE LOADED
 MAGNET MOUNT
 \$28.88

MATCHLOCK
 MODEL 13511
 CENTER LOADED
 MAGNET MOUNT
 \$28.88

MAGNET MOUNT

Antenna, Incorporated
 23850 Commerce Park Road, Cleveland, Ohio 44122
 (216) 464-7075
 In Canada: E.S. Gould Marketing Co., Ltd.
 109 Montee De Liesse Montreal, Quebec H4T 1S9 Canada
 Antenna, Incorporated, International Division
 P.O. Box 1002 Rockville Centre, New York 11571

For
 faster
 service

USE
 ZIP
 CODE

on
 all
 mail

Circle 96 on reader service card

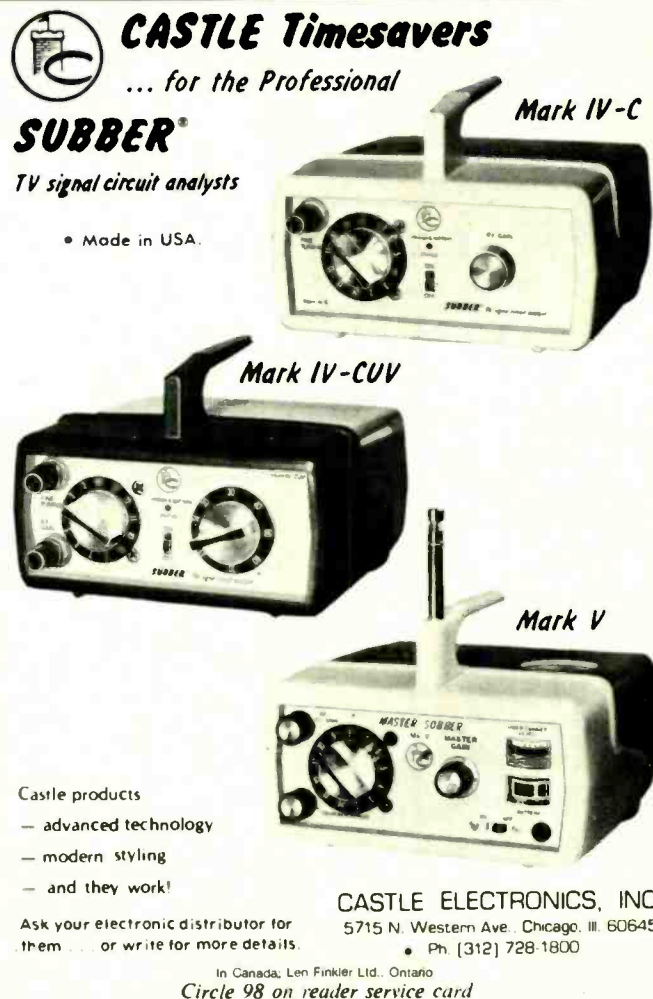

CASTLE Timesavers
 ... for the Professional

SUBBER®
 TV signal circuit analysts

• Made in USA.

Mark IV-C

Mark IV-CUV

Mark V

Castle products
 — advanced technology
 — modern styling
 — and they work!

CASTLE ELECTRONICS, INC.
 5715 N. Western Ave. Chicago, Ill. 60645
 • Ph. (312) 728-1800

In Canada: Len Finkler Ltd., Ontario
 Circle 98 on reader service card

market center

NEW

Wafers are meant to be inserted in a .063" maximum thickness board and have .043" diameter pins on .156" centers.

CATALOG NUMBER	DESCRIPTION	PRICES	
		1-10	11-99
13.0001	12 pos. rt. angle connector	.60	.50
13.0002	12 position wafer	.60	.50
13.0003	9 pos. rt. angle connector	.60	.50

SPECIAL!
1000 Molex IC terminals for \$7.50
2000 for \$13.50

SPECIAL!
Motorola 741 Mini Dip
35g-10 for \$3.00

ELECTROLYTIC CAPACITORS

PLEASE ORDER IN MULTIPLES OF 5 PER ITEM
RADIAL LEADS

WORKING CAPACITANCE (uF)	VOLTS DC	PRICE
10	16, 35, 50	.16
20	16, 35, 50	.16
30	16	.16
50	16, 35	.22
100	16, 35, 50	.25
200	16	.22
500	16	.34
1000	16	.52
2200	16	.80

Specify ONE

LINEAR

NE501A	2.80
NE555A	.50
A710CA	.60
A741V	.40
A747CA	1.10
A748CV	.74
A723CA	1.00
MC1468L	3.90

Red Lead & Mtg. Hardware
11-3/4

	1-10	11-100
	.35	.29

MINIATURE FILM CAPACITORS

VALUE (uF)	1-10	10-50	51-100
.001	.14	.10	.06
.0047	.10	.10	.06
.01	.10	.10	.06
.05	.19	.17	.15
1	.20	.18	.16
22	.25	.23	.21

These units are made by International Components Corp. All units 100 V

FIXED POWER SUPPLY KITS

Specifications	F2618	F1210	F1816
Input Voltage (50-500Hz)	105-125v	105-125v	110-125v
Output Voltage	5v ± 5%	12v ± 5%	15v ± 5%
Output Current (I _o ± 25% C)	1.5A Max.	1.5A Max.	1.1A Max.
PRICE	\$14.00	\$14.50	\$14.50

INDEFINITE SHORT CIRCUIT PROTECTION. Price includes Pre-wired G10 Board, All Parts and Transformer.

DISPLAY BEZELS

CATALOG NUMBER	FILTER COLOR	PRICE	DIMENSIONS 1/8" C
905-80	Red	\$2.75	1.37
910-80	Red	2.80	2.00
915-80	Red	2.90	3.00
920-80	Red	2.90	4.00
920-70	Amber	2.95	4.00

These bezels are heat resistant plastic with a black matte finish. Filters are circular or polarized type.

SOCKETS
LOW PROFILE
These sockets are from TI.

NUMBER OF PINS	5-99	100
8	.21	.18
14	.25	.23
16	.28	.24
24	.40	.35
28	.50	.45

TRANSISTORS

2N3638A	P	5	TO-92	.25
2N2222A	N	5	TO-18	.20
2N5133	N	.05	TO-18	.25
2N5494	N	7.00	TO-220	1.05
2N4401	N	60	TO-92	.60
2N4403	P	60	TO-92	.30
TIP32	P	3.00	TO-220	1.05

TRIMMER POTENTIOMETERS
These are 5/8" diameter thumbwheel trimmer potentiometers.

VALUES OHMS	PRICE TABLE
100 500 1K 5K 10K 20K 25K 250K 500K 100K 500K 1M 5M	1.10 1.00 1.00
	.30 .20 .27

BAG OF 50 MOLEX PIN NESTERS
7 pin style \$1.00
8 pin \$2.25

MOLEX IC TERMINAL
100 for \$1.00 300 for \$2.80 500 for \$4.20
700 for \$1.80 400 for \$3.40 800 for \$5.00

700 for \$5.80 900 for \$7.40
800 for \$6.80 1,000 for \$8.20

Ref of 50,000 \$ 2,270.00

REGULATOR CIRCUITS

MC7805CP	5 volt regulator @ 1.5A max.	1.99
MC7812CP	12 volt regulator @ 1.5A max.	2.00
MC7815CP	15 volt regulator @ 1.5A max.	2.00

16 Page Catalog 25¢

DIODES

1N4001	10/51.00
1N4002	10/51.00
1N4148	10/51.00
1N5401	5/\$2.00 (SA, 1000/PK)

1N746-739A \$ 3.30 ea

TRACY DESIGN CORP.
15870 SCHAEFER • DETROIT, MI. 48227 • (313) 838-2501

CLASSIFIED COMMERCIAL RATE (for firms or individuals offering commercial products or services) **\$1.40 per word** . . . minimum 15 words.

NONCOMMERCIAL RATE (for individuals who want to buy or sell personal items) **85¢ per word** . . . no minimum.

ONLY FIRST WORD AND NAME set in bold caps. Additional bold face (not available as all caps) at 10¢ per word. Payment must accompany all ads except those placed by accredited advertising agencies. 10% discount on 12 consecutive insertions, if paid in advance. All copy subject to publisher's approval. Advertisements using P.O. Box address will not be accepted until advertiser supplies publisher with permanent address and phone number. Copy to be in our hands on the 26th of the third month preceding the date of the issue (i.e. August issue closes May 26). When normal closing date falls on Saturday, Sunday or a holiday, issue closes on preceding working day.

BUSINESS OPPORTUNITIES

HIGHLY PROFITABLE ONE-MAN ELECTRONIC FACTORY

Investment unnecessary, knowledge not required, sales handled by professionals. Ideal home business. Write today for facts! Postcard will do. Barta-BI, Box 248, Walnut Creek, CA 94597.

EDUCATION & INSTRUCTION

LEARN Basic Digital Troubleshooting by correspondence. **EDUCATIONAL TECHNOLOGIES**, Dept. RE, Box 224, Reynoldsburg, OH 43068

ELECTRONIC MUSIC SYNTHESIS/ANALOG PROCESSING

- PLANS & KITS
- CIRCUIT THEORY
- INDUSTRIAL R&D TECHNIQUES
- PARTS & COMPONENTS

featuring: STATE-OF-THE-ART technology, and professional-lab quality designs at **LOW COST BUILD**: • Ultra wide range universal V.C.O. • Voltage controlled filters & amplifiers • Joystick controlled filters & faders • plus MUCH MUCH MORE

WRITE NOW
Free information... send self addressed, stamped envelope to
C F R ASSOCIATES
P.O. Box F Newton, N.H. 03858
"the oldest name in synthesis for the experimenter"

PASS FCC examinations! New questions-answers guide for first, second, third licenses. Guaranteed. \$6.95 postpaid. **EGW PUBLICATIONS**, Box 5516-FI, Walnut Creek, CA 94596

ELECTRONICS DESIGN NEWSLETTER

- ★ Logic Design Techniques
- ★ Digital & Linear Design Theory & Procedures
- ★ Construction Projects

Subscription \$6 Sample Copy \$1
VALLEY WEST Box 2119-L Sunnyvale, CA 94087

TELEPHONE bugged? Don't be Watergated! Countermeasures brochure \$1.00. **NEGEYE LABORATORIES**, Box 547-RE, Pennsboro, WV 26415

FREE educational electronics catalog. Home study courses. Write to: **EDUKITS WORKSHOP**, Dept. 283G, Hewlett, NY 11557

F.C.C. EXAM MANUAL

PASS FCC EXAMS! Memorize, study—Test! Answers for FCC 1st and 2nd class Radiotelephone licenses. Newly revised multiple choice questions and diagrams cover all areas tested in FCC exams, plus Self-Study Ability Test. \$9.95 postpaid. Money-back guarantee.

COMMAND PRODUCTIONS P.O. Box 26348 E
RADIO ENGINEERING DIV. SAN FRANCISCO, CAL 94126

FOR SALE

RECEIVERS, components, test equipment. Illustrated catalog 25¢. **E. FRENCH**, P.O. Box 249, Aurora, IL 60507

TV games kits P/C boards

Send for your information packet today— which also includes circuit functions, component line up and accessories. Information Packet \$1.00 (refundable with order).

visulex P.O. Box 4204R Mountain View, CA 94040

NEW adjustable three output regulated power supply, plus 900 parts worth \$400.00 list. Solid state cartrivision television recorder electronic unit. Schematics, parts cross reference. Heath-kit television transistor substitutions. Power CB radios, microprocessors. \$17.95 plus \$3.50 S&H, USA. Free brochure. Master Charge, BankAmericard. Satisfaction guaranteed. **MADISON ELECTRONICS COMPANY, INCORPORATED**, Box 369, D101, Madison, AL 35758

PICTURE TUBE MACHINE
We buy and sell NEW and USED CRT rebuilding machinery. COMPLETE TRAINING. Buy with CONFIDENCE from the ORIGINAL MFG. For complete details send name, address, zip code to **LAKESIDE INDUSTRIES**, 3520 W. Fullerton Ave., Chicago, Ill. 60647. Phone: 312-342-3399

IN-circuit transistor tester. Tone indicates good transistor. Plans \$2.00. **ZACH SCIENTIFIC**, 39 Bayberry Lane, Levittown, NY 11756

SAVE ELECTRIC POWER!
Save up to 80% electrical power with this unique, inexpensive, portable, permanent and legal method applicable for shops, homes, factories, businesses, farms, sites. 100% Refund Guaranteed if not scientifically sound or if it employs gimmicks.

CONSUMERTRONICS CO.
Information \$1.00
P.O. Box 542 Alamogordo, N.M. 88310

COMPLETE ALARM CLOCK

- * 4 Digits 0.5" LED with brightness control
- * 12 Hour display with AM/PM indication
- * True 24 hour alarm with repeatable snooze
- * Power failure indication for power interrupt



MODEL EC 400
(Not A Kit)
Only \$22.50

NEW CLOCK KITS!



MODEL OC1032
JUMBO DIGITS
ALARM CLOCK
1.2" Bright Yellow
Color Readouts

Features: 12/24 Hour Display, 24 Hour Alarm Set, 10 Min Snooze Switch, AM/PM Indicator
Kit Includes: Woodlike Color Plastic Case, 4 Digit 1.2" Neon Display with AM/PM, TMS 3834 Alarm Chip, 2 pcs. double sided PC Boards, 16 transistors, all other components, Transformer and speaker

SPECIAL \$35.90



MODEL OC1030
4 DIGIT
ALARM CLOCK KIT
0.5" Green Color
Readouts

Features: 12/24 Hour Displays, 24 Hour Alarm Set, 10 Min Snooze Switch, AM/PM Display.
Kit Includes: Orange Color Plastic Case, 0.5" LD8132 Green Color Readouts PC boards with transformer, all electronic parts with speaker.

Only \$28.50

THE MOST POPULAR



MM5314 KIT

WITH A NEW CASE!!

Features: 12/24 Hour Display
50/60 HZ Input 6 Digits Readout
Kit Includes: Grey Color Plastic Case
MM5314 Clock Chip PC Boards and Trans-
former, 6 Green Color 0.3" Tube Readouts,
All other transistor Drivers and other Com-
ponents.

Special Only \$19.95 ea.



MODEL CT7001

Drive 6
Fairchild FND
0.5" Red LED
with MONTH & DATE
50/60HZ and ALARM

(without case) **Only \$28.50 ea.**

COMPUTER KEYBOARDS



Standard Teletype Keyboards with gold plated contact switches. All switches are independent and allow you to connect into any form of output.

Only \$22.50

MODEL B SPECIAL ONLY \$16.50 ea.

Fully ASCII decoded with electronic parts TTL logic. Used but all in good condition.

CLOCK CHIPS

MM 5311	24 pin	6 digits	
MUX and BCD output		\$4.50 each	
MM 5313	28 pin	6 digit	
MUX output		\$4.00 each	
MM 5314	24 pin	6 digits	
MUX output		\$3.50 each	
CT 7001	28 pin		\$6.50 each
Alarm Time & Date			
MM 5316 (F3817)	40 pin		\$4.50 each
Alarm, Direct Drive Led			

GOLD WIRE WRAP IC SOCKETS

14 pin	.36 each	10 for \$3.00
16 pin	.50 each	10 for 4.00
24 pin	1.25 each	10 for 10.00
28 pin	1.25 each	10 for 10.00

SOLDER TAIL SOCKETS

14 pin	.35 each	10 for 2.80
16 pin	.36 each	10 for 3.00
18 pin	.40 each	10 for 3.50
24 pin	1.00 each	10 for 8.00
28 pin	1.10 each	10 for 9.00
40 pin	1.25	10 for 10.00
Standard Xtal Socket	.35 each	



12 VDC Relay
SPDT 4 amp
\$1.25 ea.



6V 6AMPH YUASA
Wet Rechargeable Battery
\$7.50 ea.
**Add 50c Postage for This Item

AC ADAPTERS

110V AC Input
4.5V 100MA, 6V 100MA
9V 100MA, 12V 100MA
\$2.85 each
12V 150MA AC output
\$2.00 ea.

TRANSFORMERS

110V input
12 0-12V 1amp \$2.25 ea.
12V CT 500MA
with one group 165V \$1.50 ea.
0.3-12-24V 500MA \$2.75 ea.

NI-CD FAST CHARGE BATTERIES

Rechargeable AA Size
BY SANYO
ALL BRAND NEW
\$1.60 each 4 for \$6.00

AUTO ALARM KIT

The Cimefighter Auto Alarm is an electronic, self-controlled auto protection system, normally mounted within the glove box of an automobile. Two minutes after turning off the ignition, the alarm automatically turns itself "on". When the auto is re-entered, the horn will sound after a 10-45 second entry delay. The automobile owner, by inserting the ignition key, will activate the alarm. Once activated, the alarm will sound for two minutes before automatically turning off. The alarm then resets and is ready to again protect the vehicle from unwanted entry.

FEATURES: Simple installation 5 wires. Automatically turns on when auto is parked. Adjustable entry time. Extended exit time to allow for untrashed exit from vehicle. Numerous applications include protection of boats, campers, trailers, motorcycles, trucks. Cannot be deactivated by "hot wiring" an auto. Cannot be turned off without ignition key. Neg. active ground only.
ONLY \$10.00 per kit Completed Unit \$16.00

LED READOUTS



Fairchild FSC 800
0.8" Red LED 3 1/2 Digits
with AM/PM
Direct Drive by MM 5316 or Fairchild 3817
\$10.50 ea.



JUMBO LED

Fairchild FND 800
0.8" Common Cathode
Red Color
ONLY \$3.50 ea.



MAN 74	Red	\$1.00
MAN 84	Yellow	\$1.50
HP 0.3"	Red	\$1.20
DL 747	RZ D	\$2.50
DL 729	Double Digit	\$2.50
DL 707	0.3" Red	\$1.30
FND 70	0.25" Red	\$0.60
FND 503	0.5" Red	\$1.60
FLV-50	Submini Red	\$0.15 ea.
FLV-209	Mini Red	\$0.15 ea.
	Jumbo Red	\$0.15 ea.
	Jumbo Green	\$0.25 ea.
	Jumbo Orange	\$0.25 ea.

50 U.A. PANEL METER



First design for metal
Finder Scaled from 0-10
but can be erased and your
own scale put on too. Brand
new in box. **Only \$3.80 ea.**

MEMORIES

1702A Erasable Prom \$13.50 ea.
2102-1 1024 Bit Static RAM \$2.25 ea.
Over 10 pcs. \$1.99 ea.

LOOK

2107A 4K RAM
in 22 pin DIP
4096 BIT Dynamic Memory, Intel
Prime Units
\$16.50 each or 4 for \$60.00
TTL AND CMOS PRICE LIST WILL BE
MAILED OUT ON REQUEST.



COMPUTER GRADE CAPACITOR

15500 MFD
75 V DC
\$4.95 ea.
5600 MFD
60V DC
\$1.25 ea.

ELECTRONIC SWITCH KIT

CONDENSER TYPE

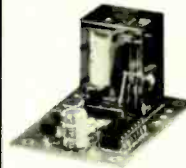

Touch on Touch Off
use 7473 I.C.
and 6V relay
\$5.50 each



FM WIRELESS MIC KIT

Transmit range up to 500ft.

Easy to assemble
\$4.50 each

Sub-Mini Size
Condenser Microphone
\$2.50 each



ELECTRONIC ORGAN



KEYBOARD

3 Octaves Full Size
Limited Quantity
\$33.00 each

SAE DIP SWITCHES



Part No 1004 692 4X5PST SW
1008 692 8X5PST SW

4 Toggle SPST Switches on a Mini DIP
(8 pins) Only \$1.50 ea
8 Toggle SPST Switches on a DIP
(16 pins) Only \$2.60 ea

SUBMINIATURES TOGGLE SWITCHES



SPDT On-None-Off \$1.30 ea
DPDT On-None-Off \$1.50 ea

ECCO BCD THUMBWHEEL SWITCHES



8 positions \$1.25 ea
10 positions \$2.15 ea
12 positions \$2.50 ea

QUARTZ CRYSTALS



1MHz Computer Crystals \$4.25 ea.
3.58 MHz Color TV
Crystals \$1.25 ea
Use with Nation MM 5369 to make
a perfect time base for clock.



NEW!
NATIONAL MM 5369 17
STAGE PROGRAMMABLE
OSC/DIVIDER generate A
60 Hz reference Frequency
with a 3.58 MHz Color TV
XTAL in Mini DIP Package
ONLY \$2.25 each

NEW ALARM CLOCK CHIPS

MM 5375 Series by National 24 pin package
Multiple output with brightness control
ONLY \$3.50 ea. Data 25 ea.

FEATURE	PROGRAMMABLE OPTIONS					PART #
	AA	AB	AC	AD	AE	
Input Frequency	50 HZ					
Time Display	12 Hour					
Duplicate Register	Alarm Counter					
Alarm Signal	Date Counter					
Alarm Output	Minuse Timer					
Alarm of Power Failure	Snooze Timer					
Segment Output Patterns	Time					
AMB or PHL Indication	OC Level					
	Modulated @ 2 BHz					
	Not Modulated					
	ON					
	OFF					
	Vis for Display					
	Vdd for Display					
	Display at all times					

MINIMUM ORDER \$10.00. California residents add 6% sales and 1.50 to cover postage and handling. Out-of-state and overseas countries add \$2.50.

SEND CHECK OR MONEY ORDER TO:



FORMULA INTERNATIONAL INC.

12603 CRENSHAW BOULEVARD • HAWTHORNE, CALIFORNIA 90250

For more information please call (213) 679-5162

STORE HOURS 10-7 Monday - Saturday

9/76

CLOCKS

6 digit AUTOMOTIVE CLOCK KIT complete with a CRYSTAL TIMEBASE accurate to .01 percent. 12 volts d.c. operation - built in noise suppression and voltage spike protection. Read-outs blank when ignition is off - draws 25 mA in standby mode. Has .3 in. readouts. Use it in your car or for all applications where a battery-operated clock is needed. Approximate size 3" x 3.5" x 1.75"

WITH BLACK PLASTIC CASE \$34.95 ppd.
WITHOUT CASE \$29.95 ppd.
ASSEMBLED AND TESTED \$45.95 ppd.

MM 5320 TV CAMERA SYNC GENERATOR - this LSI chip supplies the basic sync functions for either color or monochrome 525 line/60 Hz. camera and video applications. The price is \$4.95 ppd. and includes the data sheet.

CMOS CRYSTAL TIMEBASE KITS with .01 percent accuracy. 5-15 v.d.c. operation. Draws only 3 mA at 12 volts. Single I.C. - very small size - the P.C. board is 7/8" x 1-5/8". Choose a main output of 50 or 100 Hz., 60 Hz., 500 or 1000 Hz., or 1 Hz. Several related frequencies are also available on each board, in addition to the main ones listed above. Be sure to specify the Frequency you want. All kits are \$10.95 ppd.

Flyer available - write for it or circle the reader service card.

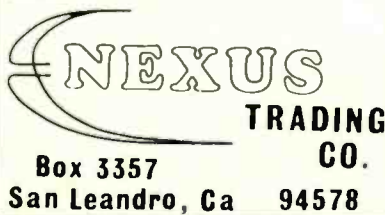

NEXUS TRADING CO.
Box 3357
San Leandro, Ca 94578

Circle 19 on reader service card



CLOCK KIT \$14.00

Includes all parts with MM5316 chip, transformer, drilled & etched PC board, all except case. #SP-284 \$14 or 2/\$25

ASCII KEYBOARD, brand new w/paperwork \$45.00

AA NICAD CELLS brand new \$1.25 each 9/\$9.00

C-MOS LINEAR all brand new RCA

301	\$.60	747	\$.82	CLOCK CHIPS
307	\$.52	748	\$.50	MM5314
324	1.80	1458	.96	MM5316
339A	1.60	3401	.80	7001
741	.50	555	.60	

POWER SUPPLY KIT

Puts out 24-12-6 volt DC 2 amps. Includes xfmr, line cord, filter, silicon bridge. #PK-2B \$9.00

B & L HELIUM NEON GAS LASER

Fully assembled, runs on 115 volts AC. Less Laser tube. \$15.00

POWER AMP TRANSFORMER \$9.00

115 volts input, output of 96 VCT 2 amps. \$9.00 each 3/\$25

Please add shipping cost on above. FREE catalog

Meshna SURPLUS ELECTRONIC MATERIAL
P.O. Box 62
19 ALLERTON STREET
E. LYNN MASS. 01904

Circle 66 on reader service card

PARTS! CORNELL TUBES!
Send For FREE CORNELL'S New Color Catalog 43 Pgs. New Items
33¢ per tube ORDER FREE IF NOT SHIPPED IN 24 HOURS
36¢ per tube
4215 E UNIVERSITY AVE SAN DIEGO CALIF 92105

FREE Catalog. Strobe lights, UART's, memories, digital thermometers, rechargeable batteries, LED's, transistors, IC's unique components. CHANEY'S, Box 27038, Denver, CO 80227

AMAZING ELECTRONIC PROJECTS and PRODUCTS:

Lasers Super Powered, Burning, Cutting, Rifle, Pistol, Pocket. See in Dark—Shotgun Directional Mike—Unscramblers—Giant Tesla—Stunwand—TV Disrupter—Energy Producing, Surveillance, Detection, Electrifying, Ultrasonic, CB, Auto and Mech. Devices, Hundreds More—All New Plus INFO UNLTD PARTS SERVICE. Catalog \$1. Information Unlimited, Box 626, Lord Jeffrey Court, Amherst, N.H. 03031.

QUALITY ELECTRONIC COMPONENTS
NEW DISCOUNT SCHEDULE SAVES YOU EVEN MORE!
AMD 8080A \$34.95 2102-1 \$1.99
MICROPROCESSOR 1024 Bit Random Access Memory
0-70°C 480 ns Clock Period 500 ns Max Access Time
INTEGRATED CIRCUITS - TTL, CMOS, LINEAR & MOS

7400 .21	7473 .30	74174 .98	4001 .23	4073 .23
7401 .21	7474 .30	74175 .93	4002 .23	4075 .23
7402 .21	7475 .49	74176 .79	4006 1.22	4081 .23
7403 .21	7476 .32	74177 .79	4007 .23	4082 .23
7404 .21	7480 .70	74180 .70	4008 .79	4502 .79
7405 .21	7482 .70	74181 2.15	4009 .44	4510 1.14
7406 .25	7483 .70	74187 .79	4010 .44	4511 1.05
7407 .25	7485 .89	74184 2.19	4011 .23	4514 2.80
7408 .21	7486 .29	74185 2.19	4012 .23	4515 2.80
7409 .21	7489 2.19	74188 3.50	4013 .40	4516 1.23
7410 .21	7490 .44	74189 3.50	4014 .96	4518 1.14
7411 .21	7491 .70	74190 1.23	4015 .96	4520 1.14
7412 .21	7492 .44	74191 1.23	4016 .40	4527 1.68
7413 .25	7493 .44	74192 .98	4017 .05	4528 1.88
7414 .89	7494 .70	74193 .88	4018 1.05	4585 1.23
7416 .25	7495 .70	74194 .88	4019 .23	LM309K 1.90
7417 .25	7496 .70	74195 .88	4020 1.14	LM324N 1.26
7418 .21	74100 1.28	74196 .88	4021 1.28	LM340T-5 1.25
7419 .25	74107 .30	74197 .88	4022 .96	LM340T-4 1.25
7423 .35	74109 .33	74198 1.49	4023 .23	LM340T-8 1.25
7425 .33	74121 .33	74199 1.49	4024 .84	LM340T-12 1.25
7426 .25	74122 .44	74201 1.09	4025 .23	LM340T-15 1.25
7427 .33	74123 .61	74279 .58	4026 1.68	LM340T-18 1.25
7428 .26	74125 .40	74365 .67	4027 .40	LM340T-24 1.25
7430 .21	74126 .40	74366 .67	4028 .69	LM3900N .86
7432 .25	74129 .70	74367 .67	4029 1.14	MS361T 3.24
7433 .30	74141 .88	74368 .67	4030 .23	MS40L 2.04
7437 .25	74145 .70	75150 1.31	4033 1.51	MS55V .46
7438 .25	74147 1.63	75450 .86	4034 3.50	MS56A .86
7440 .21	74148 1.30	75451 .61	4035 1.14	MS608 .38
7441 .88	74150 1.16	75452 .61	4040 1.14	MS618 3.83
7442 .53	74151 .70	75453 .61	4041 .79	MS628 3.83
7443 .63	74153 1.65	75454 .61	4042 .79	MS658 1.25
7444 .63	74154 1.03	75491 .81	4043 .70	MS66V 1.28
7445 .70	74155 .70	75492 .84	4044 .70	MS67V 1.36
7446 .70	74156 .70	75493 1.09	4046 1.86	MS700TC .44
7447 .70	74157 .70	75494 1.19	4049 .40	UA710CA .44
7448 .70	74160 .88	8093 .40	4050 .40	UA711CA .53
7450 .21	74161 .88	8094 .40	4051 1.26	UA723CA .60
7453 .21	74162 .88	8095 .67	4052 .26	UA741CV .44
7454 .21	74163 .88	8096 .67	4053 .72	UA747CA .70
7460 .21	74164 .96	8097 .67	4060 1.58	UA748CV .49
7470 .30	74166 1.26	8098 .67	4066 .79	UA1458V .53
7472 .30	74170 2.64	82525 2.19	4071 .23	2102-1 1.99
	74173 1.42	4000 .23	4072 .23	8080A 34.95

BISHOP GRAPHICS Printed Circuit Drafting

Aids are now available from Digi-Key

DATA BOOKS

TTL IC's - 592 pages \$4.00	INTERFACE IC's - 464 pages \$4.00
LINEAR IC's - 704 pages . . . \$4.00	VOLTAGE REGULATORS - 128 pages \$3.00
CMOS IC's - 256 pages \$3.00	LINEAR APPLICATIONS - 432 pages \$4.00
TRANSISTORS - 288 pages . . \$3.00	
MEMORY IC's - 592 pages . \$3.00	

SILICON TRANSISTORS

MP5918, MP5930, MP5222A, MP5236A, MP52712, MP52907A, MP53392, MP53393, MP53394, MP53395, MP53563, MP53565, MP53638, MP53639, MP53640, MP53641, MP53643, MP53645, MP53646, 2N3904, 2N3906, 2N4124, 2N4126, 2N4401, 2N4403, 2N4410, 2N4488, 2N5087, 2N5089, 2N5129, 2N5133, 2N5134, 2N5137, 2N5138, 2N5139, 2N5210, 2N5964 .16, .15, .5V/10, .5V, 60/100 of some part no.
MPF102 .36 \$30.60/C 2N5457 .48 \$41.00/C MP5A13 .26 \$24.00/C 2N3055 .99 \$85.00/C

AP SUPER STRIP II—Universal Breadboarding

Element with 840 Solderless Plug-In Tie-Points
\$17.00

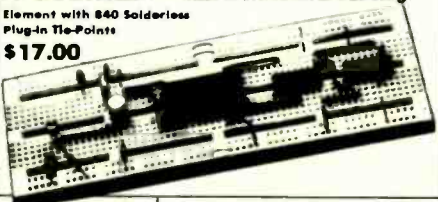

LED DISPLAYS

FDN357 C.C. 375" . \$1.75	FDN500 C.C. 500" . \$1.75	FDN507 C.C. 500" . \$1.75	FDN800 C.C. 800" . \$3.50	FDN807 C.C. 800" . \$3.50
---------------------------	---------------------------	---------------------------	---------------------------	---------------------------

LED LAMPS

NSL5053 1-1/4"18c	NSL5056 1-1/4"18c
-----------------------------	-----------------------------

1/2 WATT ZENER DIODES

1N5228B 3.3v .15 \$11/C	1N5228C 3.6v .15 \$11/C	1N5228D 3.9v .15 \$11/C	1N5228E 4.3v .15 \$11/C	1N5228F 4.7v .15 \$11/C	1N5228G 5.1v .15 \$11/C	1N5228H 5.6v .15 \$11/C	1N5228J 6.0v .15 \$11/C	1N5228K 6.2v .15 \$11/C	1N5228L 6.8v .15 \$11/C	1N5228M 7.5v .15 \$11/C	1N5228N 8.2v .15 \$11/C	1N5228P 9.1v .15 \$11/C	1N5228Q 10v .15 \$11/C	1N5228R 11v .15 \$11/C	1N5228S 12v .15 \$11/C	1N5228T 15v .15 \$11/C	1N5228U 18v .15 \$11/C
-------------------------	-------------------------	-------------------------	-------------------------	-------------------------	-------------------------	-------------------------	-------------------------	-------------------------	-------------------------	-------------------------	-------------------------	-------------------------	------------------------	------------------------	------------------------	------------------------	------------------------

RECONDITIONED test equipment. \$0.50 for catalog. WALTER'S TEST EQUIPMENT, 2697 Nickel, San Pablo, CA 94806

econotrace — \$39.50
CONVERT YOUR SCOPE TO A CALIBRATED SEMI-CONDUCTOR CURVE TRACER FOR THE LOWEST COST EVER. MEASURE GAIN, LEAKAGE, OSCILLOSCOPE MATCH PARS, ETC. ALL CMOS. BATTERY INCLUDED. EASY TO OPERATE. MONEY BACK GUARANTEE. SEND CHECK FOR \$39.50 PLUS \$2.00 FOR POSTAGE, INS. & HANDLING. COLO. RES. ADD 3 1/2% SALES TAX.
Imb Science
PO BOX 1972 BOULDER, COLO. 80302



COLOR video tape recorder \$250.00. T.V. camera \$150.00, videotapes \$5.00. Cartrivision manuals spare parts and bulk videotape. Send stamp to: DENNIS TRIMBLE, 5835 Herma St., San Jose, CA 95123, 408-227-6330

LOW cost digital/analog test equipment. Exceptional values. Free catalog. SALEN ELECTRONICS, P.O. Box 82, Skokie, IL 60076

SPECIAL PURCHASE
NATIONAL MA1001A DIGITAL ALARM CLOCK MODULE
with Transformer and Switches
\$12.95!

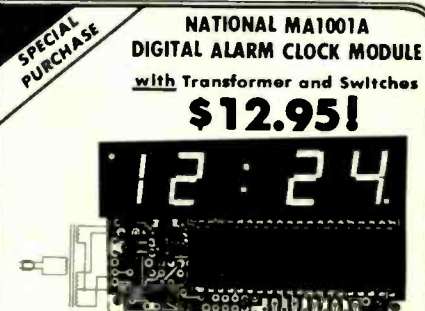

MA1001A \$9.50 when purchased without transformer & switches

FEATURES:

- Bright 4 Digit 0.5" LED Display
- Assembled & Tested Module
- 12 Hour Format with PM Indicator
- 50 or 60 Hz Operation
- Power Failure Indication
- Brightness Control Capability
- Alarm and Snooze Timers
- Compact 3.0"x1.75"

A Great Bargain, but Quantities are limited — So Order Now!

TRIACT TO220 PACKAGE TO AMP/400 VOLT 50c

4.8v Coil \$1.70	\$125/C
6.0v Coil \$1.70	\$125/C
12v Coil \$1.70	\$125/C
24v Coil \$1.70	\$125/C

TRANSFORMER Pri 120 V. Sec 12V 300 Ma. \$1.00

REED RELAYS

1.5 Amp SPST N.O. Contacts

4.8v Coil \$1.70	\$125/C
6.0v Coil \$1.70	\$125/C
12v Coil \$1.70	\$125/C
24v Coil \$1.70	\$125/C

1/4 WATT 5% CARBON FILM RESISTORS

So much in multiples of 5 per vol. \$1.70/100 of same value. 10 ohm to 1.0 meg

I.C. SOCKETS

8 Pin Solder Tab	.17
14 Pin Solder Tab	.20
16 Pin Solder Tab	.22
18 Pin Solder Tab	.29
24 Pin Solder Tab	.38
28 Pin Solder Tab	.45
40 Pin Solder Tab	.63
8 Pin Wire-Wrap	.24
14 Pin Wire-Wrap	.26
16 Pin Wire-Wrap	.30
18 Pin Wire-Wrap	.60
24 Pin Wire-Wrap	.86
28 Pin Wire-Wrap	1.23
40 Pin Wire-Wrap	1.00

WIRE WRAPPING WIRE

Pre-cut and stripped Ename insulated wire from 1.8" to 15.0" in rod or black. Also sold in bulk lengths.

RESISTOR ASSORTMENTS

5 sec. all 10% 1/4 W. Val. from 2.2 to 22 meg (425 pgs) \$12.80

5 sec. all 10% 1/4 W. Val. from 10 to 5.6 meg (1200 pgs) \$12.80

VOLUME DISCOUNT SCHEDULE

Quantity	Discount	Total	Amount
1-500	0%	NET	1 100.00-999.99 LESS 15%
501-1000	5%	NET	1 500.00-999.99 LESS 20%
1001-2500	10%	NET	1 1000.00 & up LESS 25%
— Then Add the Standard Charge Below			
STANDARD SHIPPING/HANDLING CHARGE			
If your merchandise total other discount is between:			
1 \$ 0.00-4.99	add \$2.00	1 \$ 50.00-999.99	add \$2.25
1 \$ 50.00-249.99	add \$0.75	1 \$ 1000.00 & up	No Charge
1 \$ 250.00-999.99	add \$0.50		
COD orders accepted & insurance to USA & Canada			
CDD ORDERS ACCEPTED FOR SAME DAY SHIPMENT! — CALL 218-681-6674			

DIGI-KEY CORPORATION
P.O. Box 677 Thief River Falls, MN 56701

Circle 97 on reader service card

EVERYTHING REDUCED LOWEST EVER IC PRICES

TTL					
7400	.13	7451	.17	74153	.89
7401	.16	7452	.17	74154	1.20
7402	.15	7454	.17	74155	.97
7403	.15	7460		74156	.97
7404	.16	7464	.35	74157	.99
7405	.19	7465	.35	74158	1.79
7406	.20	7470	.30	74160	1.23
7407	.28	7472	.30	74161	.97
7408	.18	7473	.35	74162	1.39
7409	.19	7474	.28	74163	1.09
7410	.16	7475	.49	74164	.99
7411	.25	7476	.30	74165	.99
7413	.43	7483	.68	74166	1.25
7414	.65	7485	.88	74170	2.10
7416	.35	7486	.40	74173	1.49
7417	.35	7489	2.25	74174	1.23
7420	.16	7490	.43	74175	.97
7422	.30	7491	.75	74176	.89
7423	.29	7492	.48	74177	.84
7425	.27	7493	.48	74180	.90
7426	.26	7494	.78	74181	2.45
7427	.29	7495	.79	74182	.79
7430	.20	7496	.79	74184	1.90
7432	.23	74100	.98	74185	2.20
7437	.25	74105	.44	74187	5.75
7438	.25	74107	.37	74190	1.15
7440	.15	74121	.38	74191	1.25
7441	.89	74122	.38	74192	.95
7442	.59	74123	.65	74193	.85
7443	.73	74125	.54	74194	1.25
7444	.73	74126	.58	74195	.74
7445	.73	74132	.89	74196	1.25
7446	.81	74141	1.04	74197	.73
7447	.79	74145	1.04	74198	1.73
7448	.79	74150	.97	74199	1.69
7450	.17	74151	.79	74200	5.45

LOW POWER					
74100	.29	74151	.29	74190	1.40
74102	.29	74155	.29	74191	1.20
74103	.23	74171	.29	74193	1.50
74104	.29	74172	.45	74195	1.50
74106	.29	74173	.56	74198	2.25
74110	.29	74174	.56	74164	2.25
74120	.29	74178	.75	74165	2.30
74130	.29	74185	1.09		
74142	1.39	74186	.65		

LOW POWER SCHOTTKY					
741500	.36	741532	.38	741595	2.09
741502	.36	741540	.45	7415107	.59
741504	.36	741542	1.40	7415164	2.20
741508	.36	741574	.59	7415193	2.20
741510	.36	741590	1.30	7415197	2.20
741520	.36	741593	1.30		

HIGH SPEED					
74100	.25	74122	.25	74161	.25
74101	.25	74130	.25	74162	.25
74104	.25	74140	.25	74174	.39
74108	.25	74150	.25	741101	.58
74110	.25	74152	.25	741102	.58
74111	.25	74153	.25	741103	.58
74120	.25	74155	.25	741106	.72
74121	.25	74160	.25	741108	.72

SCHOTTKY					
74500	.38	74508	.52	74522	.38
74502	.45	74510	.38	74532	.52
74503	.38	74520	.38	74574	.38
74504	.45				

8000 (NATIONAL)					
8091	.61	8220	1.49	8811	.65
8092	.61	8230	2.19	8812	1.02
8095	1.25	8288	1.49	8822	2.19
8121	.80	8520	1.16	8830	2.19
8123	1.43	8552	2.19	8831	2.19
8200	2.33	8563	.62	8836	.29
8214	1.49	8810	.70	8880	1.19

8000 (SIGNETICS)					
8263	5.79	8267	2.59		

9000					
9002	.40	9309	.79	9601	.61
9301	1.03	9312	.79	9602	.79

DTL					
930	.15	937	.15	949	.15
932	.15	944	.15	962	.15
936	.15	946	.15	963	.15

POCKET CALCULATOR KIT

5 function plus constant — addressable memories with individual recall — 8 digit display plus overflow — battery saver — uses standard or rechargeable batteries — all necessary parts on ready to assemble form — instructions included



Calc. kit. & Adapter \$9.95
Batteries (alkaline, disp.) 2.00

Data included with order on request. Add \$.30 ea. if item is priced below \$1.00

IC SOCKETS					
Solder Tail - low profile					
8 pin	\$.17	24 pin		.42	
14 pin	.20	28 pin		.59	
16 pin	.22	40 pin		.69	
18 pin	.29				
WIRE WRAP - gold plate					
14 pin	.49				

CMOS					
4000A	.26	4018A	1.39	4066A	.89
4001A	.25	4020A	1.72	4068A	.44
4002A	.25	4021A	1.18	4069A	.44
4006A	1.35	4022A	.94	4071A	.26
4007A	.26	4023A	.25	4072A	.35
4008A	1.52	4024A	.89	4073A	.39
4009A	.57	4025A	.25	4075A	.39
4010A	.54	4027A	.59	4078A	.39
4011A	.29	4028A	.98	4082A	.35
4012A	.25	4030A	.44	4518A	1.56
4013A	.45	4035A	1.27	4528A	1.56
4014A	1.27	4040A	1.39	4585A	2.10
4015A	1.27	4042A	1.47		
4016A	.48	4049A	.59		
4017A	1.01	4050A	.59		

74C00	.19	74C74	1.04	74C162	2.49
74C02	.26	74C76	1.34	74C163	2.66
74C04	.44	74C107	1.13	74C164	2.66
74C08	.68	74C151	2.62	74C173	2.22
74C10	.35	74C154	3.15	74C195	2.26
74C20	.35	74C157	1.76	80C95	1.15
74C42	1.61	74C160	2.48	80C97	.96
74C73	1.04	74C161	2.49		

THESE DISCOUNTS APPLY TO TOTAL OF ORDER — SPECIALS INCLUDED

10% OFF ON ORDERS OVER \$25
15% OFF ON ORDERS OVER \$100

LARGE QUANTITY PRICING AVAILABLE ON REQUEST
PLEASE SPECIFY ITEM AND QUANTITY

MEMORIES					
1101	256 bit RAM MOS 16 pin		1.39		
1103	1024 bit RAM MOS dynamic 18 pin		10.95		
1702A	2048 bit PROM static electrically programmable UV erasable 24 pin		1.95		
2102	1024 bit RAM static 16 pin		1.95		
5203	2048 bit PROM static electrically programmable UV erasable 24 pin		10.95		
5260	1024 bit RAM MOS dynamic 16 pin		1.95		
5261	1024 bit RAM MOS dynamic 16 pin		1.95		
7489	64 bit ROM TTL 16 pin		2.25		
82523	256 PROM-SCHOTTKY 16 pin		3.69		
F93410	256 bit RAM bi-polar 16 pin		1.95		
74187	1024 bit ROM TTL 16 pin		5.75		
74200	256 bit RAM tri-state 16 pin		5.45		

CLOCK CHIPS					
MMS5311	6 digit multiplexed BCD, 7 seg, 12-24 Hr, 50-60 Hz — 28 pin		4.45		
MMS5312	4 digit multiplexed BCD, 7 seg, 1pps, 12-24 Hr, 50-60 Hz — 24 pin		3.95		
MMS5314	6 digit multiplexed 12-24 Hr, 50-60 Hz 24 pin		4.45		
MMS5316	4 digit, 12-24 Hr, 50-60 Hz, alarm 40 pin		4.95		
537AA	4-6 digit, 12 hour, 60 Hz snooze alarm brightness control capability, alarm tone output — 28 pin		4.95		
CT7001	6 digit, 12-24 Hr, 50-60 Hz, alarm, timer and date circuits — 28 pin		5.95		

CALCULATOR CHIPS					
CT5002	12 digit, 4 function fixed decimal battery operation — 40 pin		1.95		
CT5005	12 digit, 4 function plus memory, fixed decimal — 20 pin		2.49		
MMS5725	8 digit, 1 function, floating decimal 18 pin		1.98		
MMS5736	6 digit, 4 function, 9V battery operation — 18 pin		2.95		
MMS5738	8 digit, 5 function plus memory and constant floating decimal, 9V battery operation — 24 pin		3.95		
MMS5739	9 digit, 4 function, 9V battery operation — 22 pin		3.95		

SHIFT REGISTERS					
MM5013	1024 bit accum. dyn. 8 pin		1.75		
MM5016	500/512 bit dyn. 8 pin		1.59		
5LS-4025	Quad 25 bit 2504 1024 bit multiplexed dyn 8 pin		.99		

UNIVERSAL BREADBOARD
Silver plated copper circuit board 1.5" x 3" x 1.5" — 2 rows of 27 holes for DIP IC's — space for transistors, resistors & capacitors. Versatile and simple for breadboarding IC circuits. \$1.90 ea.

LINEAR SEPTEMBER SPECIALS TTL

301	\$.21	DISPLAYS	CALCULATOR	JUMBO LED	7432	\$.19	
311	.59	MAN1	1.39	Red	7437	.20	
309K	.89	NSN71L	1.19	Green	7438	.18	
340T+5v	.99	5002	1.19	Yellow	7446	.69	
340T+15v	.99	5005	1.29		7474	.22	
741	.21	MAN8	1.39	5738	1.95	7490	.39
3900	.33					74121	.29
9602	.59					74123	.49
75491	.59					74164	.85
1310	1.79					74165	.85
						74193	.73

2102
1K STATIC RAM
COMPUTER QUALITY \$1.69

FREE RESISTOR KIT WITH EVERY \$50 ORDER

180 carbon film resistors ± 5%, 1/4 or 1/2 watt. 15 each of 12 values. First quality resistors supplied in a durable clear styrene utility box with color code chart. Includes 15 each 100K, 220, 470, 1K, 1.5K, 3.3K, 4.7K, 6.8K, 10K, 33K, 100K, 1M.

SPECIAL DEVICES					
372	AF-IF Strip Detector DIP		2.93		
546	AM Radio Receiver Subsystem DIP		.75		
1310	FM Stereo Demodulator DIP		2.90		
1496	Balanced Modulator-Demodulator		2.48		
1800	Stereo multiplexer DIP		1.18		
ULN2208	FM Gain Block 34db (typ) mDIP		1.35		
ULN2299	FM Gain Block 48db (typ) mDIP		1.35		
2513	Character Generator 64x85 DIP-24		10.20		
3046	Transistor Array DIP-14		.73		

MEMORIES					
1101	256 bit RAM MOS 16 pin		1.39		
1103	1024 bit RAM MOS dynamic 18 pin		10.95		
1702A	2048 bit PROM static electrically programmable UV erasable 24 pin		1.95		
2102	1024 bit RAM static 16 pin		1.95		
5203	2048 bit PROM static electrically programmable UV erasable 24 pin		10.95		
5260	1024 bit RAM MOS dynamic 16 pin		1.95		
5261	1024 bit RAM MOS dynamic 16 pin		1.95		
7489	64 bit ROM TTL 16 pin		2.25		
82523	256 PROM-SCHOTTKY 16 pin		3.69		
F93410	256 bit RAM bi-polar 16 pin		1.95		
74187	1024 bit ROM TTL 16 pin		5.75		
74200	256 bit RAM tri-state 16 pin		5.45		

CLOCK KIT 6 DIGITS (NS71L)

MMS5314 CLOCK CIRCUIT
2 PC BOARDS (CLOCK & DISPLAY)
ALL TRANSISTORS, RESISTORS
CAPACITORS & 3 SWITCHES \$14.95

WALL TRANSFORMER \$2.95
WOODEN CASE (UNASSEMBLED) \$3.95
CLOCK KIT, TRANSFORMER & CASE \$20.95

DVM CHIP 4 1/2 DIGIT

MM 5330 — P channel device provides all logic for 4 1/2 digit volt meter. 16 pin DIP with data. 9.95

DISPLAYS					
MAN1	\$1.95	ME4	\$.29		
MAN2	1.95	MY50	.12		
MAN3A	.19	NSL100	.12		
MAN5	2.25	NSL101	.12		
MAN6	2.49	NSL102	.15		
MAN7	1.49	MY50Z0			
MAN8	2.25	RED	.15		
MAN66	2.25	GREEN	.15		
DL10A	2.19	AMBER	.15		
FND500	1.89	CLEAR	.		

S. D. SALES CO.

P. O. BOX 28810 DALLAS, TEXAS 75228

ALARM CLOCK KIT SIX DIGIT LED

Thousands of hobbyists have bought and built our original clock kit and were completely satisfied. But we have received many requests for an alarm clock kit with the same value and quality that you have come to expect from S.D. So, here it is!

THE KIT INCLUDES:

- 1 Mostek 50252 Alarm Clock Chip
- 6 Hewlett Packard .30 in. common cathode readouts.
- 15 NPN Driver Transistors
- 2 Switches for time set
- 2 Slide Switches for alarm set and enable
- 1 Filter Cap
- 4 IN4002 Rectifiers
- 1 IN914 Diode
- 1 .01 Disc Cap
- 15 Resistors
- 1 Speaker for alarm
- 1 LED lamp for PM indicator.

\$9.95

PCB - 3.00

XFMR - 1.50

60 Hz. Crystal Time Base

FOR DIGITAL CLOCKS

S. D. SALES EXCLUSIVE!

\$5.⁹⁵

KIT FEATURES:

- A. 60 Hz output with accuracy comparable to a digital watch.
- B. Directly interfaces with all MOS clock chips.
- C. Super low power consumption (1.5 Ma typ.)
- D. Uses latest MOS 17 stage divider IC.
- E. Eliminates forever the problem of AC line glitches.
- F. Perfect for cars, boats, campers, or even for portable clocks at ham field days.
- G. Small size, can be used in existing enclosures.

BUY TWO FOR \$10.00

Kit includes crystal, divider IC, P.C. Board plus all other necessary parts and specs.

MOS 4 DIGIT COUNTER IC

All in one 28 PIN DIP. 4 Decade counters, latches, MUX circuits, display decoders, etc. Features: 5VDC operation, 25 MW power consumption, BOTH 7 segment and BCD outputs. Perfect for DVM's, frequency meters, tach's, etc. Can be cascaded for more digits. #5002 - \$8.95.

8008-1 MICRO PROCESSOR

New Units. High speed 8008. Almost twice as fast as units sold by others. Still a very versatile and widely used MPU. No data book, only pinout data included at this price. \$12.50 LIMITED QTY.

1101 A RAM IC

256 X 1 BITS. Perfect for 8008 or small systems such as telephone dials that do not require a lot of memory. Special 59c. 8 FOR \$4.

C & K MINI TOGGLE SWITCH

#7103 SUB MINI SPDT Center OFF. Special - 99c.

TTL INTEGRATED CIRCUITS

7400 - 19c	7430 - 19c	7476 - 35c	74153 - 75c
7402 - 19c	7432 - 34c	7480 - 49c	74154 - 1.00
74L04 - 29c	7437 - 39c	7483 - 95c	74157 - 75c
74S04 - 44c	7438 - 39c	7485 - 95c	74161 - 95c
7404 - 19c	7440 - 19c	7486 - 45c	74164 - 1.10
7406 - 29c	7447 - 85c	7490 - 65c	74165 - 1.10
7408 - 19c	7448 - 85c	7492 - 75c	74174 - 95c
7410 - 19c	7451 - 19c	7495 - 75c	74181 - 2.50
7411 - 29c	7453 - 19c	7496 - 89c	74191 - 1.25
7413 - 50c	7473 - 39c	74121 - 38c	74192 - 1.25
7420 - 19c	7474 - 35c	74123 - 65c	74193 - 1.00
	7475 - 69c	74141 - 75c	74195 - 69c



MOTOROLA POWER DARLINGTON - \$1.99
BACK IN STOCK!
Like MJ300T. NPN 80 V., 10A., HFE 6000 TYP. TO-3 case.
We include a free 723C volt. reg. with schematic for a power supply.
SPECIAL - \$1.99

MOTOROLA RTL IC'S

Brand new, factory prime. Hard to find, but still used in a variety of projects. (See the RTL Cookbook by Howard W. Sams.)

MC724P-59c	MC780P-89c	MC791P-69c
MC725P-59c	MC785P-49c	MC792P-59c
MC764P-49c	MC787P-89c	MC799P-59c
MC767P-69c	MC788P-49c	MC9704P-89c
MC771P-49c	MC789P-59c	MC9709P-69c
MC775P-89c	MC790P-89c	MC9760P-69c

MV-50 TYPE LED'S

by LITRONIX
10 for \$1
Factory Prime!

3 DIGIT LED ARRAY - 75c

by LITRONIX
DL33MMB. 3 MAN-3 Size Readouts in one package. These are factory prime, not retested rejects as sold by others. compare this price! 75c for \$2.



SALE ON CUT LEAD SEMICONDUCTORS

Leads were cut for PCB insertion. Still very useable.

1N914/1N4148	100/\$2
1N4002 1 Amp 100 PIV	40/\$1
1N4745A 16V 1W Zener	20/\$1
EN2222 NPN Transistor	25/\$1
EN2907 PNP Transistor	25/\$1
2N3904 NPN Driver Xstr.	25/\$1
2N3392 GE Pre-amp Xstr.	25/\$1
C103Y SCR. 800MA. 60V.	10/\$1

ALL NEW.
UNUSED.
SOME ARE
HOUSE #

SLIDE SWITCH ASSORTMENT

Our best seller. Includes miniature and standard sizes, single and multi-position units. All new, first quality, name brand switches. Try one package and you'll reorder more. Special - 12 for \$1 (Assortment)



DISC CAP ASSORTMENT

PC leads. At least 10 different values. Includes .001, .01, .05, plus other standard values.
60 FOR \$1



UPRIGHT ELECTROLYTIC CAPS

47 mfd 35 V-10/\$1 68 mfd 25V-8/\$1
Brand new by Sprague. PC leads.

RESISTOR ASSORTMENT

1/4 W 5% and 10%. PC leads.
A good mix of values. 200/\$2



1000 MFD FILTER CAPS

Rated 35 WVDC. Upright style with P.C. leads. Most popular value for hobbyists. Compare at up to \$1.19 each from franchise type electronic parts stores. S.D. Special 4 for \$1



FAIRCHILD BIG LED READOUTS

A big .50 inch easy to read character. Now available in either common anode or common cathode. Take your pick. Super low current drain, only 5 MA per segment typical.

FND - 510	Common Anode	YOUR CHOICE
FND - 503	Common Cathode	\$1.50 ea. 6 for \$7.50

DUAL 741C (5558) OP AMPS

Mini dip. New house numbered units by RAYTHEON.
4 FOR \$1

FET'S BY TEXAS INSTRUMENTS - SPECIAL 5 for \$1
#715-75 but with an internal house number. TO-92 plastic case. N. Channel, Junction type FET.

We do not sell junk. Money back guarantee on every item. No C.D.D. Texas Res. add 5% tax. Postage rates went up 30%! Please add 5% of your total order to help cover shipping.

S. D. SALES CO.

P.O. BOX 28810
DALLAS, TEXAS 75228

T - - K - - -
- - - - -

ORDERS UNDER \$10
ADD 75c HANDLING.

**ORDERS OVER \$15 CHOOSE
\$1 FREE MERCHANDISE**

FOREIGN ORDERS MUST BE PAID IN U.S. FUNDS

S. D. SALES CO.

P. O. BOX 28810
DALLAS, TEXAS 75228

UP YOUR COMPUTER!

21L02-1 1K LOW POWER
500NS STATIC RAM

TIME IS OF THE ESSENCE

And so is power. Not only are our RAM's faster than a speeding bullet but they are now very low power. We are pleased to offer prime, new 21L02-1 low power and super fast RAM's. Allows you to **STRETCH** your power supply farther and at the same time keep the **WAIT** light off.

8 for \$17.50

TOUCHTONE KEYBOARD SWITCH SET

By Controls Research. High quality long life switches with keytops. For encoders, combination locks, etc.

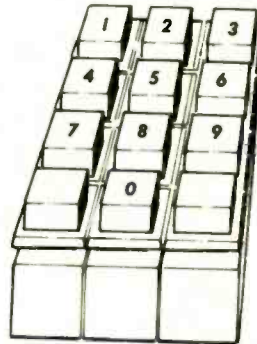

12 switches and tops, including 0 thru 9. Switch contacts are independent, allows hook-up to any matrix. Keytops easily removed.

\$2.95 Set
2 for \$5.00

4K LOW POWER RAM BOARD KIT

Imsai and Altair 8080 plug in compatible. Uses low power static 21L02-1 500 ns. RAM's. Fully buffered, drastically reduced power consumption, on board regulated, all sockets and parts included. Premium quality plated thru PC Board.

THE WHOLE WORKS

\$89.95

Call your **BANK AMERICARD** or **MASTER CHARGE**
order in on our
CONTINENTAL UNITED STATES TOLL FREE WATTS:

1-800-527-3460

TEXAS RESIDENTS CALL COLLECT:

214/271-0022

Please call between 8:30 AM and 6:00 PM C.S.T. — Monday through Friday. You may also call to check stock or just ask a question. However, only B.A.C. and M.C. orders will be accepted. We do not ship C.O.D. (See terms of sale on other page.)

*Exclusively
Yours*



1 MORE TIME

SEND FOR
**FREE CATALOG
WITH ALMOST
3000 ITEMS**

INCLUDING
B&K, EICO, RCA,
FLUKE, SENCORE,
SIMPSON, HICKOK
and LEADER

plus a complete line
of tubes, tools and
electronic supplies
at prices you won't
believe.

FORDHAM

RADIO SUPPLY CO., INC.
855A Conklin St., Farmingdale, N.Y. 11735
Tel: (516) 752-0050

Circle 63 on reader service card

THE **BIGGEST!**
COMPUTER STORE in the WORLD

- ★ NEW MICROCOMPUTER KITS
- ★ USED TERMINALS, PRINTERS
- ★ USED DISK, TAPE DRIVES
- ★ USED MINICOMPUTERS

AMERICAN USED
**COMPUTER
WAREHOUSE
STORE**

617-261-2701
584 Commonwealth Ave, BOSTON 02215
TUES, THUR-4:30 to 9:00; SAT, 9:30-5:30

MAGNETS. All types. Specials-20 disc, or 10 bar, or 2 stick, or 8 assorted magnets, \$1.00.
MAGNETS, Box 192-F, Randellstown, MD 21133

JAPANESE transistors. All transistors original factory made. Free catalog. **WEST PACIFIC ELECTRONICS,** P.O. Box 25837, W. Los Angeles, CA 90025

PRINTED CIRCUIT

Positive Acting Photo Resist; Carbide bits; Bubble etchers; Artwork; Epoxy Glass Boards.

Send stamp & address label for flyer
TRUMBULL
833 Balra Dr., El Cerrito, CA 94530

RADIO & TV tubes 36¢ each. One year guaranteed. Plus many unusual electronic bargains. Free catalog. **CORNELL,** 4217-E University, San Diego, CA 92105

NEW Canadian Magazine, "Electronics Workshop", \$5.00 yearly, sample \$1.00. **ETHCO,** Box 741 "A", Montreal

Etcetera, etcetera

COMPUTER SYSTEM

Multiprocessor design allows 8080/6800/FB/6502 & others to work together, share memory. 1K RAM. 1 Processor basic systems with ROM, Power, Cabinet, Display, TTY interfaces under \$500. Many options. **Electronic Tool Co.** 4736 W. El Segundo Blvd., Hawthorne, CA 90250

CANADIAN discount and factory clearouts catalog. Top brand stereo equipment, calculators, test gear, CB & communications, telephones. Factory dumps—government surplus. Amazing bargains. Unusual items. Rush \$1. **ETCO-RE,** 521 5th Ave., NYC, 10017

MANUALS for Govt. surplus radios, test sets, scopes, List 50¢ (coin). **BOOKS,** 7218 Roanne Drive, Washington, DC 20021

CARBON film resistors—1/4W, 5% 10—4.7 megohms for 3 1/2¢ each. Fifty per value \$0.85. Discounts available. Free samples/specifications. Other quality components. \$1.00 postage. **COMPONENTS CENTER,** Box 134R, New York, NY 10038

TELETYPE equipment for beginners—experienced computer enthusiast. Teletype machines, parts, supplies. Catalog \$1.00. **ATLANTIC SALES,** 3730 Nautilus, Brooklyn, NY 11224. Tel: (212) 372-0349

FREE catalog. IC's, Semi's. **CORONET ELECTRONICS,** 649A Notre Dame W., Montreal, Que. Canada, H3C-1H8. US Inquiries.

PLANS & KITS

HATE commercials? Device for color TV's kills commercials automatically during B&W programs. Easy construction/Installation. Plans \$2.50. **ASI,** Box 273, Laguna Beach, CA 92652

DESCRAMBLERS: Several professional models that work with all scanners. Tone encoders/decoders. Scanmate, AAPP, radar detectors. Big Ears, alarms, books, kits, parts. Catalog 25 cents: **KRYSTAL KITS,** Box 445, Bentonville, AR 72712

The **BIGGEST "BRIGHTEST" BESTEST**
6 Digit LED Alarm Clock & Elapsed Timer Kit
available at this value anywhere
\$17.95 Complete

- 6-Fairchild .50" LED Displays
- 0-60 Min. Elapsed Timer
- 12 Hr. 60 cycle oper.
- AC or DC oper.
- 5375AB Nat. Clock Chip
- "Freeze" Feature on any Mode
- 24 Hr. Alarm w/snooze
- Field Tested over 6 months

The kit contains P.C. Boards, Xformer, and EVERY Part Required for the Clock and all options except Cabinet or Crystal Time Base for D.C. Oper. If desired, see below.

Clock Cases

Wood Grain, Dark Oak Finish & Filter — \$4.00
Plexiglas (Choice: Bl., Wh., Blue, Smoke) — \$3.00

Crystal Time Base Kit

for D.C. operation
\$5.95

ELECTRONIC COMPONENTS — A small SAMPLING

LM309K - 5 Volt Regulator - Raytheon	79¢
LM340T Series Regs. - 5, 6, 12, 15, & 24 V (pos.)	99¢
LM741 Op. Amp. 14 Pin Dip Pkg.	4 for 99¢
2N3055 NPN Transistor TO-3 Pkg.	59¢
2N4904 PNP (complement to 2N3055)	69¢
25 Amp - 200 Volt Full Wave Bridge	\$1.49
10 Pk - 220 Power Tab Xistors, NPN & PNP Asst.	\$1.49
15 Pk - LED's Assorted Sizes and Colors	\$1.49
Bi-Polar LED - Red/Green	\$1.00

HOBB-Y-TRONIX, INC.

Box 511, Edison, N.J. 08817

Orders must include Check - No COD's. Add \$1.00 handling for orders under \$15.00. N.J. residents - add 5% tax. Shipment via UPS unless otherwise specified.

Circle 29 on reader service card

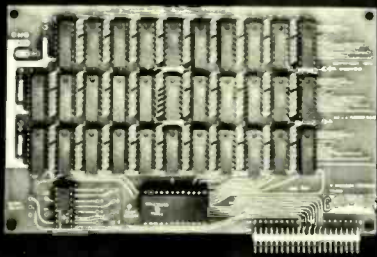

**NAKED
RAM \$88**

EASY-TO-USE 4kx8 MEMORY

This is a multipurpose, simple, and cost-effective memory. Does your 6800, 6502, 8008, SC/MP, or other processor need some memory? The **NAKED RAM** is compatible with any system using a bi-directional data buss. Own a JOLT system? The **NAKED RAM** is directly compatible... it even comes with the appropriate 40 pin connector.

This kit uses 2112s and draws under 1A; includes sockets for all ICs.

TERMS: No CODs; Cal res add tax. MasterCard®/BankAmericard® call 415-357-7007.

GODBOUT

BILL GODBOUT ELECTRONICS, BOX 2355
OAKLAND AIRPORT, CALIFORNIA 94614

Circle 31 on reader service card

**1
out of
2 who
have it
don't
know
it...**



21 million Americans have high blood pressure. But 50 percent of those who have it, don't know it.

When blood pressure goes higher than it should, and stays high, it sets the stage for heart attack or stroke.

Most cases of high blood pressure can be controlled with drugs and other advances in treatment. That's why you should see your doctor regularly. Only he can tell if you need help.

A public service message from your Heart Association



7400N TTL

SN7400N	.16	SN7453N	.27	SN74150N	1.00
SN7401N	.16	SN7454N	.20	SN74151N	.79
SN7402N	.21	SN7455A	.25	SN74153N	.85
SN7403N	.16	SN7456A	.22	SN74154N	1.25
SN7404N	.18	SN7407N	.45	SN74155N	.99
SN7405N	.24	SN7417N	.69	SN74156N	.99
SN7406N	.20	SN7472N	.39	SN74157N	.99
SN7407N	.29	SN7473N	.37	SN74158N	1.25
SN7408N	.25	SN7474N	.32	SN74161N	.99
SN7409N	.18	SN7475N	.50	SN74163N	.99
SN7410N	.25	SN7476N	.32	SN74164N	1.10
SN7411N	.30	SN7477N	5.00	SN74165N	1.10
SN7412N	.33	SN7480N	.59	SN74166N	1.25
SN7413N	.45	SN7482N	.90	SN74167N	5.50
SN7414N	.70	SN7483N	.70	SN74170N	2.10
SN7415N	.35	SN7485A	.89	SN74172N	18.00
SN7417N	.35	SN7486N	.89	SN74173N	1.50
SN7420N	.21	SN7488N	.50	SN74174N	2.90
SN7421N	.33	SN7489N	2.25	SN74175N	.99
SN7422N	.49	SN7490N	.45	SN74176N	.30
SN7423N	.37	SN7491N	.75	SN74177N	.90
SN7425N	.29	SN7492N	.45	SN74180N	2.90
SN7426N	.37	SN7493N	.31	SN74181N	2.10
SN7427N	.37	SN7494N	.49	SN74182N	.95
SN7429N	.42	SN7495N	.49	SN74184N	1.95
SN7430N	.26	SN7496N	.89	SN74185N	2.20
SN7432N	.31	SN7497N	.70	SN74186A	2.25
SN7437N	.27	SN74100N	1.00	SN74187N	6.00
SN7438N	.27	SN74107N	.39	SN74190N	1.19
SN7439N	.25	SN74121N	.39	SN74191N	1.25
SN7440N	.15	SN74122N	.70	SN74192N	.89
SN7441N	.89	SN74123N	.70	SN74193N	.89
SN7442N	.59	SN74125N	.60	SN74194N	1.25
SN7443N	.75	SN74126N	.60	SN74195N	.75
SN7444N	.75	SN74127N	1.00	SN74196N	1.25
SN7445N	.75	SN74136N	.95	SN74197N	1.75
SN7446N	.81	SN74141N	1.15	SN74198N	1.75
SN7447N	.69	SN74142N	4.00	SN74199N	1.75
SN7448N	.79	SN74143N	4.50	SN74200N	5.59
SN7450N	.26	SN74144N	4.50	SN74209N	2.25
SN7451N	.27	SN74145N	1.15	SN74251N	1.79
		SN74147N	2.35	SN74284N	6.00
		SN74148N	2.00	SN74285N	6.00

MANY OTHERS AVAILABLE ON REQUEST
20% Discount for 100 Combined 7400's

CMOS

CD4000	.25	74C04N	.75
CD4001	.25	74C05	.65
CD4002	.25	74C06	.65
CD4003	.25	74C07	.65
CD4009	.25	74C10	1.15
CD4010	.25	74C11	1.15
CD4011	.25	74C12	1.15
CD4012	.25	74C13	1.15
CD4013	.25	74C14	1.15
CD4014	.25	74C15	1.15
CD4015	.25	74C16	1.15
CD4016	.25	74C17	1.15
CD4017	.25	74C18	1.15
CD4018	.25	74C19	1.15
CD4019	.25	74C20	1.15
CD4020	.25	74C21	1.15
CD4021	.25	74C22	1.15
CD4022	.25	74C23	1.15
CD4023	.25	74C24	1.15
CD4024	.25	74C25	1.15
CD4025	.25	74C26	1.15
CD4027	.25	74C27	1.15
CD4028	.25	74C28	1.15
CD4029	.25	74C29	1.15
CD4030	.25	74C30	1.15

LINEAR

LM309N	.80	LM1351N	1.65
LM301H	.35	LM1414N	1.75
LM301CN	.35	LM1458C	.65
LM302H	.75	LM1496N	.95
LM304H	1.00	LM1509N	1.85
LM305H	.95	LM1511N	1.95
LM307CN	.35	LM2901N	2.95
LM308H	1.00	LM3065N	.69
LM308CN	1.00	LM3066N	.55
LM309N	1.15	LM3090N	.89
LM309K	.89	LM3090*	1.25
LM310CN	1.15	LM3556N	1.85
LM311H	.90	MC5558V	1.00
LM311N	.90	LM7255N	.90
LM318CN	1.50	LM7535N	1.25
LM319N	1.30	NE5608*	4.95
LM319D	1.00	NE5618*	4.95
LM320K-5	1.35	NE5629*	5.00
LM320K-5.2	1.35	NE5630*	5.00
LM320K-5.2	1.35	NE5631*	5.00
LM320K-5.2	1.35	NE5632*	5.00
LM320K-5.2	1.35	NE5633*	5.00
LM320K-5.2	1.35	NE5634*	5.00
LM320K-5.2	1.35	NE5635*	5.00
LM320K-5.2	1.35	NE5636*	5.00
LM320K-5.2	1.35	NE5637*	5.00
LM320K-5.2	1.35	NE5638*	5.00
LM320K-5.2	1.35	NE5639*	5.00
LM320K-5.2	1.35	NE5640*	5.00
LM320K-5.2	1.35	NE5641*	5.00
LM320K-5.2	1.35	NE5642*	5.00
LM320K-5.2	1.35	NE5643*	5.00
LM320K-5.2	1.35	NE5644*	5.00
LM320K-5.2	1.35	NE5645*	5.00
LM320K-5.2	1.35	NE5646*	5.00
LM320K-5.2	1.35	NE5647*	5.00
LM320K-5.2	1.35	NE5648*	5.00
LM320K-5.2	1.35	NE5649*	5.00
LM320K-5.2	1.35	NE5650*	5.00
LM320K-5.2	1.35	NE5651*	5.00
LM320K-5.2	1.35	NE5652*	5.00
LM320K-5.2	1.35	NE5653*	5.00
LM320K-5.2	1.35	NE5654*	5.00
LM320K-5.2	1.35	NE5655*	5.00
LM320K-5.2	1.35	NE5656*	5.00
LM320K-5.2	1.35	NE5657*	5.00
LM320K-5.2	1.35	NE5658*	5.00
LM320K-5.2	1.35	NE5659*	5.00
LM320K-5.2	1.35	NE5660*	5.00
LM320K-5.2	1.35	NE5661*	5.00
LM320K-5.2	1.35	NE5662*	5.00
LM320K-5.2	1.35	NE5663*	5.00
LM320K-5.2	1.35	NE5664*	5.00
LM320K-5.2	1.35	NE5665*	5.00
LM320K-5.2	1.35	NE5666*	5.00
LM320K-5.2	1.35	NE5667*	5.00
LM320K-5.2	1.35	NE5668*	5.00
LM320K-5.2	1.35	NE5669*	5.00
LM320K-5.2	1.35	NE5670*	5.00
LM320K-5.2	1.35	NE5671*	5.00
LM320K-5.2	1.35	NE5672*	5.00
LM320K-5.2	1.35	NE5673*	5.00
LM320K-5.2	1.35	NE5674*	5.00
LM320K-5.2	1.35	NE5675*	5.00
LM320K-5.2	1.35	NE5676*	5.00
LM320K-5.2	1.35	NE5677*	5.00
LM320K-5.2	1.35	NE5678*	5.00
LM320K-5.2	1.35	NE5679*	5.00
LM320K-5.2	1.35	NE5680*	5.00
LM320K-5.2	1.35	NE5681*	5.00
LM320K-5.2	1.35	NE5682*	5.00
LM320K-5.2	1.35	NE5683*	5.00
LM320K-5.2	1.35	NE5684*	5.00
LM320K-5.2	1.35	NE5685*	5.00
LM320K-5.2	1.35	NE5686*	5.00
LM320K-5.2	1.35	NE5687*	5.00
LM320K-5.2	1.35	NE5688*	5.00
LM320K-5.2	1.35	NE5689*	5.00
LM320K-5.2	1.35	NE5690*	5.00
LM320K-5.2	1.35	NE5691*	5.00
LM320K-5.2	1.35	NE5692*	5.00
LM320K-5.2	1.35	NE5693*	5.00
LM320K-5.2	1.35	NE5694*	5.00
LM320K-5.2	1.35	NE5695*	5.00
LM320K-5.2	1.35	NE5696*	5.00
LM320K-5.2	1.35	NE5697*	5.00
LM320K-5.2	1.35	NE5698*	5.00
LM320K-5.2	1.35	NE5699*	5.00
LM320K-5.2	1.35	NE5700*	5.00
LM320K-5.2	1.35	NE5701*	5.00
LM320K-5.2	1.35	NE5702*	5.00
LM320K-5.2	1.35	NE5703*	5.00
LM320K-5.2	1.35	NE5704*	5.00
LM320K-5.2	1.35	NE5705*	5.00
LM320K-5.2	1.35	NE5706*	5.00
LM320K-5.2	1.35	NE5707*	5.00
LM320K-5.2	1.35	NE5708*	5.00
LM320K-5.2	1.35	NE5709*	5.00
LM320K-5.2	1.35	NE5710*	5.00
LM320K-5.2	1.35	NE5711*	5.00
LM320K-5.2	1.35	NE5712*	5.00
LM320K-5.2	1.35	NE5713*	5.00
LM320K-5.2	1.35	NE5714*	5.00
LM320K-5.2	1.35	NE5715*	5.00
LM320K-5.2	1.35	NE5716*	5.00
LM320K-5.2	1.35	NE5717*	5.00
LM320K-5.2	1.35	NE5718*	5.00
LM320K-5.2	1.35	NE5719*	5.00
LM320K-5.2	1.35	NE5720*	5.00
LM320K-5.2	1.35	NE5721*	5.00
LM320K-5.2	1.35	NE5722*	5.00
LM320K-5.2	1.35	NE5723*	5.00
LM320K-5.2	1.35	NE5724*	5.00
LM320K-5.2	1.35	NE5725*	5.00
LM320K-5.2	1.35	NE5726*	5.00
LM320K-5.2	1.35	NE5727*	5.00
LM320K-5.2	1.35	NE5728*	5.00
LM320K-5.2	1.35	NE5729*	5.00
LM320K-5.2	1.35	NE5730*	5.00
LM320K-5.2	1.35	NE5731*	5.00
LM320K-5.2	1.35	NE5732*	5.00
LM320K-5.2	1.35	NE5733*	5.00
LM320K-5.2	1.35	NE5734*	5.00
LM320K-5.2	1.35	NE5735*	5.00
LM320K-5.2	1.35	NE5736*	5.00
LM320K-5.2	1.35	NE5737*	5.00
LM320K-5.2	1.35	NE5738*	5.00
LM320K-5.2	1.35	NE5739*	5.00
LM320K-5.2	1.35	NE5740*	5.00
LM320K-5.2	1.35	NE5741*	5.00
LM320K-5.2	1.35	NE5742*	5.00
LM320K-5.2	1.35	NE5743*	5.00
LM320K-5.2	1.35	NE5744*	5.00
LM320K-5.2	1.35	NE5745*	5.00
LM320K-5.2	1.35	NE5746*	5.00
LM320K-5.2	1.35	NE5747*	5.00
LM320K-5.2	1.35	NE5748*	5.00
LM320K-5.2	1.35	NE5749*	5.00
LM320K-5.2	1.35	NE5750*	5.00
LM320K-5.2	1.35	NE5751*	5.00
LM320K-5.2	1.35	NE5752*	5.00
LM320K-5.2	1.35	NE5753*	5.00
LM320K-5.2	1.35	NE5754*	5.00
LM320K-5.2	1.35	NE5755*	5.00
LM320K-5.2	1.35	NE5756*	5.00
LM320K-5.2	1.35	NE5757*	5.00
LM320K-5.2	1.35	NE5758*	5.00
LM320K-5.2	1.35	NE5759*	5.00
LM320K-5.2	1.35	NE5760*	5.00
LM320K-5.2	1.35	NE5761*	5.00
LM320K-5.2	1.35	NE5762*	5.00
LM320K-5.2	1.35	NE5763*	5.00
LM320K-5.2	1.35	NE5764*	5.00
LM320K-5.2	1.35	NE5765*	5.00
LM320K-5.2	1.35	NE5766*	5.00
LM320K-5.2	1.35	NE5767*	5.00
LM320K-5.2	1.35	NE5768*	5.00
LM320K-5.2	1.35	NE5769*	5.00
LM320K-5.2	1.35	NE5770*	5.00
LM320K-5.2	1.35	NE5771*	5.00
LM320K-5.2	1.35	NE5772*	5.00
LM320K-5.2	1.35	NE5773*	5.00
LM320K-5.2	1.35	NE5774*	5.00
LM320K-5.2	1.35	NE5775*	5.00
LM320K-5.2	1.35	NE5776*	5.00
LM320K-5.2	1.35	NE5777*	5.00
LM320K-5.2	1.35	NE5778*	5.00
LM320K-5.2	1.35	NE5779*	5.00
LM320K-5.2	1.35	NE5780*	5.00
LM320K-5.2	1.35	NE5781*	5.00
LM320K-5.2	1.35	NE5782*	5.00
LM320K-5.2	1.35	NE5783*	5.00
LM320K-5.2	1.35	NE5784*	5.00
LM320K-5.2	1.35	NE5785*	5.00
LM320K-5.2	1.35	NE5786*	5.00
LM320K-5.2	1.35	NE5787*	5.00
LM320K-5.2	1.35	NE5788*	5.00
LM320K-5.2	1.35	NE5789*	5.00
LM320K-5.2	1.35	NE5790*	5.00
LM320K-5.2	1.35	NE5791*	5.00
LM320K-5.2	1.35	NE	

CRYSTALS

THESE FREQUENCIES ONLY

Part #	Frequency	Case/Style	Price
CY1A	1.000 MHz	HC33/U	\$4.95
CY2A	2.000 MHz	HC33/U	\$4.95
CY3A	4.000 MHz	HC18/U	\$4.95
CY7A	5.000 MHz	HC18/U	\$4.95
CY12A	10.000 MHz	HC18/U	\$4.95
CY14A	14.31818 MHz	HC18/U	\$4.95
CY19A	18.000 MHz	HC18/U	\$4.95
CY22A	20.000 MHz	HC18/U	\$4.95
CY30B	32.000 MHz	HC18/U	\$4.95

CLOCK CHIPS — CALCULATOR CHIPS

MM5309	6 Digit, BCD Outputs, Reset PHL	\$5.95
MM5311	6 Digit, BCD Outputs, 12 or 24 Hour	4.95
MM5312	4 Digit, BCD Outputs, 1 PPS Output	4.95
MM5313	6 Digit, BCD Outputs, 1 PPS Output	4.95
MM5314	6 Digit, 12 or 24 Hour, 50 or 60 Hz	4.95
MM5315	4 Digit, Alarm, 1 PPS Output	6.95
MM5316	Watch Clock Chip, For Use With MM5841	9.95
CT7001	6 Digit, Calendar, Alarm, 12 or 24 Hour	6.95

CALCULATOR CHIPS

MM5725	6 Digit, Four Function, Dec Decimal	\$2.95
MM5738	8 Digit, 5 Function, % = $\frac{1}{x}$ %	2.95
MM5739	8 Digit, 4 Function, Floating Decimal	2.95
CT5001	12 Digit, 4 Function	3.95
CT5005	12 Digit, 4 Function with Memory	5.95
CT5030	12 Digit, 4 Function and %	7.95

MISC. MOS

MM5320	TV Camera Sync Generator	\$19.95
MM5330	4 1/2 Digit DVM Chip	9.95
MM5359	50 Hz Timebase Circuit From 3.58 MHz	5.00
MM5841	Video Generator For MM5316	18.00
MC1408-L7	7 Bit Digital to Analog Converter	10.95
LM5007	4 Decade Counter with Latches	9.95
LD110/LD111	3 1/2 Digit DVM Chip Set	25.00
95940	100 MHz - 10 Counter for Prescalers	13.95

THE NEW RCA CA3140 MOST USEFUL OP AMP SINCE THE 741 CA3140 vs. 741 at a glance

	CA3140T.S	CA741CT.S
Input Resistance R_i (M Ω)	1,500,000	2
Input Current I_i (pA)	10	80,000
Slew Rate, SR (cosec loop) (V/ μ s)	9	0.5
Gain-Bandwidth Product, f_T (MHz)	4.5	1.0

\$1.25

VECTOR WIRING PENCIL

Vector Wiring Pencil P173 consists of a hand held featherweight (under one ounce) tool which is used to guide and wrap insulated wire, tied off a self-contained replaceable bobbin, onto component leads or terminals installed on pre-punched "P" Pattern Vectorboards. Connections between the wrapped wire and component leads, parts or terminals are made by soldering. Complete with 250 ft of red wire. **\$9.50**

REPLACEMENT WIRE — BOBBINS FOR WIRING PENCIL

W36-3-A-Pkg. 3	250 ft. 36 AWG GREEN	\$2.40
W36-3-B-Pkg. 3	250 ft. 36 AWG RED	\$2.40
W36-3-C-Pkg. 3	250 ft. 36 AWG CLEAR	\$2.40
W36-3-D-Pkg. 3	250 ft. 36 AWG BLUE	\$2.40

1/16 VECTOR BOARD

Part No.	W	P-Pattern	Price
PHENOLIC			1-19 20-49
64P44 0628X1P	4.50	6.50	1.72 1.54
169P44 024X1P	4.50	17.00	3.69 3.32
64P44 062	4.50	6.50	2.07 1.86
84P44 062	4.50	8.50	2.56 2.31
169P44 062	4.50	17.00	5.04 4.53
169P44 062	8.50	17.00	9.23 8.26
EPXY GLASS	169P44 062CT	4.50	17.00 6.80 6.12
COOPER CLAD			

VECTOR TERMINALS

Part No.	Finish	25 per	50 per
Series	Gold <td>Tinned <td>Post Size</td> </td>	Tinned <td>Post Size</td>	Post Size
T44	T44-1	T44	025 sq
T46	T46-1	T46	028 sq
T49	T49A	T49	025 sq
T42-1	PKL 100	Terminals	\$3.50 C \$13.00M

DIP SWITCH

These switches feature seven SPST slide switches in a molded dip. They are ideally suited for microprocessor applications. **\$1.95**

SCR AND FW BRIDGE RECTIFIERS

C380	15A @ 200V	SCR	\$1.95
C38M	15A @ 200V	SCR	1.95
2N2328	3.5A @ 200V	SCR	.50
MDA 980-1	25A @ 50V	PW BRIDGE REC.	1.95
MDA 980-3	25A @ 200V	PW BRIDGE REC.	1.95

64 KEY KEYBOARD

This keyboard features 64 unenclosed SPST keys unattached to any kind of P.C.B. A very solid molded plastic 13" x 4" base suits most applications. **\$19.95**

HDD165 16 LINE TO FOUR BIT PARALLEL KEYBOARD ENCODER \$7.95

JOYSTICK

These joysticks feature four 100K potentiometers, that vary resistance proportional to the angle of the stick. Sturdy metal construction with plastics components only at the movable joint. Perfect for electronic games and instrumentation. **\$9.95 ea.**

MICROPROCESSOR COMPONENTS

8080 SUPPORT DEVICES

8080A	8212	8 BIT INPUT/OUTPUT PORT FOR 8080	\$ 5.95	8080	
\$37.95	8224	CLOCK GENERATOR AND DRIVER FOR 8080	12.95	\$24.95	
	8228	SYSTEM CONTROLLER AND BUS DRIVER FOR 8080	12.95		

CPU'S		RAM'S					
8008	8 BIT CPU	\$19.95	1101	256 x 1	Static	\$ 2.25	
8080	Super 8008	24.95	1103	1024 x 1	Dynamic	2.25	
8080A	Super 8008	37.95	2101	256 x 1	Static	6.95	
			2102	1024 x 1	Static	1.95	
			2107	4096 x 1	Dynamic	19.95	
			2111	256 x 4	Static	7.95	
			2100	1024 x 1	MMIOS	29.95	
			6.00	7489	16 x 4	Static	2.49
			3.95	8101	256 x 4	Static	7.95
			4.00	8111	256 x 4	Static	7.95
			3.25	8599	16 x 4	Static	3.49
			7.95	91102	1024 x 1	Static	2.49
			6.95	74200	256 x 1	Static	6.95
			3.95	93410	256 x 1	Static	1.75

UART'S		PARMS				
AY-5-1013	30K Baud	\$ 6.95	17024	2048	Famous	\$15.95
			5203	2048	Famous	14.95
			62523	32 x 8	Open C	8.00
			825123	32 x 8	Trotate	5.00
			745287	1024	Static	7.95
			3601	256 x 4	Fast	5.00

2K RAM SPECIAL

MM5262 Fully decoded 2Kx1 Dynamic RAM. All inputs except clocks are TTL compatible. Provides a 635 ns minimum access time, and requires a +5, +8.5, and -15V power supply. Low power. Memory non-volatile using battery back up. **\$0.99 ea. (0.05 cents per bit)**

Special Requested Items

RC1194	Dual Trace V Reg	\$ 5.95	N8797	\$ 2.00	MKS007	\$10.95	MC4044	\$ 4.50
RC4195	-15V Track Reg	3.25	0424P	2.25	8203	5.25	LM3309	1.25
F9368	Decoder	3.95	DM6130	3.25	8267	2.75	MM5200	19.95
LD110/111	DVM Chip Set	25.00	CD4520	\$2.50	8288	1.15	4072AE	4.50
CL3130	Super CMOS Op Amp	39.00	MC14016	.56	8826	3.00	7422	1.50
MC1408-L7	D/A	9.95	2525	6.00	9580	.80	7497	4.00
F3341	R/D	6.95	2527	3.95	4511AE	2.50	74186	5.00
MM5841	Character Dialer	18.00	CD4518	2.50	XR4136	2.00	74279	9.00
AY5-9100	Push Button Dialer	17.50	MM5305	5.95	4564AE	3.00	82590	4.00

WE'LL BE HAPPY TO QUOTE ON YOUR SPECIAL PARTS — MCT-2E

Continental Specialties

PROTO POWER!

POWER FOR THE PROFESSIONAL

For the economy-minded experimenter

Proto Board 100

Here's a low cost, big 100 capacity board that will do the heavy lifting of DTL, TTL and the best of the Proto Board range — complete down to the last "off" bolt and screw. Includes 2 1/2 100 Socket, 1 1/2 100 Bus Strip, 2 1/2 wire binding posts, 4 custom built screws, nuts, washers and easy assembly instructions. **\$19.95**

Proto Board 104
Size 1 1/2" x 3" x 1/4" (includes 1 1/2 100 Socket, 1 1/2 100 Bus Strip, 2 1/2 wire binding posts, 4 custom built screws, nuts, washers and easy assembly instructions. **\$7.95**

COMPLETE KIT
DESIGN MATE 1
This kit includes all the discrete components needed to build a 100 Socket Proto Board. Includes 1 1/2 100 Socket, 1 1/2 100 Bus Strip, 2 1/2 wire binding posts, 4 custom built screws, nuts, washers and easy assembly instructions. **\$9.95**

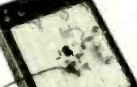

\$75 Proto Board 203

Protoboard Prototyping with 5 Volt, 1 Watt Regulated Power Supply Included!

THE MINI-BREADBOARD BUDGET KIT

Proto Board 181 Compact Resistorless 10-14 pin DIP capacity 5.8 inch x 4.3 inch **29.95**

Proto Board 182 Compact 10-14 pin DIP capacity 7.7 inch x 4.3 inch **39.95**

Proto Board 183 2.75 inch wide 10-14 pin DIP capacity 7.7 inch x 4.3 inch **\$9.95**

Proto Board 6
This kit includes all the discrete components needed to build a 6 Pin Proto Board. Includes 6 Pin Proto Board, 6 Pin Proto Board, 6 Pin Proto Board, 6 Pin Proto Board, 6 Pin Proto Board, 6 Pin Proto Board. **\$19.95**

LOGIC MONITOR
Simultaneously displays static and dynamic logic states of DTL, TTL, CMOS or DMS DIP IC's. Pocket size. **\$24.95**

SPECIAL!

OT-595	OT-185
OT-598	OT-125
OT-475	OT-85
OT-478	OT-355
OT-358	OT-75

DIGITAL CLOCK KIT — 3 1/2 INCH DIGITS

This clock features big 3 1/2" high digits for viewing in offices, auditoriums, etc. Each digit is formed by 31 bright DTL-LED's. The clock operates from 117 VAC, has either 12 or 24 hr. operation. The 6 digit version is 2 1/2" x 1 1/4" and the 4 digit is 1 1/2" x 1 1/4". Kits come complete with all components, case and transformer. Specify 12 or 24 Hr. When Ordering

4 DIGIT KIT	\$49.95	4 DIGIT ASSEMBLED	\$59.95
6 DIGIT KIT	\$69.95	6 DIGIT ASSEMBLED	\$79.95

Satisfaction Guaranteed, \$5.00 Min. Order, U.S. Funds. California Residents — Add 6% Sales Tax — Data Sheets 25c each. Send a 13c Stamp (postage) for a FREE 1976 Catalog

JAMES

1021 HOWARD AVE., SAN CARLOS, CA. 94070
PHONE ORDERS — (415) 592-8097

Circle 75 on reader service card

5 FUNCTION ELECTRONIC CALCULATOR

RAOOFIN MODEL 8P

\$8.95

FEATURES:

- 6 Digit Display
- 5 Functions consists of addition, subtraction, multiplication, division, percentage, with constant on all functions, with full floating decimal point.
- Power source is 6 piece 9V DC Battery 00GP, jack for AC adapter
- Black superline grained finish plastic cabinet



5 FUNCTION ELECTRONIC CALCULATOR WITH WALLET-NOTEBOOK AND POCKET CHECKBOOK

RAOOFIN MODEL 1710

\$19.95

FEATURES:

- 8 Digit Display
- 5 Functions consists of addition, subtraction, multiplication, division, percentage, with constant on all functions, with full floating decimal point.
- Power source is 6 AAA cells 9 V D.C.
- Wallet is 2 tone texon, cabinet is black plastic



IMC 3 1/2 DIGIT DVM KIT

This 0-2 VDC, .05 per cent digital voltmeter features the Motorola 3 1/2 digit DVM chip set. It has a 4" LED display and operates from a single +5V power supply. The unit is provided complete with an injection molded black plastic case complete with Bezel. An optional power supply is available which fits into the same case as the 0-2V DVM allowing 117 VAC operation.

A. 0-2V DVM with Case

\$49.95

B. 5V Power Supply

\$14.95

JE700 CLOCK

The JE700 is a low cost digital clock, but is a very high quality unit. The unit features a simulated walnut case with dimensions of 6" x 2 1/2" x 1". It utilizes a MAN72 high brightness red-emit, and the MM5314 clock chip.

115 VAC **\$17.95**

Liquid Crystal Temperature Display

Six Digital Light Emitting Diode Display

This clock makes an attractive addition to any desk. It has an extruded, black anodized aluminum case. It displays hours, minutes, and seconds with .11 inch displays, and comes complete with a liquid crystal thermometer. It operates off 115 VAC at 50 or 60 Hz. **\$24.95**

This large digit clock (.6" hours & minutes, .3" seconds) features the MM5314 clock chip. It operates from 117 VAC, and will operate in either a 12 or 24 hour mode. The clock is complete with a walnut grain case, and has fast set, slow set, and hold time set features.

KIT - ALL COMPONENTS & CASE \$34.95
WIRED & ASSEMBLED \$39.95

JE803 PROBE

The Logic Probe is a unit which is for the most part indispensable in trouble shooting logic families TTL, DTL, RTL, CMOS. It derives the power it needs to operate directly off of the circuit under test; drawing a scant 10 mA max. If it uses a MAN72 resistor to indicate any of the following states by its symbols: (H) - 1 (LOW) - 0 (PULSE) - P. The Probe can detect high frequency pulses to 45 MHz. It can be used at MOS levels or circuit function with result.

\$9.95 Per Kit printed circuit board

TTL 5V 1A Supply

This is a standard TTL power supply using the well known LM309K regulator IC to provide a solid 1 AMP of current at 5 volts. We try to make things easy for you by providing everything you need in one package, including the "sawdust" for only **\$9.95 Per Kit**

exelar

This watch is manufactured by National Semiconductor. It provides 5 functions; hours, minutes, seconds, date, A.M. indicator dot. Accuracy is assured to 5 seconds per month by precision quartz crystal. If something should go wrong with the watch, repair is assured within 48 hours after it is received. Complete with steel black leather band.

ES4-Y5
3 MICRON GOLD PLATE BEZEL
\$29.95

DIGITAL ALARM CLOCK

This 4 digit Novus Alarm Clock is a very reliable and smartly styled unit. It provides such features as an alarm settable to any minute of the day, a 7 minutes snooze alarm, a power failure indicator, and even an A.M./P.M. indicator. **\$19.95**



NOT A KIT

Babylon-Pac super SALE! Each pac only \$1.98

All pacs are first quality (no fallouts), tested and guaranteed.

Linear pac 8 assorted linear in mini-DIP or TO-5/741 on amp, LM307 op amp, LM 701 80-11F amp, with data and circuits \$1.98	Flip-Flop pac 10 assorted Flip-Flops, Dual JK's, 857's, and low power TTL's, with data \$1.98	Regulators A LM232 DIP variable regulators, 7-40V, with data \$1.98
TTL Gates 15 assorted DIP's 7400 series-7420, 7430, 7440, etc., all prime, marked etc., with data \$1.98	LED pac 10 assorted discrete LED's-green, red, and infra-red, with data \$1.98	Comparator pac 5 assorted DIP's--LM311, 710, 711, with data \$1.98
UNTESTED PACS 30 CMOS pac's, all factory marked- \$1.98	Stud Rectifiers 20 amp stud rectifiers, mostly 100V+ \$1.98	Resistors 100 resistors of any single standard value from 2.2 ohm to 1M ohm. Not an ass't. \$1.98
Transistors 40 assorted 2N or 2N series-2N3904, 2N3055, and some germanium, untested, all connections available. \$1.98	IC Assortment 100 untested IC's, all DIP, mostly TTL--some marked, housemarked, or unmarked. \$1.98	Switches 8 SPST momentary contact push button N.O. Rec button fits in approx. panel, with lock washer and mounting nut. \$1.98
Diodes 100 germanium computer signal diodes with leads trimmed for PCB mounting. \$1.98	739 pac 5 Linear--dual low noise stereo amplifier 739. With data. \$1.98	Buy 5 pacs for \$9.90 and pac-a-pac for \$10C

Capacitors
PCB vertical mount dipped tantalum capacitors--all brand new market parts. Values: 10µF 25V; 6.8µF 50V; 33µF 10V; 4.7µF 18V. **25¢ each**

SPACE AGE CLOCK KIT 1235
Instructions & parts - 12 or 24 hour format, 24 hour format. Four digit clock kit includes all parts for complete clock: 3 1/2" x 2 1/2" -FND 70 readouts -TP5314 clock chip & all transistors, etc. -retroplated aluminum case -cord with toggle switch. **\$16.95**

POTTER BRUMFIELD
Type 100 relay & PRT 3A Contacts
2N2222 NPN transistor
TD-92: 1.0µ 24V DC 741.50
40V 650 coil
EACH 20¢ 120V AC \$1.75
10/51.75 (210 x 98 coil)

FULL WAVE BRIDGE RECTIFIERS
10A, 100V "11" style, similar to Motorola M0590. Each \$1.00 10 for \$9.00

Send a stamp for our flyer listing more money-saving bargains!

4811 Myrtle Ave. Sacramento, CA 95841
Phone (916) 334-2161

BABYLON ELECTRONICS **BANKAMERICAN**

Orders under \$7.00 add \$1.00 postage and handling. Residents of Cal. add sales tax. Orders shipped promptly. \$10 minimum on C.O.D.'s.

free catalog

over 50 electronics projects for the: Hobbyist, Experimenter, Student, Engineer

Do-it-yourselfer

- Many under \$10
- Instructions included with each project
- Hundreds of other electronic components

Send today for FREE CATALOG

Graymark

Subsidiary of Buck Engineering Co., Inc.
Box 17359 • Dept. RE96 • Irvine, CA 92713

Circle 56 on reader service card

USED TEKTRONIX & HP TEST EQUIPMENT

Write: P.T.I., Div. 14, P.O. Box 8699, White Bear Lake, Mn 55110

SEMICONDUCTOR and parts literature, J. & J. ELECTRONICS, Box 1437R, Winnipeg, Manitoba, Canada. U.S. Inquiries Invited.

CANADA'S LOWEST PRICED MAIL ORDER SUPPLIER
IC Sockets, Rectifiers, LEDs, TTL, CMOS, Linear, Transistors.

some typical prices include:
mini-dip 741. \$ 45 SN7400 \$ 29 CD4002 \$ 29
CD4025 29 CD4001 29 CD4027 1.05
SN74LS279 1.22 SN7433 49 SN7443 93

For complete catalogue, send 25¢ for handling, or a stamped, self-addressed, 9X12 envelope to P.O. Box 181, Station G, Toronto, Ontario, M4M 3G7.

J & J Electronics Limited

CASSETTES/LABELS

Plain white cassette labels, Norolco cassette cleaners, famous brand cassettes. Send for open reel and cassette discount catalog. 1-9 10-99 100 1000 10M

Cassette Labels .02 .015 .01 .006
Norolco Cassette Cleaner .65 .60 .55 .50 .45
10" Fiberglass used 3/4" Hole 50 .50 .40 .35 .30
Plus Postage by Weight and Zone. Minimum Order \$5.00
OPEN REEL STEREO TAPE BUYERS!

We've Got the "Sprit!" The Prices And The Address To Prove It

Saxitone's Bicentennial Tape Shoppe
1276 Columbia Rd., N.W., Wash. D.C. 20009

C-MOS PROBE

will convert your voltmeter into a sensitive FET INPUT millivoltmeter. Complete kit \$11.95 plus shipping. Also - Temp Meters - Power Supplies - Design Consoles.

Send for FREE CATALOG

SCIENTIFIC INSTRUMENTS
BOX 1054R LIVERMORE CA 94550

ACE OF THE MONTH SPECIALS

All new ENGINEERING APPRAISAL ASSORTMENTS first quality

200 ELECTROLYTIC ASSORTMENT \$9.95 MINIATURE ALUMINUM axial lead FROM 1µF/50V TO 470µF/25V	1% PRECISION RESISTORS 200 for \$4.95 Assortment contains a balanced inventory
DIPPED POLYESTER FILM CAPACITORS 100 for \$4.95	DISC CAP ASSORTMENT includes 22 µF 250V 30 µF 350V 47 µF 500V 100 µF 50V values 100 of 100µF 022µF 200 PCS FOR \$3.85
KEYBOARD ASSORTMENT CALCULATOR & COMPUTER 5 for \$9.95	SLIDE SWITCH ASSORTMENT standard and miniature 40 for \$5.00
AC adapter ASSORTMENT 4 DIFFERENT models for \$9.95	POWER CORD ASSORTMENT 6 for \$2.95 2 and 3 conductor 6-8 ft. U.L. Listed

ACOUSTIC COUPLER
This coupler was manufactured by Novation, Inc. Tarzana, California for use in Texas Instrument's model 725 Electronic Data Terminal. It is compatible with Bell 103 and 113 data sets or equivalent. The coupler operates asynchronously to a maximum speed of 450 baud in the full-or-half-duplex mode coupled to a standard telephone handset. Transmit freq. is 1270Hz for mark and 1070Hz for space. Receive frequency is 2225Hz for mark and 2025Hz for space. Unit requires ± 12 VOLTS and ± 5 VOLTS for operation. Complete with schematic & all pertinent information, fully reconditioned, calibrated, and guaranteed. \$47.50

ASCII COMPUTER KEYBOARDS
These keyboards were manufactured for use on Texas Instrument's line of Silent 700 series data terminals. They are fully encoded with TTL large scale integrated circuits (T.I. TMS-5000 in 28 pin socket). Additional IC's provide a parallel 7 bit, without parity, code plus a strobe signal indicating "valid" data and six other independent outputs for those special keys which are not encoded. Internal circuitry provides for two key rollover and de-bounce. Output is on standard 10 pin double readout connector for data and power input. And 8 pin double readout connector for six special switch functions.
KB 6 Clear/Pander 720627-1 New tested \$39.95
T.I. Part number: 959327-1 Used tested \$26.95
A 56 key ASCII encoded alphanumeric keyboard with six extra switch closures to ground marked HERE IS, PAPER ADV., BREAK, REPEAT, TAPE → TAPE ←

TMS 5000 ASCII keyboard encoder with data \$14.95
ASR33 Teletype Code

SWITCHCRAFT Micro-Jax
100 — \$2.95
1000 — 25.00
TR-2A 1000 — 199.50
10M — 1250.00

SPEEDY BEND
By PRODUCTION DEVICES
\$1.95
NEW \$2.95

BISMUTH ALLOY.
Melts in boiling water
4 oz. ingot \$3.95

MOLEX I.C. PINS 1000 for \$6.95

Kynar solid silver-plated wire wrap wire
30 AWG Blue 1000 FT SPOOL 9.95
26 AWG Red or Black 1000 FT SPOOL 10.95

PRINTED CIRCUIT BOARD G-10-1/16" thick, unetched copper clad 1 oz. 2 sides
Size 1 10 100
3x6" 50 2.50 19.95
4x12" 1.00 5.00 39.95
8x8" 1.50 9.95 59.75

TMS 4030 JL, 4096-BIT DYNAMIC RAM Low Power 400 mW \$9.95
with data and 22-Pin SOCKET removed from sockets 8 FOR \$64.95
Tested and guaranteed

NE-2 NEON
100 — 9.95
1000 — 49.95
10M — \$350.00

BAUDOT KEYBOARD
KB-5
ELECTRICAL REQUIREMENTS
The keyboard requires 5 volts.
All outputs are capable of driving a minimum of one standard TTL load. Logic level "1" is defined as a voltage between .2 and .5 25 volts. Logic level "0" is defined as a voltage between .6 volts and 0.0 volts.
New \$29.95

AC adapter \$3.00 ea.
INPUT 115 Volts, 50-60 Hertz
OUTPUT 8 VAC 100 Ma.
10 for \$25.00

FUSE HOLDERS FOR 3AG FUSES
HKP-CC 10 for \$2.95

CLOCK POWER TRANSFORMER P.C. Mount
PRIMARY 117 VOLT 60 Hz
OUTPUT 1 OUTPUT 2
VAC DCma VAC DCma
20CT 50 80 20 10 for \$15.00

C&K 8532ZQ
10 for \$4.95

1N914B 100 for 6.95 **2N5449 50v 800-mA 6/31.00 100 for 12.50**

Our Prices Include Postage

ACE ELECTRONIC PARTS
5400 Mitchelldale, B-8
Houston, Texas 77092
Phone (713) 688-8114

TERMS: We pay postage, unless otherwise specified. Include check or money order, no COD. Texas residents add 5% sales tax. Canada and Mexico add \$2.50. Overseas countries add \$5.00.
We will ship UPS unless otherwise specified.
ORDERS OVER 10 lbs. are shipped Collect.
TWX 910-881-2411

SURPRISE! Build inexpensively, the most unusual test instruments, futuristic gadgets using numerical readouts! Catalogue free! **GBS, Box 100B, Greenbank, WV 24944**



ORGAN KITS KEYBOARDS

THE ULTIMATE IN DESIGN AND SOUND
FREE LITERATURE

Wurlitzer reproductions

DEVTRONIX ORGAN PRODUCTS, Dept. 4B
5872 Anapola Dr. • San Jose, CA 95129

WANTED

QUICK cash for electronic equipment, components, unused tubes. Send list now! **BARRY, 512 Broadway, New York, NY 10012, 212 Walker 5-7000**

AGENTS wanted! LCD/LED wrist watch, excellent quality, \$3.00 (refundable). **TAYOR-PAUL, 980 Greene Ave., Brooklyn, NY 11221**

WANTED Hycon oscilloscope model 622-D power transformer. **BOB JACKSON, 648 Broadway, Venice, CA 90291**

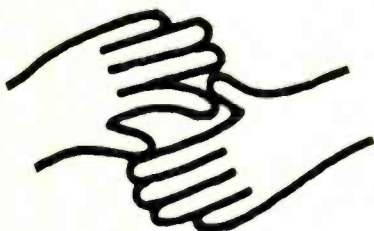

Red Cross. The Good Neighbor.

POLY PAKS

CUSTOMERS HAVE CLAMORED FOR THIS MONEY-SAVING

REPEAT SALE



Order by Cat. No. 9R1983 & Type No. below

Type	Sale	2 for	Type	Sale	2 for
SN7400	.22	.23	SN7494	.82	.83
SN7401	.22	.23	SN7495	.82	.87
SN7402	.22	.23	SN7496	.86	.87
SN7403	.22	.23	SN74125	1.29	1.30
SN7404	.24	.25	SN74126	1.29	1.30
SN7406	.36	.37	SN74132	1.95	1.96
SN7407	.46	.47	SN74141	1.12	1.13
SN7408	.22	.23	SN74145	1.69	1.70
SN7409	.52	.53	SN74148	3.25	3.26
SN7410	.22	.23	SN74165	1.59	1.60
SN7411	.27	.28	SN74153	1.10	1.11
SN7412	2.75	2.76	SN74154	1.53	1.54
SN7420	.22	.23	SN74157	1.09	1.10
SN7421	.55	.56	SN74158	1.55	1.56
SN7423	.47	.48	SN74171	1.69	1.70
SN7425	.37	.38	SN74163	1.50	1.51
SN7430	.22	.23	SN74164	1.79	1.80
SN7432	.36	.37	SN74165	1.79	1.80
SN7430	.22	.23	SN74171	1.42	1.43
SN7432	.97	.98	SN74174	1.29	1.30
SN7445	.97	.98	SN74175	1.45	1.46
SN7446	1.10	1.11	SN74176	1.59	1.60
SN7447	1.10	1.11	SN74177	1.59	1.60
SN7450	.22	.23	SN74181	3.75	3.76
SN7451	.27	.28	SN74182	1.09	1.10
SN7473	.44	.45	SN74184	2.19	2.20
SN7475	1.00	1.01	SN74190	2.75	2.76
SN7483	.99	1.00	SN74191	2.75	2.76
SN7485	1.41	1.42	SN74193	1.29	1.30
SN7486	.47	.48	SN74194	2.19	2.20
SN7488	3.95	3.96	SN74195	.89	.90
SN7489	2.25	2.26	SN74196	2.19	2.20
SN7490	1.00	1.01	SN74197	2.25	2.26
SN7491	.91	.92	SN74198	2.25	2.26
			SN74199	2.25	2.26

Cat. No.	Type	Sale	2 for
9R2310	8008	\$19.95	\$19.96
9R2585	8080	49.95	49.96
9R2855	2102	3.50	3.51
9R2856	2102-1	3.50	3.51
9R2847	1101	1.50	1.51
9R1989	1103	2.95	2.96
9R2853	5262	3.95	3.96
9R2155-A	MMS203	12.50	12.51
9R2155-B	MMS202	9.95	9.96
9R2854	1702-A	12.50	12.51

Phone: Wakefield, Mass. (617) 245-3829
Terms: Add postage. Rated: net 30
POLY PAKS MINIMUM ORDER — \$6.
P.O. BOX 942R LYNNFIELD, MASS. 01940

Circle 28 on reader service card

2 in 1

5 x 4 + 2 1/2" Display counter module 4 x 5
All other modules 3 x 5 inches

FREQUENCY COUNTER MULTIMETER

\$89.95

MODULES

- (1) DECADE COUNTER MODULE \$27.95 (4 digit 7 seg LED TTL equality latched display version available add 6.95)
- (2) TIME BASE DIVIDER CHAIN MODULE 21.95 (1MHz crystal controlled oscillator & decade divider. 1MHz, 100kHz, 10kHz, 1kHz, 100Hz, 10Hz, 1Hz outputs. Accuracy better than .001%. Module contains dual JK flip flop for stopwatch timer application.)
- (3) FREQUENCY COUNTER GATE MODULE 16.95 (Schmitt trigger input requires IV. Frequency range 30MHz. Has 1 stage softkey prescaler extending frequency range to 100MHz.)
- (4) DIGITAL MULTIMETER MODULE 29.95 (See: Frequency counter module specs for ranges and specs.)
- (5) CAPACITANCE COUNTER MODULE 19.95 (10pF to 1000pF; 1% typ. error. Requires Frequency counter system (B))
- (6) FUNCTION GENERATOR MODULE 19.95 (1Hz to 1MHz. Simultaneous sine, square, triangle wave. Adjustable duty cycle. Less than 1% distortion. 0.1% inaccuracy. Can be modified.)

SYSTEMS

- (A) FREQUENCY COUNTER-DIGITAL MULTIMETER 89.95 (Also stopwatch, timer, crystal calibrator) (Consists of modules (1), (2), (3), (4)) (Digital Multimeter, 11 MEG OHM input impedance on all ranges, 100% overrange, i.e. 0.1 999 on 0.1 000V range. AC & DC voltage range 0.1 000V, 10.00V, 100.0V, 1000V. AC & DC current range 0.1 000mA, 10.00mA, 100.0mA, 1000mA. OHMS range 0.1 000OHM, 10K, 100K.) (All attenuating & shunt networks of precision resistors. Accuracy: 3 count; 1%. Latched display version available add 6.95)
- (B) FREQUENCY COUNTER—consists of Modules (1), (2), and (3). 59.95
- (C) STOPWATCH/TIMER/TIME BASE (4 digit) 47.95 (Consists of modules (1) and (2). Time range from 10us to 9999 seconds. (166.65 min) time input: gate. Start & Stop.)
- (D) POWER SUPPLY 22.95 (± 15V at 500ma and 5V at 1.5amp. (Use for more than 4 digits))

NEW! 5 digit Frequency Counter-Digital Multimeter Kit, 40 MHz/1MHz input. Complete kit \$179.95 (can be expanded to 7 or 8 digit) (Specs. available. Write for information)

(Systems do not include hardware such as rotary switches, etc.)
Add \$1.50 Postage & Handling - Power Supply \$1.50 additional
Catalogue Residents add 6% tax
ALL MODULES ASSEMBLED AND TESTED
Please allow 3 weeks for scheduling & delivery
SEND CHECK OR MONEY ORDER TO

LIN CORPORATION

15311 S. Broadway
Gardena, California 90248
(213) 532-8809
Hours 10-4-30

Circle 93 on reader service card

INTEL 8080 CPU	\$79.50
2518 HEX 32 BIT SR	\$6.00
2102-1 1024 BIT RAM	\$ 2.60
5280 4K DYNAMIC RAM	\$12.50
5202A UV PROM	\$12.50
MM5203 UV PROM	\$12.50
1702A UV PROM	\$12.50
5204 4K PROM	\$24.95
MINIATURE MULTI-TURN TRIM POTS	
100, 500, 5K, 10K, 100K, 200K	\$ 3.50
\$.75 each	3/52.00
MULTI-TURN TRIM POTS Similar to Bourns	
3010 style 3/16" x 5/8" x 1-1/4"; 50, 100, 1K, 10K, 50K ohms	\$ 3/54.00
\$1.50 ea.	
LIGHT ACTIVATED SCR's	
TO-18, 200V 1A.	\$ 1.75

TRANSISTOR SPECIALS

2N3585 NPN Si TO-66	\$.95
2N3772 NPN Si TO-3	\$ 1.60
2N4908 PNP Si TO-3	\$ 1.00
2N6055 NPN Si TO-3 Darlington	\$ 1.30
2N5086 PNP Si TO-92	4/5 1.00
2N4898 PNP TO-66	\$.60
2N404 PNP GE TO-5	5/5 1.00
2N3919 NPN Si TO-3 RF	\$ 1.50
MPS4 13 NPN Si TO-92	3/5 1.00
2N3767 NPN Si TO-66	\$.70
2N2222 NPN Si TO-18	5/5 1.00
2N3055 NPN Si TO-3	\$.80
2N3904 NPN Si TO-92	5/5 1.00
2N3906 PNP Si TO-92	5/5 1.00
2N5296 NPN Si TO-220	\$.50
2N6109 PNP Si TO-220	\$.55
2N3866 NPN Si TO-5 RF	\$.75
2N3638 PNP Si TO-5	5/5 1.00
2N6517 NPN TO-92 Si	3/5 1.00

C/MOS (DIODE CLAMPED)

74C02	25	4016	50	4035	1.18
74C10	25	4017	1.00	4042	1.90
4001	19	4018	1.20	4047	1.80
4002	22	4019	.50	4049	.50
4006	1.20	4022	1.00	4050	.50
4007	.22	4023	.25	4055	1.75
4009	.47	4024	.80	4066	.90
4010	.47	4025	.22	4071	.40
4011	.22	4027	.48	4077	.35
4012	.22	4028	1.00	4081	.35
4013	.30	4029	1.00	4076	1.20
4015	1.10	4030	.45		

LED READOUTS

FND 500-5" C.C.	\$1.75
HP 7740-3" C.C.	\$1.40
MAN-7-3" C.A.	\$1.25
NS 33-3 dig. array	\$1.35

Send 25c for our catalog featuring Transistors and Rectifiers
145 Hampshire St., Cambridge, Mass.

PRINTED CIRCUIT BOARD

4 1/2" x 6 1/2" SINGLE SIDED EPOXY BOARD 1/16" thick, unetched
\$.50 ea. 5/\$2.20
VECTOR BOARD 1" SPACING
4 1/2" x 6" SHEET \$1.50

4 WATT IR LASER DIODE \$7.95

2N 3820 P FET	\$.45
2N 5457 N FET	\$.45
2N 4891 UJT	\$.45
TIS 43 UJT	\$.35
ER 900 TRIGGER DIODES	4/31.00
2N 6028 PROG. UJT	\$.65

VERIPAX PC BOARD

This board is a 1/16" single sided paper epoxy board, 4 1/2" x 6 1/2" DRILLED and ETCHED which will hold up to 21 single 14 pin IC's or 8, 16, or LSI DIP IC's with buses for power supply connector. \$4.00

MV 5691 YELLOW-GREEN	\$1.25
BIPOLAR LED	\$.60
MT-2 PHOTO TRANS	\$.20
RED, YELLOW, GREEN OR	
AMBER LARGE LED's	ea. \$.20
14 PIN DIP SOCKETS	\$.25
16 PIN DIP SOCKETS	\$.28
MOLEX PINS	1000/\$1.00
3 PIN MINI DIP SOCKETS	\$.25
10 WATT ZENERS 3.9, 4.7, 5.6, 8.2, 12, 15, 18 OR 22V, 100, 150, 200, ...	ea. \$.60
1 WATT ZENERS 4.7, 5.6, 10, 12, 15, 18 OR 22V	ea. \$.25

Silicon Power Rectifiers

PRV	1A	3A	12A	50A	125A
100	06	14	30	80	3.70
200	07	20	35	1.15	4.25
400	09	25	50	1.40	6.50
600	11	30	70	1.80	8.50
800	15	35	90	2.30	10.50
1000	20	45	110	2.75	12.50

SILICON SOLAR CELLS

2 1/4" diameter
5V at 500 ma. \$5.00 ea., 6/\$27.50

REGULATED MODULAR POWER SUPPLIES

+ - 15 VDC AT 100ma	\$24.95
115VAC INPUT	\$27.95
5VDC AT 1A, 115VAC INPUT	\$24.95
12 VDC AT .5A	\$24.95
IN 4148 (IN914)	15/\$1.00

TANTULUM CAPACITORS

22UF 35V 5/51.00	6.8UF 35V 3/51.00
47UF 35V 5/51.00	22UF 35V \$.40
68UF 35V 5/51.00	33UF 35V \$.40
10UF 35V 5/51.00	30UF 6V 5/51.00
3.3UF 35V 4/51.00	47UF 35V \$.50
4.7UF 35V 4/51.00	100UF 35V \$.50
	150UF 15V \$.40

CT7001 ALARM CLOCK CHIP \$5.75

NATIONAL MOS DEVICES

MM1402	2.00	MMS057	2.25
MM1403	2.00	MMS058	2.75
MM1404	2.25	MMS060	2.75
MM5013	2.50	MMS061	2.50
MM5016	2.50	MMS555	4.75
MM5017	2.00	MMS556	4.75
MM5055	2.25	MMS210	1.95
MM5056	2.25	MMS260	2.95

TTL IC SERIES

74L00	25	7442	55	74126	60
7400	16	7445	75	74150	100
7401	16	7446	80	74151	80
7402	16	7447	69	74152	79
7403	18	7448	77	74154	105
7404	18	7449	35	74155	100
7405	18	7450	37	74156	100
7406	35	7451	32	74164	105
7407	33	7452	34	74165	105
7408	18	7453	32	74166	105
7409	18	7454	48	74173	135
7410	15	7455	70	74174	120
7411	25	7456	88	74175	95
7412	30	7457	39	74177	100
7413	45	7458	200	74181	210
7414	80	7459	501	74190	115
7416	33	7461	75	74191	110
7417	33	7462	49	74192	85
7420	16	7463	49	74193	85
7426	35	7464	80	74194	75
7427	28	7465	80	74195	74
7430	16	7466	73	74196	110
7432	30	7467	34	74197	150
7437	27	74121	39	74283	1.50
7438	27	74123	60	75324	1.75
7440	18	74125	60	75491	60
7441	85	74125	60	75492	60

MINIATURE DIP SWITCHES

CTS-206 4 Four SPST switches in one minidip package. \$1.50
CTS-206-8 Eight SPST switches in a 16 pin DIP package. \$2.55

AY-5-1013 A30K ser./par., Par./ser., universal UART. \$8.50

ALCO MINIATURE TOGGLE SWITCHES

MTA 106 SPDT	\$1.20
MTA 206 DPDT	\$1.70

Full Wave Bridges

200	95	1.25	2.00
400	1.15	1.50	3.00
600	1.35	1.75	4.00

SANKEN AUDIO POWER AMPS

Si 1010 G 10 WATTS	\$ 6.90
Si 1020 G 20 WATTS	\$13.95
Si 1050 G 50 WATTS	\$24.95

PRV

2A	6A	25A	
200	95	1.25	2.00
400	1.15	1.50	3.00
600	1.35	1.75	4.00

CD 110 LINEAR 256 XT BIT SELF SCANNING CHARGED COUPLED DEVICE \$99.00

LINEAR CIRCUITS

LM 309K 5V 1A REGULATOR	\$1.25
723 - 40 + 40VV REGULATOR	\$.50
301/748-HI Per. Op. Amp.	\$.31
320T 5, 12, 15, OR 24V NEGATIVE REG.	\$1.50
741 A or 741 C OP. AMP.	\$.31
710 COMPARATOR	\$.35
307 OP AMP	\$.31
CA 3047 HI Per. Op. Amp.	\$.95
340T 5, 6, 8, 12, 15, 18, 24V POS REG. TO-220	\$1.50
101 OPER. AMP. HI PERFORM.	\$.75
LM 308 Op. Amp. - Low Power	\$.95
347 - DUAL 741	\$.85
556 - DUAL TIMER	\$1.00
537 - PRECISION OP. AMP.	\$1.70
LM 3900 - QUAD OP. AMP.	\$.49
LM 324 - QUAD 741	\$1.50
560 - PHASE LOCK LOOP	\$2.00
561 - PHASE LOCK LOOP	\$2.00
565 - PHASE LOCK LOOP	\$1.25
566 FUNCTION GEN.	\$1.65
567 - TONE DECODER	\$1.50
LM 1310N FM STEREO DEMOD.	\$2.75
8038 IC VOLTAGE CONT. OSC.	\$3.90
LM 370 - AGC SQUELCH AMP.	\$1.15
555 - 2w - 2 HR. TIMER	\$.45
553 QUAD TIMER	\$2.50
FCD 810 OPTO-ISOLATOR	\$.80
1458 DUAL OP. AMP.	\$.60
LM 380 - 2W AUDIO AMP.	\$.95
LM 377 - 2W Stereo Audio Amp.	\$2.50
LM 381 - STEREO PREAMP	\$1.50
LM 382 - DUAL AUDIO PREAMP	\$1.50
LM 311 - HI PER. COMPARATOR	

THE KING OF ALTAJ

\$23.50



6-DIGIT ALARM CLOCK

THE KING FEATURES:

- 1) 6 digit, 12 hr, 60 cycle or 24 hr, 50 cycle alarm clock.
- 2) Time sharing capability for display of additional information.
- 3) Single 12v supply and a minimum of interface components.
- 4) AM PM and automatic power fail and indications.
- 5) 10 minute snooze.
- 6) Intensity control of LEDs.

Add 10% for Shipping
 Kit No. 70250 1R (Red readouts)
 Kit No. 70250 1G (Green readouts)
 Kit No. 70250 1Y (Yellow readouts)
 Kit No. 70250 2R (DL727 readouts) \$28.50
 Kit No. 70250 3R (FND807 readouts) \$28.50

All kits include components, PC Board, Transformer, Case, and construction manual.

THE KING'S HAREM

FATIMA 4-DIGIT TEMP. KIT

\$19.95



Features 4 digit temperature display, Fahrenheit or Centigrade, complete CMOS application uses 7007 & 4 digit counter.

Kit includes all components, PC Board and instructions for interfacing with THE KING 6-digit alarm clock. Additio. Number 1

DELILA APPLIANCE STARTER \$9.95

(Example) Set your alarm for 7 a.m., set timer for 15 min. At exactly 7 a.m., the appliance will start, at 7:15 your clock alarm will wake you.

Kit includes all components, PC Board and instructions for interfacing with THE KING 6-digit alarm clock. Additio. Number 2

TANYA 60 HZ CRYSTAL TIME BASE

ADDITIONAL FEATURES:

- 1) Low Power Consumption
- 2) Directly Interfacible with King MDS Clock Chip
- 3) 60 KHz output with crystal time base accuracy
- 4) Ideal for Cars, Boats, & Campers

\$5.95

Kit includes all components, PC Board and instructions for interfacing with THE KING 6-Digit Alarm Clock. Additio. Number 3



FND70
 RED, .25 In. Char.
 15mA per segment.
 Common Cathode
 \$1.25

DL727

One of our best readouts
 5 in. high, 20mA per
 segment, Common anode.
 \$3.75



FND807
 New .5 in. display
 by Fujitsu.
 Common Cathode.
 \$1.68
 \$57.50

FND807 ANODE
FND800 CATHODE

BURROUGHS
12 DIGIT

25 in high orange
 digit, 160v dc
 Free socket. \$2.50



TI
 Fully multi-seg. common cathode.
 Goldplate. Ideal for mind 6 digit
 clock. \$1.38

LEDS

- Mini red 12
- Jumbo red 15
- Jumbo green 20
- Jumbo yellow 25

DL33
 If you like an
 array of displays,
 we have it. Com-
 mon cathode. \$1.65

TTL BOARDS

MEMOREX computer boards with TTL's Diodes and Transistors, etc.

*5 Boards containing 150 250 IC's \$4.50

GE TRANSISTOR ASSORTMENT

TO18 Lead Device, SCRs, NPN, PNP, ect.

50 for \$1.50
 100 for \$2.50
 300 for \$6.00

LSI INTEGRATION

MM5336	4 6 digit alarm clock 40 pin dip w/epic.	\$ 4.25
7002	4 digit counter/latch decoder; 7 segment and BCD outputs. 28 pin dip w/epic.	\$12.50
7005	4 digit counter/latch decoder, 7 segment output only. 24 pin dip w/epic.	\$ 8.50
7007	4 digit counter/latch decoder with BCD output only. 16 pin dip w/epic.	\$ 7.00
70250	4 6 digit alarm clock 28 pin dip w/epic.	\$ 5.50
PC Board for 70250		\$ 4.75
70380	4 digit non multiplexed rapid alarm clock featuring direct drive display output 40 pin dip w/epic.	\$4.50
PC Board for 70380		\$ 3.75
8008	8 bit parallel CPU.	\$19.50
2102	16 static RAM for 8008	\$ 2.25
MM5203	2K UV erasable PROM.	\$12.25
75491	segment driver.	\$ 0.35
75492	digit driver.	\$ 0.45
7020	6 function calculator chip with direct segment drive. 8 digit.	\$ 2.25

TTL

CMOS

7400	21	7448	94	74151	80	4000	24	4018	149	4037	4 50
7402	21	7453	21	74153	94	4001	24	4019	59	4040	1 59
7404	21	7413	42	74154	100	4002	24	4020	1 59	4041	89
7406	29	7474	42	74161	1 04	4006	149	4021	149	4042	79
7408	21	7475	70	74163	1 24	4007	24	4022	1 49	4043	80
7410	21	7476	44	74164	1 94	4008	115	4023	24	4044	59
7413	54	7483	90	74165	1 44	4009	59	4024	99	4047	59
7420	21	7489	2 50	74175	1 44	4010	55	4025	24	4049	59
7427	29	7492	80	74177	1 34	4011	24	4027	59	4050	69
7430	21	7490	74	74181	2 80	4012	24	4028	99	4066	99
7437	44	7493	80	74192	1 30	4013	59	4029	1 39	74112	29
7438	39	7496	80	74193	1 30	4014	149	4030	49	74C04	29
7440	21	7495	80	74195	84	4015	119	4034	3 25	74C07	1 29
7442	74	74121	43			4016	59	4035	1 39		
7447	94	74123	80			4017	1 29				

4 & 6 DIGIT PC BOARDS

PC Board for 4 digit display FND800 or 807	\$2.75
PC Board for 6 digit display FND800 or 807	\$3.90
PC Board for 4 digit display MAX7 segments or DL707	\$1.75
PC Board for 6 digit display MAX7 segments or DL707	\$2.75
PC Board for 4 digit display FND503	\$2.00
PC Board for 6 digit display FND503	\$3.00
PC Board for 4 digit display DL727	\$2.16
PC Board for 6 digit display DL727	\$3.06
PC Board for 4 digit display DL727	\$2.25
PC Board for 6 digit display DL727	\$3.00
PC Board for 4 digit display FND10	\$1.75



MSI

Wise move



4-DIGIT DECADE COUNTER KIT

\$19.95

One chip 4 digit decade counter kit, with both 7 segment and BCD output.

1. Chip features internal oscillator for scanning speed.
2. Overflow and count reset output.
3. Transfer, reset, count, blanking and true complement control inputs.
4. PC Boards can be cascaded to 8 12 16 etc. digits.
5. Kit includes counter chip, drive circuit for 4 cathode type dip plays and PC Board. (For read out board see FND70 FND503)

MODULAR SCIENTIFIC INSTRUMENTATION

Now you can build some of the most advanced digital electronic instruments with our new series of low-cost modular scientific kits. These kits will expand the range of your electronic aspirations enormously and all at a surprisingly low cost. The heart of the system is our 4 digit Decade Counter (Kit 012) which features a full 4 digit LED readout (you choose the size best suited to your application). Combine this with a 5 volt regulated power supply (Kit 030) and you have the basis of a wide range of sophisticated electronic instruments, including:

- A Digital Voltmeter (DVM) Kit 012 • Kit 030 • Kit 017
- Frequency Counter..... Kit 012 • Kit 030 • Kit 016 • Time Base RPM Counter..... Kit 012 • Kit 030 • Kit 020 • Kit 018

KIT 016 FREQ. COUNTER

Features FET input front end with trigger circuit for measuring complex waveforms. Measures from 0.1Hz to 10MHz when used with Kit 015 or 019. Measures from 0.1Hz to 35MHz when used with Kit 013 and 014.



\$24.50

KIT 030 POWER SUPPLY

*Input voltage 25V max. *Output current 1 amp max. *Load regulation 50mV. *Output voltage 5V 1% regulation. *DIN. (requires 8 20V transformer)



\$4.95

KIT 017 DVM

1 999V in basic, with polarity indication. 1 M ohm input impedance and accuracy to 1% if properly adjusted



\$18.50

TIME BASES

1 Mhz crystal chain time base divider. Outputs: 1MHz-100KHz-10KHz-100Hz-10Hz-1Hz 0.1Hz. Accuracy better than .005% with proper adjustment.

Kit 013 complete CMOS with PC board..... \$15.75
 Buffer Circuit for TTL Interfacing

Kit 014 Same as Kit 013, but with TTL..... \$13.75

Kit 015 50Hz or 60Hz chain time base using line frequency as reference. Accuracy 0.1-0.05%. Outputs 10Hz-1Hz 0.1Hz. Complete with CMOS driving circuit and PC Board..... \$9.75

Kit 019 Same as Kit 015, but with TTL and 60Hz only..... \$7.75

Kit 018 60Hz chain time base using line frequency for Kit 020 RPM counter.

*Outputs: .5 sec - 100Hz of RPM
 6 sec - 10Hz of RPM
 60 sec - full revolution \$9.75



\$15.75



\$13.75

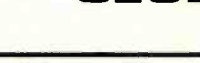

\$9.75



\$7.75

MSI CLUB

Send for your membership card to the Modular Scientific Instrumentation Club and receive a big 10% off on future purchases of MSI kits. Send \$3.00 with your name and address. We will promptly send you your very own registered membership card. Don't miss out on the savings Write now.

Memberships valid for one year from date of registration.

A-C-E 208 Part No. 923332

\$28.95

Add 10% for Shipping

Write for our FREE Brochure

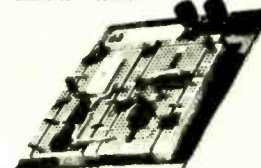

SAVE! 4-DIGIT ALARM CLOCK

Kit No. 1 \$13.95 (with PC Board)

FEATURES:

Direct drive display outputs. Current control regulation on chip. Low power brightness control on chip. RFI eliminating bypass circuitry. Sleep Radio feature. 24 hr snooze alarm. Independent local setting. Non multiplexed output circuitry. 12VAC CT 1 2 amp transformer for Kit No. 1 \$2.00

KIT NO. 2

Complete kit with components, PC Board, Transformer wood grain case and filter for display window. Includes 25 m readouts \$21.50

KIT NO. 3

Complete kit with components, PC Board, Transformer wood grain case and filter for display window. Includes 5 mm readouts \$22.50

*Components for Kit No. 2 or Kit No. 3 sleep radio feature, add \$9.50 Add 10% for Shipping



LIGHTS MUSIC 60 WATT COLOR ORGAN

Completely self contained unit with 120 volt power cord included \$2.00



LINEARS

- 555 Timer Mini dip 0.65
- 8038 Functional generator 4.25
- RCA 3043 1M Hz. Aud Preamp. 1.20
- 565 Phase Lock Loop 1.95
- 567V Tone Decoder 1.50
- LM723 Pos. Volt. Reg. 0.55
- LM309 5v. Lamp Reg. 1.10
- LM380 2w. Audio Amp. 8 pin dip 1.00
- LM741 Operational Amp. 0.25

TRANSISTORS-DIODES

- RCA200V 115W TO5 NPN 1.25
- GE D40C1 NPN Dar 0.25
- 2N4435CR 400MA TO220 0.65
- 2N2222 NPN Gen Amp 0.20
- 2N3904 NPN Driver 0.15
- 2N3906 PNP Compl. 2N3904 0.15
- 2N4300 NPN Low level noise 0.20
- 2N5401 PNP Noise driver 0.25
- 1N4004 400PV 15 for 1.00
- 1N4007 400PV 10 for 1.00
- 1N746 3.3 Zen 4 for 1.00
- 1N4748 Switch 20 for 1.00

LOOK!

From Altaj (10% off) up to 80%
 Power Supply Kit 5 Volt 1 Amp. Reg. Line regulation .005% Load regulation 50mV
 Kit includes Components, PC Board, Transf., Fuse, Pilot Light
 Nothing else to buy \$6.50

Poly Pak's EXCLUSIVE Avg. Ship. \$1.98 Wt. 6 ozs.



100% MATERIAL TOO!

100'S OF BARRELS PURCHASED! TEST 'EM YOURSELF 'N SAVE!

For the first time anywhere, Poly Pak merchandisers introduce a new way in buying the economical way. Raw stock from the "barrel". Remember the "good ole days"? They're back again. The same way merchandisers throughout the United States buy from various factories... their overruns in barrels. Poly Pak has done the same. Therefore you are getting the same type of material as the RE-TESTERS DO!

YOUR CHOICE OF ANY KIT

Every kit carries a money back guarantee!

<p>BARREL KIT #1 SN7400 DIP IC'S 75 for \$1.98</p> <p>Marked 14 and/or with 16 pin dips, may include gates, registers, flip flops, counters. Who knows? GUARANTEED SATISFACTION! Cat.No. 9R2415 Untested.</p>	<p>BARREL KIT #2 LINEAR OP AMPS. DIPS 75 for \$1.98</p> <p>Un- tested \$1.98</p> <p>May include 709's, 741's, 703's, 660 series. 665 includes marked and unmarked. Cat.No. 9R2416</p>	<p>BARREL KIT #3 1N4148/914 SWITCHING DIODES 100 for \$1.98</p> <p>You never saw this before. Imagine famous switching diodes at this price! Cat.No. 9R2418 Untested.</p>	<p>BARREL KIT #4 "4000" RECTIFIERS 100 for \$1.98</p> <p>Un- tested.</p> <p>These are the famous micro miniature rectifiers of the 1N100B series. May include 25, 50, 100, 200, 400, 600, 800 and 1000 volters. Cat.No. 9R2417</p>	<p>BARREL KIT #5 SCRS, TRIACS, QUADRACS 40 for \$1.98</p> <p>All the famous plastic power tab type. Raw factory stock! All the 10 amp types. Cat.No. 9R2419 Untested.</p>	<p>BARREL KIT #145 MINI TRANSFORMER 15 for \$1.98</p> <p>Miniature transformer back again. Aast. outputs, interstage and audio. Only 1" sq. Wt. 2 lbs. 9R3294</p>	<p>BARREL KIT #147 OVER-FLO FLUORESCENT MIXIES 5 for \$1.98</p> <p>Used originally in table top calculators. Brand new. Gas discharge type, color! Blue. Cat. No. 9R3288</p>	<p>BARREL KIT #151 INCANDESCENT CLOCK CHIPS 20 for \$1.98</p> <p>Importer sez, "Name your price". Hard to find 7-seg. 8V readouts. How good, aast sizes, we don't know. Can't test 'em. 9R3305</p>	<p>BARREL KIT #155 MOLDED CAPACITORS 75 for \$1.98</p> <p>Aast. size voltages, red, green, yellow, blue plastic cases, axial leads. No. 9R3311</p>	<p>BARREL KIT #159 MODULAR SWITCHES 24 for \$1.98</p> <p>Centralab "push-ON" switches. TV-makers ex-cases. Updt. epdt. etc. Brand new. Cat. No. 9R3150</p>	<p>BARREL KIT #160 V. REGULATORS 15 for \$1.98</p> <p>LM309KC TO-3 V.R.'s barreled. Bot by the pound. But who wants to do am? Your gain. No. 9R3330</p>	<p>BARREL KIT #161 "POP" PLASTIC TRANSISTORS 25 for \$1.98</p> <p>Calculator maker dumps 2N3904's with the famous 2N3906's of 100% material. TO-92. Preformed. Cat. No. 9R3343</p>	<p>BARREL KIT #7 VOLUME CONTROL BONANZAI! 40 for \$1.98</p> <p>100% good Singles, duals, variety of values, styles, big ones — small ones. Cat.No. 9R2421</p>	<p>BARREL KIT #8 SUBMINIATURE IF TRANSFORMERS 100 for \$1.98</p> <p>100% good. Amazing, includes 45Kcs, etc, antenna, who knows? From transistor radio manufacturers. Cat.No. 9R2422</p>	<p>BARREL KIT #10 ROMS-REGISTERS 50 for \$1.98</p> <p>Un- tested</p> <p>28 to 40 pin devices, marked internal factory numbers. rto Cat.No. 9R2424</p>	<p>BARREL KIT #12 POWER TAB TRANSISTORS 40 for \$1.98</p> <p>PNP. plastic TO220 type. Assorted 2N numbers. Cat.No. 9R2426 Untested.</p>	<p>BARREL KIT #13 RESISTOR NETWORKS 60 for \$1.98</p> <p>Un- tested.</p> <p>By Corning Glass, in 14-pin dib paks. Cat.No. 9R2427</p>	<p>BARREL KIT #14 PRECISION RESISTORS 200 for \$1.98</p> <p>Marked and unmarked 1/4, 1/2, 2 watts. No. 9R2428</p>	<p>BARREL KIT #15 MOSFET TRANSISTORS 60 for \$1.98</p> <p>All 4 leaders TO-18 case. Includes UHP transistors too! Cat.No. 9R2429</p>	<p>BARREL KIT #17 LINEAR & 7400 DIPS 100 for \$1.98</p> <p>Un- tested</p> <p>Marked and unmarked, internal numbers of raw factory stock. Cat.No. 9R2431</p>	<p>BARREL KIT #18 DIPPEL MYLARS 60 for \$1.98</p> <p>Finest capacitor made. shily finish. Imagine factory dumping 'em in barrels. Cat.No. 9R2597 100% good.</p>	<p>BARREL KIT #20 LONG LEAD DISCS 150 for \$1.98</p> <p>Factory distributor stock "auction sale". Prime, marked only. Long leads. Cat.No. 9R2598 100% good.</p>	<p>BARREL KIT #25 METAL CAN TRANSISTORS 100 for \$1.98</p> <p>Un- tested.</p> <p>Includes TO-5, TO-1, TO-18, etc., assorted 2N numbers, unmarked etc. Cat.No. 9R2603</p>	<p>BARREL KIT #26 PLASTIC TRANSISTORS 100 for \$1.98</p> <p>Un- tested.</p> <p>Type TO-92 (TO-18), all manufacturers, variety of 2N's. Cat.No. 9R2604</p>	<p>BARREL KIT #30 PREFORMED RESISTORS 250 for \$1.98</p> <p>We got barrels of 1/2 and 1/4 watters for pc use. You'll get even amount. 100%, 100% 100% watters. Cat.No. 9R2608 100% good</p>	<p>BARREL KIT #31 METALLIC RESISTORS 100 for \$1.98</p> <p>Made mostly by Corning, the finest resistor made. Mostly 1/2 watters, 1% to 5% tol. & a barrel of values. Cat.No. 9R2609</p>	<p>BARREL KIT #32 TRANSISTORS WITH A HOLE IN IT 50 for \$1.98</p> <p>Un- tested.</p> <p>Can't name factory but we bought barrels of 25 watters with mtg. hole in middle. PNP'S and NPN'S.</p>	<p>BARREL KIT #33 NEON LAMPS 30 for \$1.98</p> <p>100% good. Famous NE-2's. All prime, but factory made millions and barreled 'em. Not advantage. Cat.No. 9R2613</p>	<p>BARREL KIT #36 GERMANIUM DIODES 200 for \$1.98</p> <p>Un- tested</p> <p>Famous maker, popular item. Never grows old. But this is the way the RE-TESTERS buy 'em from the factories. Cat.No. 9R2614</p>	<p>BARREL KIT #37 "BULLET" RECTIFIERS 100 for \$1.98</p> <p>Un- tested.</p> <p>Famous style, aast. voltages, silicon, axial includes wide asst voltages to 1KV. Cat.No. 9R2615</p>	<p>BARREL KIT #38 MOBBY TRANSISTORS 15 for \$1.98</p> <p>100% good. From factory to you, these fellows of the famous 2N3055. We have 10 barrels. Cat.No. 9R2617</p>	<p>BARREL KIT #40 PNP HIGH-POWER TRANSISTORS 20 for \$1.98</p> <p>Popular germanium TO-3 case units, now available at "good ole barrel" prices. Cat.No. 9R2618 100% good.</p>	<p>BARREL KIT #46 G.E. 3.5 WATT AMPLIFIERS 25 for \$1.98</p> <p>Un- tested.</p> <p>Hobby type, factory failures, we purchased them in barrels. These are unknown. Cat.No. 9R2624</p>	<p>BARREL KIT #50 SIGNAL SILICON DIODES 200 for \$1.98</p> <p>Includes many, many types of switching, signal silicon types, all axial leads. Some may be zeners. Cat.No. 9R2628 Untested.</p>	<p>BARREL KIT #53 JUMBO RESISTOR PAK 100-pc. \$1.98</p> <p>Un- tested.</p> <p>Assortm metal films, precision, carbons, metal oxide powers, from 1/2 watt to 7 watts. Color coded & 100% good. Worth \$10.</p>	<p>BARREL KIT #58 8 DIGIT READOUTS 7 for \$1.98</p> <p>Bargain of a lifetime! All we got was 1 barrel — the "blisidor digit" types. Multi-plexed. Cat. No. 9R2722</p>	<p>BARREL KIT #59 SLIDE SWITCHES 30 for \$1.98</p> <p>All shapes, sizes, spst, apdt, momentaries, etc. Technician shop pak for 100's of switching projects. Cat.No. 9R2726 100% good.</p>	<p>BARREL KIT #61 POLYSTYRENE CAPS 100 for \$1.98</p> <p>Un- tested.</p> <p>Factory returns — such numbers as MAN-3's, MAN-7's, MAN-9's, 11 barrels & no time to separate. Cat.No. 9R2729 Untested.</p>	<p>BARREL KIT #65 MIXED READOUTS 15 for \$1.98</p> <p>Un- tested.</p> <p>Factory returns — such numbers as MAN-3's, MAN-7's, MAN-9's, 11 barrels & no time to separate. Cat.No. 9R2733 Untested.</p>	<p>BARREL KIT #66 2 WATTERS 100 for \$1.98</p> <p>100% good. Nobody seems to want 'em! So many suppliers don't count, but throw 'em in the barrel. It's a 1/2 good mix! All marked. Cat.No. 9R2735</p>	<p>BARREL KIT #71 CAPACITOR SPECIAL 100 pcs. \$1.98</p> <p>Un- tested.</p> <p>Emptied stockrooms into barrels of mylars, poly'a, mica, malded, plastics, ceramics, discs, etc. Nifty. 100% good. Cat.No. 9R2738</p>	<p>BARREL KIT #73 TRANSISTOR ELECTROS 50 for \$1.98</p> <p>Un- tested.</p> <p>It "bugs" us why the factories dump 'em in barrels. We don't wish to separate wide asst voltages & values up to 300 mf. Cat.No. 9R2747</p>	<p>BARREL KIT #75 400MW ZENERS 150 for \$1.98</p> <p>Un- tested.</p> <p>Factory out of biz! Amazing offer: 6, 8, 10, 12 to 10V. You test. Hermetically sealed & 100% good. Double plug. Cat.No. 9R2740</p>	<p>BARREL KIT #76 1-WATT ZENERS 100 for \$1.98</p> <p>Un- tested.</p> <p>Factory same as 400-mw's. Never-to-see-again offer, 6, 8, 10, 12, 15V. under glass. Double plug. Cat.No. 9R2741</p>	<p>BARREL KIT #77 "BROWN" BODY TRANSISTORS 40 for \$1.98</p> <p>Un- tested.</p> <p>G-E D-10 series: has bi-voltage, Darlington, hi-current, npn's. Factory line discontinued. Power tabs. Cat.No. 9R2742 Untested.</p>	<p>BARREL KIT #81 SUBMINI RESISTORS 200 for \$1.98</p> <p>100% good. PC, upright type, color coded, 1/2 watt. Aast values. Came to us in a barrel. Cat.No. 9R2746</p>	<p>BARREL KIT #83 LM-340T VOLTAGE REGULATORS 15 for \$1.98</p> <p>Un- tested.</p> <p>Factory rejected them for length of leads. May include 5, 6, 8, 12, 15, 18, 24 volt. Power tab Cat.No. 9R2633</p>	<p>BARREL KIT #86 MOBBY LEDS 40 for \$1.98</p> <p>Un- tested.</p> <p>Wow! A Litronics dump of all kinds of mixed discrete LEDS, shapes, colors, good, poor, etc. 9R2859</p>	<p>BARREL KIT #87 NATIONAL IC BONANZALITRONICS LED READOUTS 100 for \$1.98</p> <p>Un- tested.</p> <p>Factory dumps into barrels. Types 8009, 7440 series, DTLA, ROMA, registers, clock & calc. chips, linear, etc. Cat.No. 9R2860 Untested.</p>	<p>BARREL KIT #88 TO-3 PLASTIC TRANSISTORS 40 for \$1.98</p> <p>Un- tested.</p> <p>1-Million pcs of 100%, 60K mini pots, ceramic case, long shaft. Supt maker unloads. 9R3058</p>	<p>BARREL KIT #89 MOT ELECTRIC CELLS 10 for \$1.98</p> <p>Un- tested.</p> <p>Aast. GE types, CDS types. Mixed by factory. Big job for us to separate. 100% food. Cat.No. 9R3052</p>	<p>BARREL KIT #101 RESISTOR SPECIAL 200 for \$1.98</p> <p>Un- tested.</p> <p>Includes: 1/4, 1/2, 1/2, 1, 2-watters, carbon. 100% good. 9R3055</p>	<p>BARREL KIT #104 SLIDE VOLUME CONTROLS 10 for \$1.98</p> <p>Un- tested.</p> <p>Used in hi-volume control mixer unloads. Aast. values, what a buy! Worth \$1 ea. We've got barrels of 100% material. 9R3057</p>	<p>BARREL KIT #108 MINI VOLUME CONTROLS 25 for \$1.98</p> <p>Un- tested.</p> <p>1-Million pcs of 100%, 60K mini pots, ceramic case, long shaft. Supt maker unloads. 9R3058</p>	<p>BARREL KIT #110 NATIONAL IC BONANZALITRONICS LED READOUTS 100 for \$1.98</p> <p>Un- tested.</p> <p>Factory dumps into barrels. Types 8009, 7440 series, DTLA, ROMA, registers, clock & calc. chips, linear, etc. Cat.No. 9R2860 Untested.</p>	<p>BARREL KIT #111 MINI SCRS 50 for \$1.98</p> <p>Un- tested.</p> <p>UNBELIEVABLE! TO-92 plastic SCRS in barrels — rite from factory. Includes all voltages up thru 200 prv. 9R3136</p>	<p>BARREL KIT #112 MICRO MINI LEDS 40 for \$1.98</p> <p>Un- tested.</p> <p>All the tiny leds, axial, upright of Monsanto, Litronics, variety of colors. Yield 80% or better. Cat.No. 9R3139</p>	<p>BARREL KIT #115 MOLEX SOCKETS 200 for \$1.98</p> <p>100% good. Calculator maker dumps! We got a zillion of 'em. Used for IC sockets, etc. Cat.No. 9R3144</p>	<p>BARREL KIT #116 BUTTONS 'N FEEDTHRU'S 100 for \$1.98</p> <p>100% good. Truthfully worth a button-forthru! Wide asst. of button-feedthru caps! HAMS TAKE NOTE! RF, UHP, etc. Wt. 1 lb. Cat.No. 9R3141</p>	<p>BARREL KIT #118 MINI SCRS 50 for \$1.98</p> <p>Un- tested.</p> <p>Deliberately thrown in barrels, so we can't test 'em! The famous CD-400 series. How good? Who knows? Who cares? It's only 30 ea. Cat. No. 9R3257</p>	<p>BARREL KIT #119 PRECISION RESISTORS 100 for \$1.98</p> <p>Un- tested.</p> <p>100% good. 2 ozt. PREFORMED! Designed for preformed circuit work. 1/2 watt. Marked values, 1 and 2% values. 9R3205</p>	<p>BARREL KIT #123 CALCULATOR CHIPS 15 for \$1.98</p> <p>Un- tested.</p> <p>National type. MMS736, 38, etc. They have discontinued these chips. FIND A USE. Un- tested. Cat. No. 9R3258</p>	<p>BARREL KIT #126 UPRIGHT ELECTROS 40 for \$1.98</p> <p>Un- tested.</p> <p>Wide asst. of values from 1mf to 300mf in mixture of voltages. 100% marked 'n good. Why barreled? U-got-n-buy! Cat. No. 9R3226</p>	<p>BARREL KIT #133 CLIP IN DIODES 50 for \$1.98</p> <p>Un- tested.</p> <p>100% good. 2 ozt. Snaps into fuse type clip holder. 1N42 diodes. Metal ferrule type. No. 9R3241</p>	<p>BARREL KIT #138 PANEL SWITCHES 30 for \$1.98</p> <p>Un- tested.</p> <p>Did you hear of OAK? Another eqpt maker barreled all types of rotaries, electric, slides, etc. 9R3268</p>	<p>BARREL KIT #142 DARLINGTON TRANSISTORS 40 for \$1.98</p> <p>Un- tested.</p> <p>TO-92, a Motorola dump, unknown numbers, but high yield to good darlington. Retesters don't get 'em! You will! 3285</p>	<p>BARREL KIT #143 75-PC TRANSISTORS 100 for \$1.98</p> <p>Un- tested.</p> <p>100% material, TO-92, factory discontinued lines, npn's mixed with npn's. 2N4400-1-2-3-4. Wut do you care. It's gud stuff. Cat.No. 9R3290</p>	<p>BARREL KIT #144 RCA PHONO PLUGS 40 for \$1.98</p> <p>Un- tested.</p> <p>1,000,000 RCA phono plugs for this one. You hi-ers know wut they are — 100% material. Look at the price. 9R3293</p>	<p>BARREL KIT #150 TERMINAL STRIPS 150 for \$1.98</p> <p>Un- tested.</p> <p>Wide asst. of terminal strip connectors, from 1 contact up. Strip manufacturers barrel dump in your gub, Wt. 1 lb. Cat.No. 9R3136</p>	<p>BARREL KIT #121 AXIAL ELECTROS 40 for \$1.98</p> <p>Un- tested.</p> <p>Truthfully the factories (by mixing 'em in barrels) do all of us a favor, WUT A BIZ! Aast. capacities and voltages. Cat. No. 9R3227</p>	<p>BARREL KIT #137 OPTO SPECIAL 25 for \$1.98</p> <p>Un- tested.</p> <p>"Skinny C-Thru's". New, Monsanto, infra-red led, photo darlington, photo transistors. 9R3262</p>
---	--	---	--	---	---	--	--	--	--	---	--	---	--	---	---	--	---	--	---	---	---	--	---	---	---	---	--	---	--	---	---	--	---	---	---	---	---	--	--	---	--	--	--	--	---	--	---	---	---	---	---	--	--	--	---	---	---	---	---	--	---	--	---	---	---	---	--	---	---	--

Terms: Add postage. Rated: net 30
Phone: Wakefield, Mass. (617) 245-3829
Retail: 16-18 Del Carmine St., Wakefield.
MINIMUM ORDER — \$6.00

POLY PAKS
P.O. BOX 942R LYNNFIELD, MASS. 01940

C.O.D.'s MAY BE PHONED
Send for FREE Fall-Winter CATALOG

Olson electronics

Parts and Accessories



	REG.	SALE
5-Pc. SCR Kit	TR-298	1.79 1.00
500 Mw Zeners (5 Asstd)	DI-052	.99 .50
Unijunction Transistors (Pkg. 3)	TR-441	1.29 .50
Red L.E.D.s. Lg. (Pkg. 5)	PL-233	1.19 .60
9 Digit Sperry Display	XM-399	1.00 .60
20 Key Calculator Keyboard	XM-339	2.49 1.40
Tl 20 Key Cal. Keyboard	XM-523	5.00 1.60
Ultra-Mini Red L.E.D.s (Pkg. 5)	PL-289	1.29 .70
3" 7-Seg. L.E.D. Display	XM-512	1.70 .70
60 CFM Exhaust Fan	MD-390	5.00 2.50
Metal TV Cart	XM-375	2.49 .99
2 Volt Wet-Cell Battery	BA-329	6.95 3.00
CB Rules Book with License	BK-292	1.00 .30
Set of 4 Easy-Roll Casters	XM-111	.69 .49
"Mini" Nixie Tube	XM-107	1.69 1.00
5# Surprise Kit	XX-196	3.29 1.00
Solder Lugs (Pkg. 13 Asstd)	XM-004	1.49 .80
Digital Clock Kit	XM-511	19.00 11.00
3 1/2 Digit L-C Display	XM-371	10.00 4.50
LM 309K 5V Regulator	TR-511	1.60 1.10
CB Carrying Case	CB-557	13.95 9.00
Disappearing CB Ant. Mount	AA-010	11.95 8.00
8" 2-Way Wood Speaker System	SS-080	20.00 12.00
Hi-Fi Stereo Headphones	PH-331	7.00 3.50
FM-Converter For Auto Radio	AU-333	22.00 15.00
CB Hump Mount	CB-558	4.95 3.00
Trunk Mount CB Antenna	AA-999	15.00 9.00
CB Converter for Auto Radio	CB-417	17.00 11.00
Ni-Cad Battery AA Size (Pkg. 3)	BA-327	3.50 1.50
1.2 Volt Ni-Cad Battery	BA-328	6.00 3.00
8 Tr. Tape Recorder Head	HF-283	5.00 2.50
3 1/4" 8 ohm Speaker	SS-114	.95 .50
117 VAC Black Light Bulb	XM-291	1.00 .50
Window Lock Alarm	XM-112	.88 .70
117 VAC Heavy-Duty Solenoid	SW-839	1.79 1.00
Assorted Knob Kit (25 Pc)	KN-030	1.00 .50
100 Ceramic Capacitors	CC-210	1.29 1.00
1/30 RPM Timing Motor 117 VAC	MO-359	.89 .50
5# Hardware Kit	HW-181	2.00 1.20
Post 10" Slide Rule	TL-582	1.49 1.00
Water Temp. Thermometer (Pkg. 2)	XM-495	1.49 .60
709 IC OP Amp.	RE-131	1.49 .90
Cadmium Photocells (Pkg. 2)	TR-514	1.00 .50
Miniature 12 VDC Solenoid	SW-836	1.19 .70
Magnetic Reed Switch (Pkg. 5)	SW-807	1.00 .70
Low Voltage Elect. Capacitor (50 Asstd)	CD-407	5.00 2.70
117 VAC/DC 4000 RPM Motor	MD-395	2.98 1.50
Audio Output Xfmr. 2500 to 4/8 ohms	TT-092	1.09 .70

ADD POSTAGE & SALES TAX

FREE 8 Olson Catalogs
FREE Olson CB Catalog
 NEXT 8 ISSUES SENT TO YOU FREE
 WITH DEALERS PRICE LIST

Olson Electronics, 260 S. Forge St., Dept. LP, Akron, Ohio 44327
 Please send me Olson catalog CB catalog Both . Please Print

NAME _____
 ADDRESS _____
 CITY _____
 STATE _____ ZIP _____

ADVERTISING INDEX

RADIO-ELECTRONICS does not assume any responsibility for errors that may appear in the index below.

READER SERVICE CARD NO.	PAGE
86	Allison Automotive Co.110
51	American Technology Corp.114
1	Amperex Electronics Corp.17
96	Antenna, Inc.121
39,40,41,42	Antenna Specialists Co. 89,91,93,95
2	AP Products112
	Audio Technica U.S., Inc.91
90	Avanti Research & Development, Inc.96
	Benwill Publishing Corp.23
99	B & K-Division of Dynascan Corp.35
68	Blonder-Tongue Cover III
37	Brooks Radio & TV Corp.115
98	Castle TV Tuner Service121
3	Channellock30
38	Chemtronics120
	CIE, Cleveland Institute of Electronics 104-107
4	Cobra-Division of Dynascan Corp. Cover IV
83,84	Continental Specialties Corp. 99,108
	CREI-Division of McGraw-Hill Continuing Education 52-55
43	Crown International16
49	Delta Products113
33	Edlie Electronics92
6,5	Edmund Scientific 100,138
64	EICO-Electronic Instrument Co.82
	E & L Instrument Co.32
	EMC-Electronic Measurement Corp.119
48	ETI-Electronics Technical Institute-Division of Technical Home Study Schools25
7	Fidelity Sound110
9	Florida Institute of Technology94
50	GBC Closed Circuit TV Corp.120
11	Grantham School of Electronics117
35,36	GTE Sylvania-Consumer Renewal 2,103
52	Handic of U.S.A., Inc.24
12	Harwil Co.93
100	Heath Co.18-21
30	Hickok Electrical Instruments Co.87
78	Hufco Labs Inc.114
	IMS Associates, Inc.22
13	Indiana Home Study Institute115
85	International Crystal Mfg. Co.118
15	Jensen Tools110
53,54	Jerrold Electronics Co. 109,113
16	Lafayette Radio Electronics Corp.83
65	Leader Instrument Corp.108
47	MITS-Micro Instrumentation Telemetry Systems, Inc.1
17	Mountain West Alarm Supply Co.102
18	National Camera Supply Corp.102
	National Radio Institute (NRI)-Division of McGraw-Hill Continuing Education Center8-11
	National Technical Schools 70-73
26	PAIA Electronics, Inc.95
27	Panavise, Division of Colbert Industries119
45	Perma-Power34
76	Processor Technology Corp.26
44	PTS Electronics, Inc. Cover II

READER SERVICE CARD NO.	PAGE
	Radio Shack31
59,57,58	RCA Distributor & Special Products 14,28-29,100
72	Royce Electronics15
67	Rye Industries116
91	Sansui Electronics Corp.33
25	Scelbi Computer Consulting Corp.111
81	Schober Organ Corp.93
71	Shure Brothers97
92	Southwest Technical Products37
89	Sphere Corp.102
24	Tab Books13
101	Tektronix, Inc.90
61,60	Telenatic Division, UXL Corp. ... 27,36
23	Tri-Star Corp.95
22	Tuner Service Corp.5
32	Vaco Products Co.7
80	Veras Systems, Div. of Solid State Sales98
21	Wahl Clipper Corp.112
69	Weston Instruments, Inc.101
94	Wilson Electronics Corp. 38-39
MARKET CENTER	
	Ace Electronic Paris132
46	Altaj134
70	American Used Computer Co.128
	Babylon Electronics132
	Karel Barta122
	CFR Associates122
	Consumertronics, Co.122
	Command Productions122
	Cornell Electronics Co.124
	Dage Scientific Instrument132
55	Delta Electronics129
	Devtronix Organ Products133
97	Digi-Key124
	Electronic Tool Co.128
63	Fordham Radio Supply Co.128
10	Formula International, Inc.123
31	Bill Godbout Electronics Unlimited128
56	Graymark Enterprises132
29	Hobb-y-tronix, Inc.128
	Information Unlimited124
14	International Electronics Unlimited125
88	Jade Co.137
74,75	James Electronics 130,131
	Lab Science124
	Lakeside Industries122
93	Stanley Lin Corp.133
66	Meshna Electronics, John Jr.124
62	New-Tone Electronics129
19	Nexus Trading Co.124
20	Olson Electronics Corp.136
	PTI132
28,34	Poly Paks133,135
77	Quest129
	Saxitone Tape Sales132
82	S. D. Sales Co.126,127
79	Solid State Sales133
95	Tracy Design Corp.122
	Trintronics Limited132
	Trumbull128
	Valley West122
	Visulex122

RADIO-ELECTRONICS

Circle 20 on reader service card

SPECIAL OF THE MONTH

TRANSISTORS

2N3906 MOT 12/1.00
100/7.00

SWITCHING DIODES

1N4148
Switching Diodes
20/1.00 100/4.00

DIODES

1N4007
12/1.00 100/6.50
1 Watt 5% Zeners
1N4728 to 1N4757 series
5/1.00 100/15.00
State Voltage — 3.3V to 51V

SWITCHES

DPDT Slide 5/1.00 25/4.00
V3-101-D8 10A 125V Micro 2/1.75
311SM56 10A 125V Micro 2/1.50

ASSORTMENT

10 different switches 1.00

SMOKE DETECTOR KIT \$29.95

C MOS

Part No.	Value	Price
34001	FSC	1.00
4000		4/1.00
4001		4/1.00
4002		4/1.00
4006		1.50
4007		4/1.00
4008		1.00
4009		2/1.25
4010		2/1.25
4011		3/1.00
4012		3/1.00
4013		2/1.00
4014		1.25
4015		1.50
4016		2/1.25
4017		1.25
4018		1.25
4019		2/1.25
4020		1.25
4021		1.50
4022		1.25
4023		3/1.00
4024		1.00
4025		3/1.00
4027		2/1.25
4028		1.25
4029		1.35
4030		2/1.25
4032		2/1.00
4033		2.00
4035		1.85
4040		2.45
4041		1.25
4042		1.25
4043		1.25
4044		1.25
4049		2/1.35
4050		2/1.35
4051		1.50
4052		1.50
4053		1.50
4060		3.00
4066		1.25
4069		3/1.00
4070		1.35
4071		2/1.00
4077		1.00
4081		2/1.50
4511		1.75
4512		1.75
4518		1.50
4520		1.65
4528		1.50

CrownTec L.E.D. watches



6-Function, 1-Button Solid State. Hours, Minutes, Seconds, Day of Week, Month & Day. The CrownTec L.E.D. watch contains the finest custom designed quartz crystal to assure accuracy of 3 min. per year. Guaranteed 1 yr. from date of purchase (battery excepted).

From 29.95 up

Illustrated:
Men's Rhodium with
Leather Band \$29.95
Ladies \$39.95

Other styles available in gold tone as well as Rhodium finish.

LINEAR CIRCUITS

Package Codes

H-TO5 K-TO3 M-8 PinMin N-14 PinDip T-TO220

304H	Neg Reg	1.00	566H	V Cont OSC	1.50
305H	V Reg	1.00	566N(8)	V Cont OSC	1.50
306H	V Comp	2.25	567N(8)	Tone Decoder	1.50
307H	OpAmp	3/1.00	702H		1.00
307N(8)	OpAmp	3/1.00	703H	RF/IF Amp	2/1.00
308H	OpAmp	1.00	709H(14)	OpAmp	3/1.00
308N(8)	OpAmp	1.00	710H	V Comp	2/1.25
309H		1.10	710N(14)	V Comp	2/1.25
309K	5V Reg	1.25	711H	Dual Comp	2/1.00
310H	V Fol	1.15	711N(14)	Dual Comp	2/1.00
310N(8)	V Fol	1.15	723H	V Reg	2/1.00
311H	V Comp	1.00	723N(14)	V Reg	2/1.10
311N(14)	V Comp	1.00	725H	Instr OpAmp	2.00
318H	HiPerOpAmp	2.00	733H	Dif Vid Amp	1.00
318N(8)	HiPerOpAmp	1.50	733N(14)	Dif Vid Amp	1.00
320T-5V	Neg Reg	1.75	739N(14)	Dual Aud PreAmp	1.00
320T-6V	Neg Reg	1.75	740H	FET OpAmp	7.00
320T-8V	Neg Reg	1.75	741H	OpAmp	3/1.00
320T-12V	Neg Reg	1.75	741H(8)	OpAmp	3/1.00
320T-15V	Neg Reg	1.75	741N(14)	OpAmp	3/1.00
320T-18V	Neg Reg	1.75	747H	Dual OpAmp	2/1.50
323K-5V	Reg	6.00	747N(14)	Dual OpAmp	2/1.50
339N(14)	LoV Quad Comp	1.80	748H	OpAmp	3/1.25
340K-5	Pos Reg	1.95	748N(14)	OpAmp	3/1.25
340T-5V	Pos Reg	1.75	749N(14)	OpAmp	1.50
340T-8V	Pos Reg	1.75	760N(14)	Dif Vol Comp	4.25
340T-12V	Pos Reg	1.75	1303N(14)	DI Ster PreAmp	1.00
340T-15V	Pos Reg	1.75	1414N(14)	Dual Dif Comp	1.75
340T-18V	Pos Reg	1.75	1458N(8)	Dual OpAmp	2/1.00
370H	AGC/SgAmp	1.15	1488N(14)	Quad MDTL Dr	2.00
370N(14)	AGC/SgAmp	1.15	1489N(14)	Quad MDTL Dr	2.00
373N(14)	AM/FM IF Det	3.25	1496N(14)	Mod-DeMod	1.00
380N(8)	Audio Amp	1.00	2900N(14)	Quad Amp	1.00
380N(14)	Audio Amp	1.25	3065N(14)	TV Snd Sys	2/1.50
381N(14)	Dual PreAmp	1.50	3900N(14)	Quad Amp	2/1.25
531H	OpAmp	3.00	3905N(14)	Prec Timer	2/1.25
550N(14)	Prec V Reg	1.00	3909N(14)		1.25
555N(8)	Timer	2/1.00	4136N(14)	Quad 741	1.75
556N(14)	Dual Timer	1.35	4558N(14)	Dual 741	2/1.00
565N(14)	Ph Lock Loop	2.00			

VIDEO GAME KIT 5IVE Games To Play

A CHALLENGE TO BUILD,
A CHALLENGE TO PLAY.

Features:

1. Basic Tennis games in three variations.
2. Plus 2 variations of Wipe Out the squares. A fascinating game for 1 or 2 players. Not available in most games sold.
3. All 5 games in one kit.
4. Curve Button for added excitement.
5. On screen scoring between plays.
6. Sound.
7. Basic TTL circuitry except for VK-6 proms.
8. Requires 5V DC + at 1/2A.

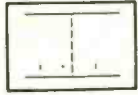

VK-1	PC Board Only Includes parts list & wiring Diagram requires VK-6	25.00
VK-2	PC Board with parts Includes PC Board, 78 IC's (those necessary are pre- programmed) resistors & capa- citors to stuff the board.	125.00
VK-3	Hardware Kit Controls, switches, wire Does not include Housing.	17.50
VK-4	RF Module Kit To convert video signal to TV receiver signal. Elimina- tes internal "wire in" on TV set.	22.50
VK-4-A	Antenna-Game Switch Allows outside antenna to remain connected while game is in use.	9.50
VK-5	Power Supply Kit For VK-1 or VK-2 PC Board ONLY.	12.50
VK-6	PROM Set 3 Programmed DM8574N with 2 DM8130N for VK-1 (If you have plenty of TTL).	50.00

IC SOCKETS

	LoPro	Standard	Wire Wrap
8	5/1.00	—	—
10	—	4/1.00	—
14	4/1.00	4/1.25	3/1.00
16	4/1.25	3/1.00	3/1.25
18	4/1.25	—	—
24	3/1.00	3/1.25	2/1.50
28	—	3/1.12	2/1.50

EDGE CONNECTORS

22 Pin dual Read Out	.156	2.25
50 Pin dual Read Out	.125	5.00

LED'S

TIL312	0.3 ChHt	1.00
MAN4	0.187 ChHt	2/1.00
TIL308	0.27 ChH with built in logic	4.00

JADE Co

ELECTRONICS DISTRIBUTION

2007 W. CARSON (213) 320-1250
P.O. BOX 4246 TORRANCE, CA. 90510

TERMS:

\$1 minimum of any one item
\$20 minimum on BofA & M.C.
Add \$1.00 for shipping plus \$.85 if COD
California Residents add 6% Sales Tax

Orders from Foreign countries add appropriate postage

Circle 88 on reader service card

When you install a B-T Booster outside, you get a lot of new boosters inside.

The service technician's job is a tough one. Customers are always grumbling about the high cost of TV service calls. And they complain about poor reception—even when it's almost impossible to get a good signal.

But now and then a TV service technician wins one. And one of the products that can make him a winner, and create customer goodwill, is a Blonder-Tongue outdoor booster.

B-T Boosters can produce a dramatic improvement in picture quality, particularly on color and especially in difficult reception areas. After 25 years of making outdoor boosters, B-T is number one in sales, and enjoys the finest reputation for making

products of highest performance and reliability. B-T Boosters do cost a bit more than competition, but they perform and last longer. And that's what makes satisfied customers.

The VAULTER, for example, is the number one outdoor booster today in the B-T line... *and* in the entire industry. This ultra-high performance, all-channel amplifier offers the ideal combination of lowest possible noise figure (4.6dB, VHF; 7.0dB, UHF) and high gain (15dB). While it can't make unusable, snowy pictures perfect, it *can* reduce fading, loss of color, overcome cable loss and reduce lead-in cable noise. It can even feed more than one TV set from the same antenna in fringe reception areas. It

has separate U/V inputs and a coax output. Finally, it's specially designed for lightning prone areas.

The B-T line consists of 5 all-channel models (including the popular VOYAGER); 5 VHF models and 4 UHF boosters (the ABLE-U2b is a favorite).

See your B-T distributor for details. And see why you can count on boosters inside, when you install B-T Boosters outside. Blonder-Tongue Laboratories, Inc., One Jake Brown Road, Old Bridge, N.J. 08857.



BLONDER-TONGUE



Circle 68 on reader service card

Experience is the best teacher. You might settle for any CB first time around. Understandably. A lot of people think they're all pretty much alike. But you'll soon discover that, like everything else, there are exceptions.

Ask the pros. America's long distance truckers. These guys talk CB day in and day out. And they demand the best. That's why truckers refer to the Cobra 29 as "The Diesel Mobile."

Listen to Cobra. You'll hear a big difference. Because the Cobra 29 gives you features which assure crystal clear reception. Like switchable noise limiting and blanking, to cut out practically all pulse and ignition interference. Add squelch control and RF gain and you've got exceptional—adjustable—receiver clarity. Even in the heaviest CB traffic. You also get Delta Tuning which makes up for the other guy, because even off-frequency transmitters are pulled in. Perfectly.

Talk to Cobra. And you know you're punching through. One glance at the

29's over-sized illuminated meter tells you just how much power you're punching out and pulling in. For voice modulation the DynaMike delivers at 100%. Same way with power: The 29 transmits at maximum power levels.

Sooner or later you'll get a Cobra. And you'll get engineering and craftsmanship second to none. Performance that will make your first CB seem obsolete. Reliability and durability that have set standards for the industry. Above all, you'll get power. The power to punch through loud and clear like nothing else. Because when it comes to CB radio, nothing punches through loud and clear like a Cobra.



Punches through loud and clear.

Cobra Communications, Products of Dynascan Corp.
1801 W. Belle Plaine, Chicago, Illinois 60613

**IF YOUR FIRST CB ISN'T A COBRA
YOUR SECOND ONE WILL BE.**



Circle 4 on reader service card